



INDUSTRIAL  
CONNECTIVITY

# 工业连接器



## 公司简介

天津吉诺科技有限公司成立于2010年9月，坐落于天津市静海经济开发区，注册资金4000万元，占地面积约40000平方米，建筑面积18000平方米，现有员工600余人，在国内设立有17家销售分公司，销售业务触达30余个国家。

吉诺科技自成立以来，紧随国家产业发展步伐，保持初心，全心致力于创新研发，是国家级高新技术企业、天津市“专精特新”中小企业、天津市瞪羚企业、天津市科技领军企业，拥有自主核心知识产权。研发生产的高新技术产品荣获多项国家专利，其中包括发明专利17件，实用新型专利47件，外观设计专利17件。公司正在运行的《质量管理体系认证》《环境管理体系认证》《职业健康管理体系认证》历年来持续有效，众多产品取得了国内外相关认证如UL、CE、FCC等。

吉诺科技致力于成为工业连接与智慧感知领域的领军者，以创新技术和专业服务给予用户先进的产品和卓越的解决方案。公司四大主要业务板块——工业连接、工业传感、工业通讯和工业工程，依托于GSEE-TECH品牌工业自动化元器件和系统解决方案的专业技术，为实现智能精细化生产、透明智慧工厂提升新质生产力水平提供了强有力的支撑。

融合智慧，激发创新，铸就和谐共进的吉诺精神，是天津吉诺科技有限公司的企业灵魂，它不仅是我們不断前行的动力，也是我们服务客户、推动企业发展的核心所在。

天津吉诺科技有限公司，以引领科技潮流为愿景，专注于为产业发展注入创新动力。我们坚定信念，立志成为行业的领军企业，推动技术前沿的不断发展。吉诺科技始终秉持技术创新的理念，紧跟行业发展趋势，以领先的技术实力，推动产业升级。同时致力于将吉诺科技打造成为行业领军企业，为我国工业自动化贡献一份力量。

吉诺科技有限公司，秉承“诚信为本，客户至上”的服务宗旨，始终将诚信作为企业发展的基石。我们深知，诚信是企业立足市场的根本，更是企业与客户建立长期合作关系的桥梁。在这里，我们承诺为您提供优质的产品和服务，让您感受到我们的真诚与用心。

与此同时，我们始终坚持“勇于担当，追求共赢”的发展理念。面对挑战，我们不惧困难，敢于担当，全力以赴为客户创造价值。我们相信，只有实现客户、员工、企业和社会的共赢，才能推动公司持续发展，为社会贡献力量。吉诺科技，期待与您携手共创美好未来！



# 目录

## 内容说明

◎ M5	A00~06
◎ M8	B00~16
◎ M12	C00~64
◎ 7/8"	D00~18
◎ M16	E00~20
◎ M17	F00~08
◎ M23	G00~32
◎ M40	H00~06
◎ 1-3/8"	I00~04
◎ 阀式连接器	J00~14
◎ 分线器&分线盒	K00~24
◎ DeviceNet™	L00~14
◎ PROFIBUS-DP	M00~20
◎ CC-Link	N00~06
◎ Ethernet,Profinet, Ethercat	O01~06

# 目录

## 内容说明

001~005

◎ 电缆选型

---

006~007

◎ 电缆安装说明

---

008

◎ 线缆线规对照表

---

**P00=PVC (标准色: 黑色)**

PVC电缆适用于一般机械应力的应用场合包括包装机械, 装配线, 生产线。固定场合使用。

**P10=PUR | PVC (标准色: 黑色)**

具有PUR电缆外皮, PVC绝缘线芯的P10电缆有很好的耐油性, 耐化学腐蚀性以及优良的耐磨性, 适用于机床行业, 装配线, 生产线以及金属切削生产线。

**P11=PUR, 无卤素, 无PVC (标准色: 黄色)**

PUR外皮对油, 润滑油, 冷却剂以及其它侵蚀剂有很好的抵抗力。该电缆的使用温度能够达到105°C。这种电缆具有一定的柔性因此能够用于一些活动装置及器械上面, 可拖链。

**P13=PUR| PP (标准色: 黑色)**

PUR外皮, PP绝缘层,耐温范围从 -40°C to +80°C。耐油,耐磨,高柔性,不含卤素、硅、PVC和LABS可适用拖链场合,折弯寿命大于500万次,符合RoHS。

**P01=照射PVC (标准色: 橙色)**

照射PVC电缆相比较普通的PVC, 在机械强度, 耐化学性以及耐磨性等性能上都有很大的提高, 另外照射PVC在较高温度下仍然能够保持稳定, 从而具有优良的抗电火花, 焊渣性能,在离焊枪30cm以上距离, 可以安全的使用。适用于各种焊接场合的应用。

**P21=照射PUR | PE, 无卤素, 无PVC (标准色: 橙色)**

照射PUR电缆相比较普通的PUR 电缆在机械强度, 耐磨性上都有了显著的提高, 具有耐油性, 另外还具有优良的耐焊接火花性能,在离焊枪30cm以上的距离可以安全的使用。使用温度能够达到100°C。适用于机器人, 焊接机器人, 机床, 装配线和金属加工等生产领域, 可拖链。

**GSC=PUR| PP (标准色: 黑色)**

PUR外皮, PP绝缘层,耐温范围从 -40°C to +80°C。耐油,耐磨,高柔性,不含卤素、硅、PVC和LABS可适用拖链场合,折弯寿命大于500万次,阻燃,防飞溅,cULus 认证,符合RoHS。(规格仅有3、4、5芯0.34mm<sup>2</sup>)

**GSY=PUR| PP (标准色: 灰色)**

PUR外皮, PP绝缘层,耐温范围从 -40°C to +80°C。耐油,耐磨,高柔性,不含卤素、硅、PVC和LABS可适用拖链场合,折弯寿命大于500万次,阻燃,防飞溅,cULus 认证,符合RoHS。(规格仅有3、4、5芯0.34mm<sup>2</sup>)

**S10=屏蔽型PVC (标准色: 黑色)**

除普通PVC电缆适用的应用环境之外, 还常常用于现场有电磁波等电噪声干扰的应用环境。固定场合使用。

**S13=PUR| PP高柔 低烟无卤带屏蔽, 屏蔽 (标准色: 黑色)**

耐温范围从 -40°C to +80°C。不含PVC和卤素,能够耐油也具有一定的自熄性, 能够用于拖链场合。常常用于现场有电磁波等电噪声干扰的应用环境,适用于机器人, 机床, 装配线和金属加工等生产领域。





## ■ M5 工业连接器

# M5连接器命名规则

## 预铸式连接器命名规则

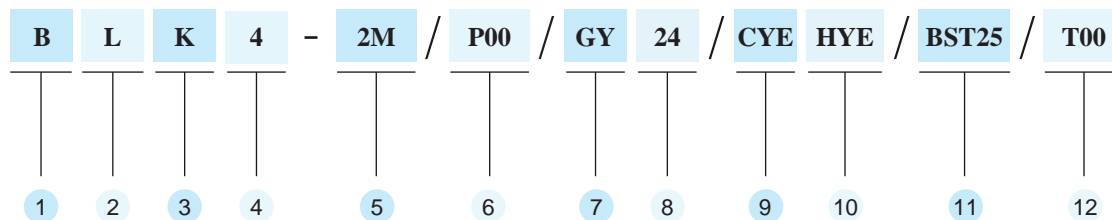

- |   |   |   |
|---|---|---|
| <p>1 B M5X0.5 连接器</p> <p>2 Blank 直线型<br/>L 直角型</p> <p>3 K 孔座<br/>Z 针座</p> <p>4 针脚数</p> <p>5 电缆长度 [m]</p> <p>6 电缆材质代码<br/>参考003页电缆材质说明</p> | <p>7 电缆颜色<br/>Blank 标准色黑色<br/>YE 黄色 (定制化)<br/>GY 灰色 (定制化)</p> <p>8 电缆线规<br/>Blank 26AWG 标准线规<br/>24 24AWG</p> <p>9 针托颜色<br/>Blank 标准色黑色</p> | <p>10 预铸接头颜色<br/>Blank 标准色黑色<br/>HYE 黄色预铸接头<br/>HBU 蓝色预铸接头</p> <p>11 标识套 (不带标记牌)<br/>双端插件默认两个, 单端默认一个<br/>Blank 标准不带标识套<br/>BST25 25mm长标识套</p> <p>12 特殊规格定制</p> |
|---|---|---|

### 单端预铸举例



BK3-\*M/P00



BLZ3-\*M/P00

### 双端预铸举例

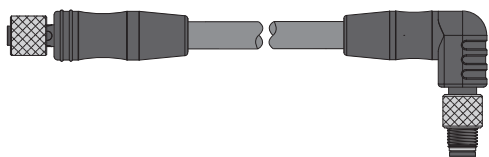

BK4 BLZ4-\*M/P00

## 法兰连接器命名规则

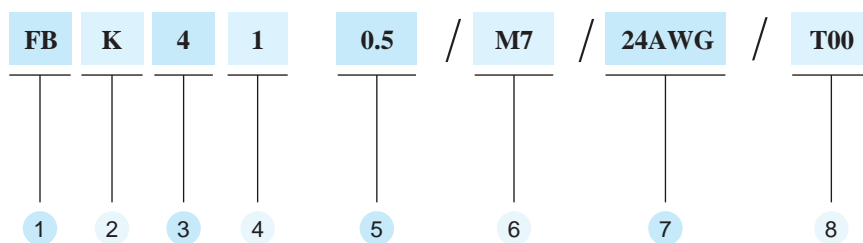

1 FB M5X0.5 法兰式连接器

2 K 孔座  
Z 针座

3 针脚数  
编号分配

4 连接方式  
1 前端拧紧型  
2 后端拧紧型

5 0.5尾线长度0.5m  
L 导线焊接触点  
P PCB焊接触点

6 连接方式  
Blank M5X0.5  
M7 M7X0.75

7 线规  
Blank 26AWG 标准线规  
24 24AWG

8 特殊规格定制

## 3针/4针M5预铸式连接器

- 预铸接头:TPU材质,黑色
- 锁紧螺母:黄铜镀镍
- 针托:TPU材质,黑色
- 触点:黄铜镀金
- 密封圈:FPM/FKM
- 防护等级:IP67
- 电流等级:1A
- 电压等级:60V
- 绝缘电阻: $\geq 10^9 \Omega$
- 接触电阻: $\leq 5m\Omega$
- 污染等级:3
- 使用环境温度: $-40 \sim +80^\circ\text{C}$
- 可插拔寿命:最小100次
- 最大线缆外径:  $\varnothing 3.8$



预铸式连接器	型号	订货号	电缆	针脚编号分布
直线孔座BK..** 	BK3-2M/P00 BK3-5M/P00 BK3-10M/P00	10100400 10100401 10100402	黑色PVC电缆 3x26AWG (3x0.14mm <sup>2</sup> ) $\varnothing 3.8\text{mm}$ 电缆型号: 58018151-*M	孔座 1.BN 3.BU 4.BK
直角孔座BLK..** 	BLK3-2M/P00 BLK3-5M/P00 BLK3-10M/P00	10100403 10100404 10100405		针座 1.BN 3.BU 4.BK
直线针座BZ..** 	BZ3-2M/P00 BZ3-5M/P00 BZ3-10M/P00	10100406 10100407 10100408	黑色PVC电缆 3x26AWG (3x0.14mm <sup>2</sup> ) $\varnothing 3.8\text{mm}$ 电缆型号: 58018151-*M	孔座 1.BN 3.BU 4.BK
直角针座BLZ..** 	BLZ3-2M/P00 BLZ3-5M/P00 BLZ3-10M/P00	10100409 10100410 10100411		针座 1.BN 3.BU 4.BK
直线孔座BK..** 	BK4-2M/P00 BK4-5M/P00 BK4-10M/P00	10100412 10100413 10100414	黑色PVC电缆 4x26AWG (4x0.14mm <sup>2</sup> ) $\varnothing 3.8\text{mm}$ 电缆型号: 58019151-*M	孔座 1.BN 2.WH 3.BU 4.BK
直角孔座BLK..** 	BLK4-2M/P00 BLK4-5M/P00 BLK4-10M/P00	10100415 10100416 10100417		针座 1.BN 2.WH 3.BU 4.BK
直线针座BZ..** 	BZ4-2M/P00 BZ4-5M/P00 BZ4-10M/P00	10100418 10100419 10100420	黑色PVC电缆 4x26AWG (4x0.14mm <sup>2</sup> ) $\varnothing 3.8\text{mm}$ 电缆型号: 58019151-*M	孔座 1.BN 2.WH 3.BU 4.BK
直角针座BLZ..** 	BLZ4-2M/P00 BLZ4-5M/P00 BLZ4-10M/P00	10100421 10100422 10100423		针座 1.BN 2.WH 3.BU 4.BK

\* 标准长度为2/5/10米,可订制任意长度

\*\* 标准锁紧螺母材质为黄铜镀镍

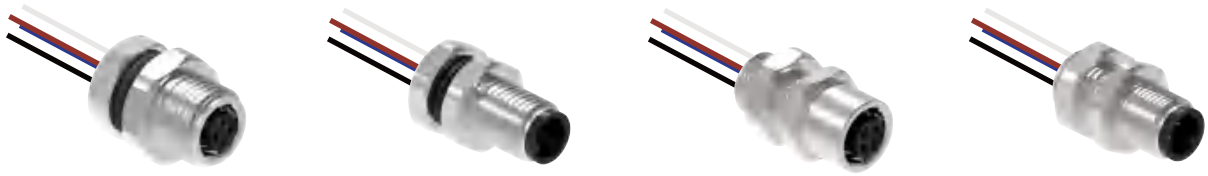

法兰连接器	型号	订货号	特性描述	针脚编号分布
<p>M5前端锁紧,出线 孔座</p>	<p>FBK31-0.5/M7 FBK31-1.0/M7</p>	<p>10100430 10100431</p>	<p>3x26AWG (3x0.14mm<sup>2</sup>) PVC 105°C 60V 1A</p>	<p>孔座</p> <p>1.BN 3.BU 4.BK</p>
<p>M5前端锁紧,出线 针座</p>	<p>FBZ31-0.5 FBZ31-1.0</p>	<p>10100432 10100433</p>	<p>3x26AWG (3x0.14mm<sup>2</sup>) PVC 105°C 60V 1A</p>	<p>针座</p> <p>1.BN 3.BU 4.BK</p>
<p>M5后端锁紧,出线 孔座</p>	<p>FBK32-0.5 FBK32-1.0</p>	<p>10100434 10100435</p>	<p>3x26AWG (3x0.14mm<sup>2</sup>) PVC 105°C 60V 1A</p>	<p>孔座</p> <p>1.BN 3.BU 4.BK</p>
<p>M5后端锁紧,出线 针座</p>	<p>FBZ32-0.5 FBZ32-1.0</p>	<p>10100436 10100437</p>	<p>3x26AWG (3x0.14mm<sup>2</sup>) PVC 105°C 60V 1A</p>	<p>针座</p> <p>1.BN 3.BU 4.BK</p>

## M5法兰连接器

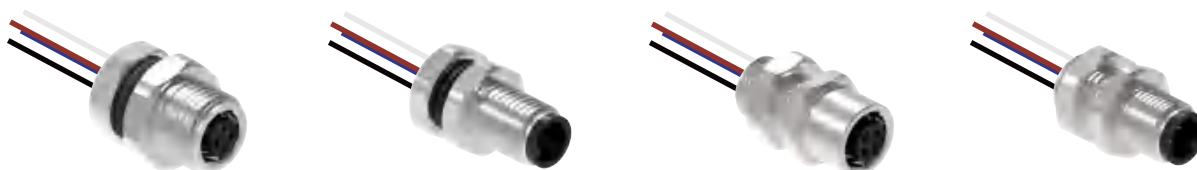

法兰连接器	型号	订货号	特性描述	针脚编号分布
<p>M5前端锁紧,出线 孔座</p>	<p>FBK41-0.5/M7 FBK41-1.0/M7</p>	<p>10100438 10100439</p>	<p>4x26AWG (4x0.14mm<sup>2</sup>) PVC 105°C 60V 1A</p>	<p>孔座</p> <p>1.BN 2.WH 3.BU 4.BK</p>
<p>M5前端锁紧,出线 针座</p>	<p>FBZ41-0.5 FBZ41-1.0</p>	<p>10100440 10100441</p>	<p>4x26AWG (4x0.14mm<sup>2</sup>) PVC 105°C 60V 1A</p>	<p>针座</p> <p>1.BN 2.WH 3.BU 4.BK</p>
<p>M5后端锁紧,出线 孔座</p>	<p>FBK42-0.5 FBK42-1.0</p>	<p>10100442 10100443</p>	<p>4x26AWG (4x0.14mm<sup>2</sup>) PVC 105°C 60V 1A</p>	<p>孔座</p> <p>1.BN 2.WH 3.BU 4.BK</p>
<p>M5后端锁紧,出线 针座</p>	<p>FBZ42-0.5 FBZ42-1.0</p>	<p>10100444 10100445</p>	<p>4x26AWG (4x0.14mm<sup>2</sup>) PVC 105°C 60V 1A</p>	<p>针座</p> <p>1.BN 2.WH 3.BU 4.BK</p>

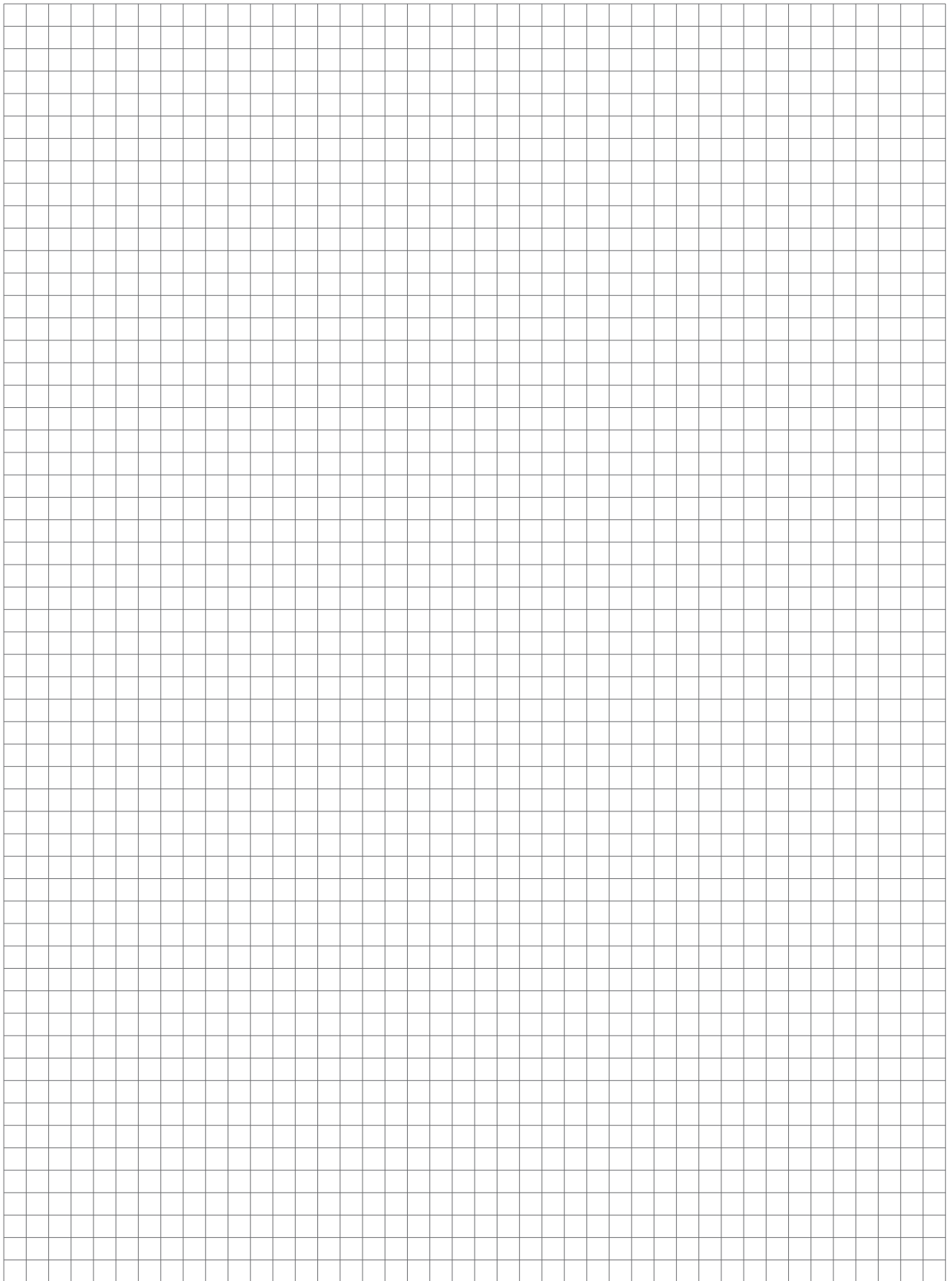
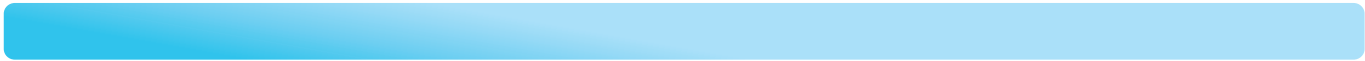



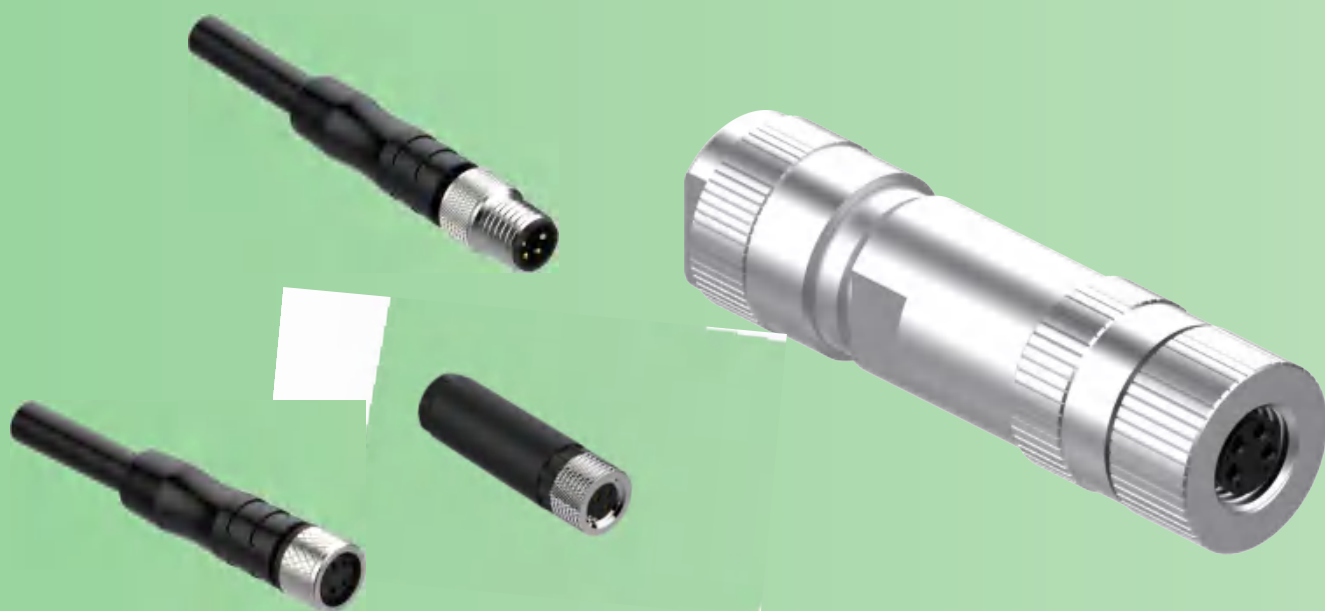

## ■ M8 工业连接器

# M8/Ø8连接器型号命名规则

## 预铸式连接器命名规则

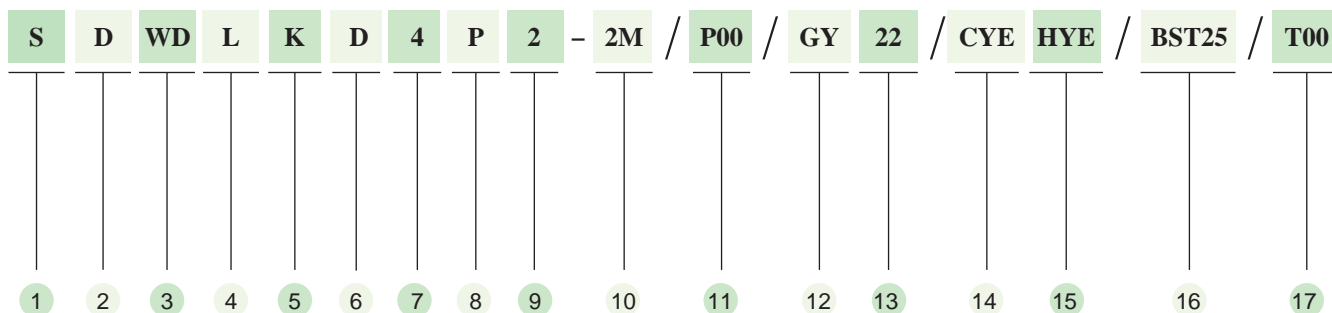

- |  |  |   |
|--|--|---|
| <p>1 S M8X1连接器<br/>R Ø8连接器</p> <p>2 Blank A-code<br/>B B-code<br/>D D-code<br/>P P-code<br/>I A-code<br/>(Ethernet、Profinet)</p> <p>3 Blank 黄铜镀镍螺母<br/>WD 不锈钢螺母<br/>AF 塑料螺母</p> <p>4 Blank 直线型<br/>L 直角型</p> <p>5 K 孔座<br/>Z 针座</p> <p>6 Blank 标准结构<br/>D 短型结构</p> | <p>7 针脚数</p> <p>8 LED指示<br/>P PNP<br/>N NPN</p> <p>9 指示灯数量</p> <p>10 电缆长度[m]</p> <p>11 电缆材质代码</p> <p>12 电缆颜色<br/>Blank 标准色黑色<br/>YE 黄色<br/>GY 灰色<br/>OR 橙色</p> | <p>13 电缆线规<br/>Blank 3-4pin 24AWG<br/>B扣5pin 22AWG<br/>6-8pin 26AWG<br/>22 22AWG<br/>26 26AWG</p> <p>14 针托颜色<br/>Blank 标准色黑色</p> <p>15 预铸接头颜色<br/>Blank 标准色黑色<br/>HGY 灰色预铸接头<br/>HBU 蓝色预铸接头<br/>HYE 黄色预铸接头</p> <p>16 标识套 (不带标记牌)<br/>双端插件默认两个, 单端默认一个<br/>Blank 标准不带标识套<br/>BST25 25mm长标识套</p> <p>17 特殊规格定制</p> |
|--|--|---|

## 双端预铸型号举例

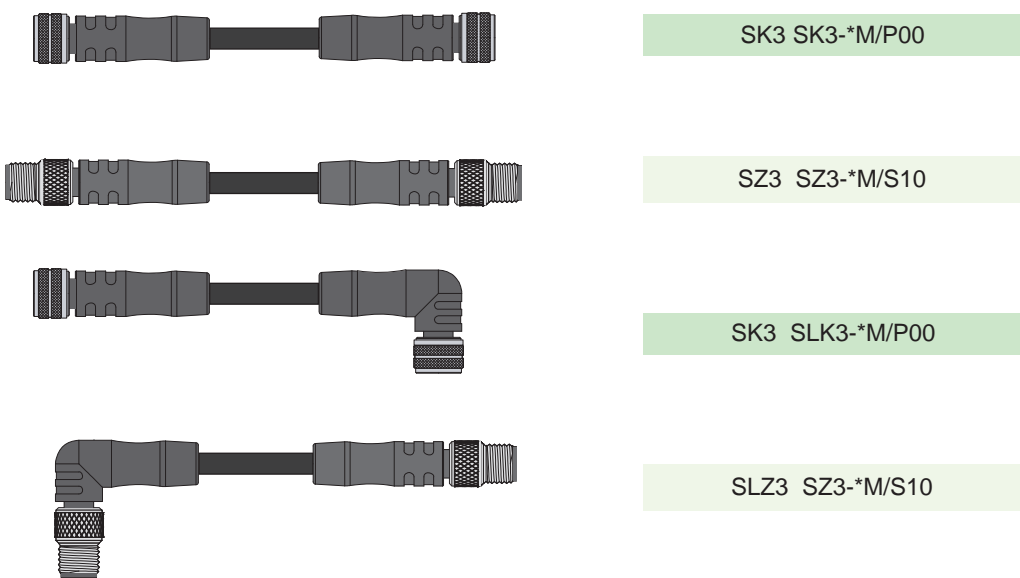

## 法兰连接器命名规则

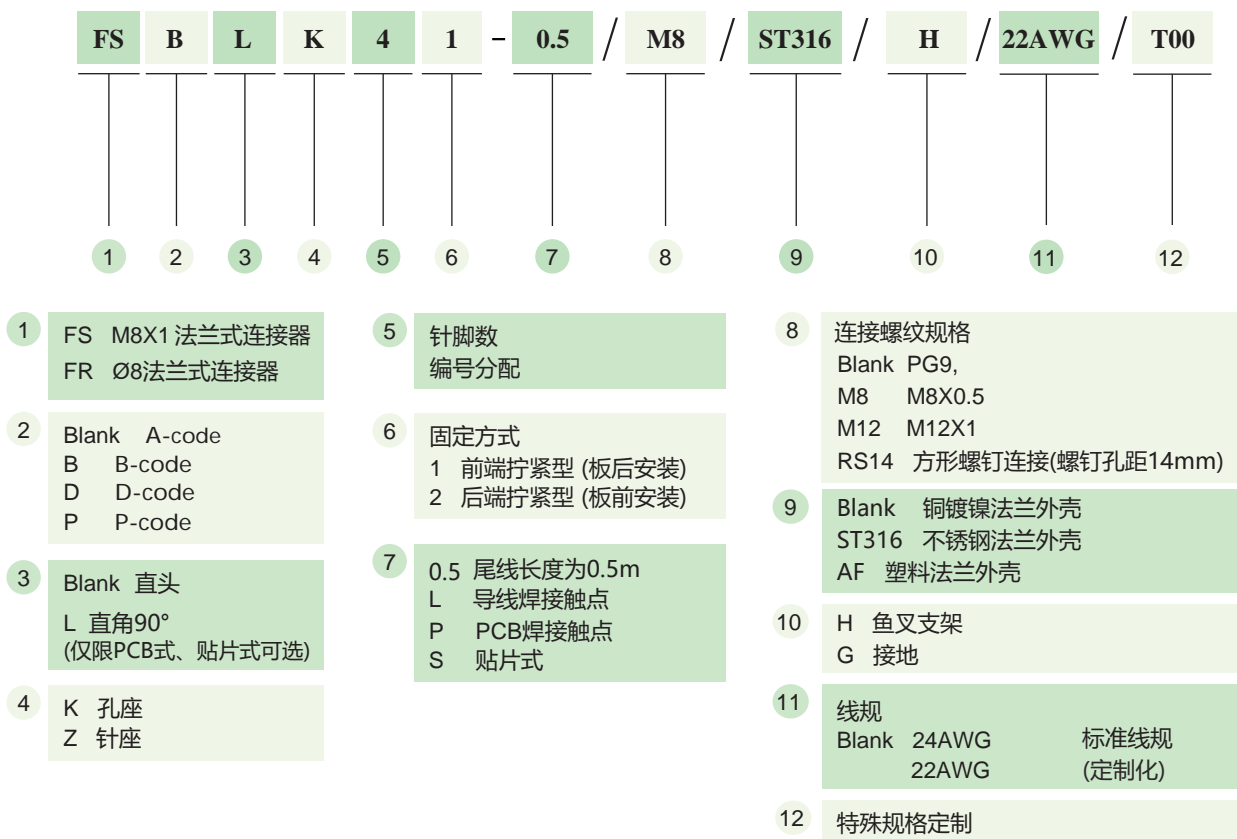

## 现场可接线连接器命名规则

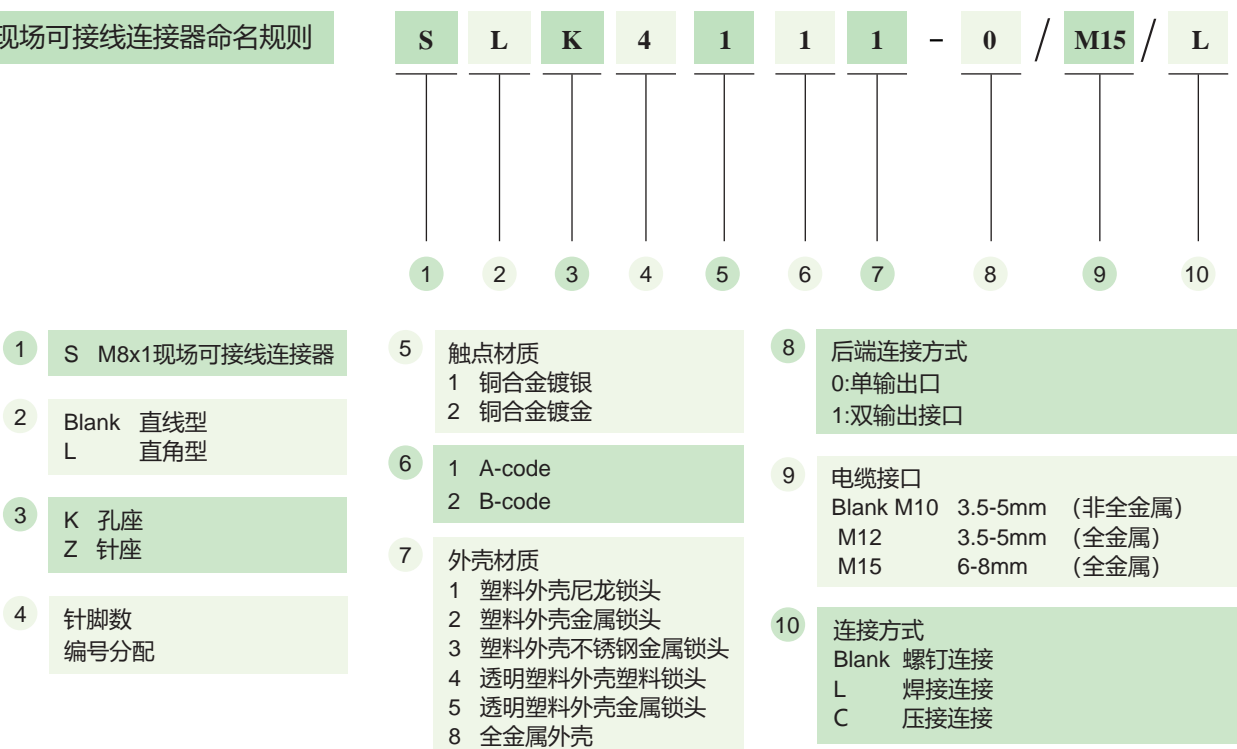

## 3针/4针M8预铸式连接器

- 预铸接头:TPU材质,黑色
- 锁紧螺母:黄铜镀镍
- 针托:TPU材质,黑色
- 触点:黄铜镀金
- 密封圈:FPM/FKM
- 防护等级:IP67
- 电流等级:4A
- 电压等级:3针60V,4针30V
- 绝缘电阻: $\geq 10^9 \Omega$
- 接触电阻: $\leq 5m\Omega$
- 污染等级:3
- 使用环境温度:-40~+80°C
- 可插拔寿命:最小100次
- 电缆最大外径: 5.6mm



预铸式连接器	型号	订货号	电缆	针脚编号分布
直线孔座SK..** 	SK3-2M/P00 SK3-5M/P00 SK3-10M/P00	10021000 10021001 10021002	黑色PVC电缆 3x24AWG (3x0.25mm <sup>2</sup> ) Ø4.4mm 电缆型号: 580E2351-*M	孔座 
直角孔座SLK..** 	SLK3-2M/P00 SLK3-5M/P00 SLK3-10M/P00	10021020 10021021 10021022		针座 
直线针座SZ..** 	SZ3-2M/P00 SZ3-5M/P00 SZ3-10M/P00	10021040 10021041 10084603	黑色PVC电缆 3x24AWG (3x0.25mm <sup>2</sup> ) Ø4.4mm 电缆型号: 580E2351-*M	孔座 
直角针座SLZ..** 	SLZ3-2M/P00 SLZ3-5M/P00 SLZ3-10M/P00	10021060 10021061 10084604		针座 
直线孔座SK..** 	SK4-2M/P00 SK4-5M/P00 SK4-10M/P00	10021010 10021011 10021012	黑色PVC电缆 4x24AWG (4*0.25mm <sup>2</sup> ) Ø4.4mm 电缆型号: 580E1351-*M	孔座 
直角孔座SLK..** 	SLK4-2M/P00 SLK4-5M/P00 SLK4-10M/P00	10021030 10021113 10021032		针座 
直线针座SZ..** 	SZ4-2M/P00 SZ4-5M/P00 SZ4-10M/P00	10021050 10021156 10084605	黑色PVC电缆 4x24AWG (4x0.25mm <sup>2</sup> ) Ø4.4mm 电缆型号: 580E1351-*M	孔座 
直角针座SLZ..** 	SLZ4-2M/P00 SLZ4-5M/P00 SLZ4-10M/P00	10021070 10084606 10084607		针座 

\* 标准长度为2/5/10米,可订制任意长度

\*\* 标准锁紧螺母材质为黄铜镀镍

## 5针/6针M8预铸式连接器

- 预铸接头:TPU材质,黑色
- 锁紧螺母:黄铜镀镍
- 针托:TPU材质,黑色
- 触点:黄铜镀金
- 密封圈:FPM/FKM
- 防护等级:IP67
- 电流等级:5芯3A,6芯2A
- 电压等级:30V
- 绝缘电阻: $\geq 10^9 \Omega$
- 接触电阻: $\leq 5m\Omega$
- 污染等级:3
- 使用环境温度:-40~+80°C
- 可插拔寿命:最小100次
- 电缆最大外径: 5.6mm



预铸式连接器	型号	订货号	电缆	针脚编号分布
<b>直线孔座SBK..**</b> 	SBK5-2M/P00 SBK5-5M/P00 SBK5-10M/P00	10021355 10021356 10021357	黑色PVC电缆 5x22AWG (5x0.34mm <sup>2</sup> ) Ø5.2mm 58610231-*M	孔座 
<b>直角孔座SLBK..**</b> 	SBLK5-2M/P00 SBLK5-5M/P00 SBLK5-10M/P00	10028430 10021016 10021019	黑色PVC电缆 5x22AWG (5x0.34mm <sup>2</sup> ) Ø5.2mm 58610231-*M	1.BN 2.WH 3.BU 4.BK 5.GY 
<b>直线针座SBZ..**</b> 	SBZ5-2M/P00 SBZ5-5M/P00 SBZ5-10M/P00	10021361 10021362 10021363	黑色PVC电缆 5x22AWG (5x0.34mm <sup>2</sup> ) Ø5.2mm 58610231-*M	针座 
<b>直角针座SLBZ..**</b> 	SBLZ5-2M/P00 SBLZ5-5M/P00 SBLZ5-10M/P00	10021027 10021028 10021029	黑色PVC电缆 5x22AWG (5x0.34mm <sup>2</sup> ) Ø5.2mm 58610231-*M	1.BN 2.WH 3.BU 4.BK 5.GY 
<b>直线孔座SK..**</b> 	SK6-2M/P00 SK6-5M/P00 SK6-10M/P00	10021367 12500267 10021368	黑色PVC电缆 6x26AWG (6x0.14mm <sup>2</sup> ) Ø5.0mm 58528911-*M	孔座 
<b>直角孔座SLK..**</b> 	SLK6-2M/P00 SLK6-5M/P00 SLK6-10M/P00	10021369 10021370 10021371	黑色PVC电缆 6x26AWG (6x0.14mm <sup>2</sup> ) Ø5.0mm 58528911-*M	1.BN 2.WH 3.BU 4.BK 5.GY 6.PK 
<b>直线针座SZ..**</b> 	SZ6-2M/P00 SZ6-5M/P00 SZ6-10M/P00	10021372 10021373 10021374	黑色PVC电缆 6x26AWG (6x0.14mm <sup>2</sup> ) Ø5.0mm 58528911-*M	针座 
<b>直角针座SLZ..**</b> 	SLZ6-2M/P00 SLZ6-5M/P00 SLZ6-10M/P00	10021375 10021376 10021377	黑色PVC电缆 6x26AWG (6x0.14mm <sup>2</sup> ) Ø5.0mm 58528911-*M	1.BN 2.WH 3.BU 4.BK 5.GY 6.PK 

\* 标准长度为2/5/10米,可订制任意长度

\*\* 标准锁紧螺母材质为黄铜镀镍

## 8针M8预铸式连接器

- 预铸接头:TPU材质,黑色
- 锁紧螺母:黄铜镀镍
- 针托:TPU材质,黑色
- 触点:黄铜镀金
- 密封圈:FPM/FKM
- 防护等级:IP67
- 电流等级:1.5A
- 电压等级:30V
- 绝缘电阻: $\geq 10^9 \Omega$
- 接触电阻: $\leq 5m\Omega$
- 污染等级:3
- 使用环境温度: $-40 \sim +80^\circ\text{C}$
- 可插拔寿命:最小100次
- 电缆最大外径:5.6mm



预铸式连接器	型号	订货号	电缆	针脚编号分布
直线孔座SK..** 	SK8-2M/P00 SK8-5M/P00 SK8-10M/P00	10023347 10021378 10021379	黑色PVC电缆 8x26AWG (8x0.14mm <sup>2</sup> ) Ø5.0mm 电缆型号: 58020151-*M	孔座 
直角孔座SLK..** 	SLK8-2M/P00 SLK8-5M/P00 SLK8-10M/P00	10021380 10021381 10021382		1.WH 2.BN 3.GN 4.YE 5.GY 6.PK 7.BU 8.RD
直线针座SZ..** 	SZ8-2M/P00 SZ8-5M/P00 SZ8-10M/P00	10023379 10021383 10021384	黑色PVC电缆 8x26AWG (8x0.14mm <sup>2</sup> ) Ø5.0mm 电缆型号: 58020151-*M	针座 
直角针座SLZ..** 	SLZ8-2M/P00 SLZ8-5M/P00 SLZ8-10M/P00	10021385 10021386 10021387		1.WH 2.BN 3.GN 4.YE 5.GY 6.PK 7.BU 8.RD

\* 标准长度为2/5/10米,可订制任意长度

\*\* 标准锁紧螺母材质为黄铜镀镍

## 3针/4针Ø8预铸式连接器

- 预铸接头:TPU材质,黑色
- 针托:TPU材质,黑色
- 触点:黄铜镀金
- 密封圈:FPM/FKM
- 防护等级:IP67
- 电流等级:4A
- 电压等级:3针60V,4针30V
- 绝缘电阻: $\geq 10^9 \Omega$
- 接触电阻: $\leq 5m\Omega$
- 污染等级:3
- 使用环境温度:-40~+80°C
- 可插拔寿命:最小100次



预铸式连接器	型号	订货号	电缆	针脚编号分布
直线孔座RK..** 	RK3-2M/P00 RK3-5M/P00 RK3-10M/P00	10022000 10022006 10022007	黑色PVC电缆 3x24AWG (3x0.25mm <sup>2</sup> ) Ø4.4mm : 电缆型号 580E2351-*M	孔座  1.BN 3.BU 4.BK
直角孔座RLK..** 	RLK3-2M/P00 RLK3-5M/P00 RLK3-10M/P00	10022020 10022024 10025172	黑色PVC电缆 3x24AWG (3x0.25mm <sup>2</sup> ) Ø4.4mm : 电缆型号 580E2351-*M	孔座  1.BN 3.BU 4.BK
直线针座RZ..** 	RZ3-2M/P00 RZ3-5M/P00 RZ3-10M/P00	10022042 10022043 10022044	黑色PVC电缆 3x24AWG (3x0.25mm <sup>2</sup> ) Ø4.4mm : 电缆型号 580E2351-*M	针座  1.BN 3.BU 4.BK
直角针座RLZ..** 	RLZ3-2M/P00 RLZ3-5M/P00 RLZ3-10M/P00	10022060 10022063 10022064	黑色PVC电缆 3x24AWG (3x0.25mm <sup>2</sup> ) Ø4.4mm : 电缆型号 580E2351-*M	针座  1.BN 3.BU 4.BK
直线孔座RK..** 	RK4-2M/P00 RK4-5M/P00 RK4-10M/P00	10022010 10022011 10022012	黑色PVC电缆 4x24AWG (4x0.25mm <sup>2</sup> ) Ø4.4mm : 电缆型号 580E1351-*M	孔座  1.BN 2.WH 3.BU 4.BK
直角孔座RLK..** 	RLK4-2M/P00 RLK4-5M/P00 RLK4-10M/P00	10022030 10022033 10022034	黑色PVC电缆 4x24AWG (4x0.25mm <sup>2</sup> ) Ø4.4mm : 电缆型号 580E1351-*M	孔座  1.BN 2.WH 3.BU 4.BK
直线针座RZ..** 	RZ4-2M/P00 RZ4-5M/P00 RZ4-10M/P00	10022050 10022051 10022052	黑色PVC电缆 4x24AWG (4x0.25mm <sup>2</sup> ) Ø4.4mm : 电缆型号 580E1351-*M	针座  1.BN 2.WH 3.BU 4.BK
直角针座RLZ..** 	RLZ4-2M/P00 RLZ4-5M/P00 RLZ4-10M/P00	10022070 10022072 10022073	黑色PVC电缆 4x24AWG (4x0.25mm <sup>2</sup> ) Ø4.4mm : 电缆型号 580E1351-*M	针座  1.BN 2.WH 3.BU 4.BK

\* 标准长度为2/5/10米,可订制任意长度

\*\* 标准锁紧螺母材质为黄铜镀镍

## 3针/4针 M8 带LED指示灯型预铸式连接器

- 预铸接头:PBT,透明/PA6+GF
- 锁紧螺母:黄铜镀镍
- 针托:TPU材质,黑色
- 触点:黄铜镀金
- 密封圈:FPM/FKM
- 防护等级:IP67
- 电流等级:4A
- 电压等级:3针60VDC,4针30VDC
- 绝缘电阻: $\geq 10^9 \Omega$
- 正向电阻: $\leq 5m\Omega$
- 污染等级:3
- 使用环境温度: $-30 \dots +90^\circ\text{C}$
- 可插拔寿命:最小100次







预铸式连接器	型号	订货号	电缆	针脚编号分布
<p>M8直角孔座SK..**</p>	SK3P2-2M/P00 SK3P2-5M/P00 SK3P2-10M/P00	10021AAA 10021AAB 10021AAC	黑色PVC电缆 3x24AWG (3x0.25mm <sup>2</sup> ) Ø4.4mm 电缆型号: 580E2351-*M	<p>孔座</p> <p>1.BN 3.BU 4.BK</p>
<p>M8直角孔座SK..**</p>	SK4P2-2M/P00 SK4P2-5M/P00 SK4P2-10M/P00	1002126K 1002126V 1002125X	黑色PVC电缆 4x24AWG (4x0.25mm <sup>2</sup> ) Ø4.4mm 电缆型号: 580E1351-*M	<p>孔座</p> <p>1.BN 2.WH 3.BU 4.BK</p>
<p>M8直角孔座SLK..**</p>	SLK3P2-2M/P00 SLK3P2-5M/P00 SLK3P2-10M/P00	10021480 10021540 10021541	黑色PVC电缆 3x24AWG (3x0.25mm <sup>2</sup> ) Ø4.4mm 电缆型号: 580E2351-*M	<p>孔座</p> <p>1.BN 3.BU 4.BK</p>
<p>M8直角孔座SLK..**</p>	SLK4P2-2M/P00 SLK4P2-5M/P00 SLK4P2-10M/P00	10021490 10021542 10021543	黑色PVC电缆 4x24AWG (4x0.25mm <sup>2</sup> ) Ø4.4mm 电缆型号: 580E1351-*M	<p>孔座</p> <p>1.BN 2.WH 3.BU 4.BK</p>

\* 标准长度为2/5/10米,可订制任意长度

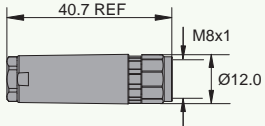
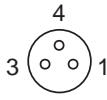
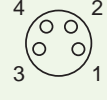
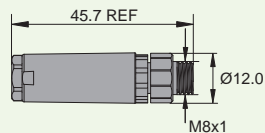
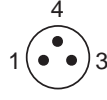
\*\* 标准锁紧螺母材质为黄铜镀镍

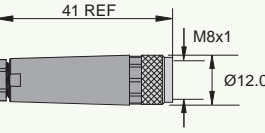
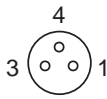
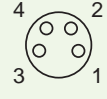
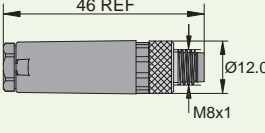
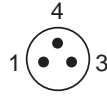





现场可接线连接器	型号	订货号	特性描述	针脚编号分布
M8x1 直线孔座 - 螺钉连接 	SK3211-0	10091622	PA6+GF,黑色/锁头 M10 电缆出线口 可连接的电缆外径范围: 3.5-5 mm 插孔尾部可连接的最大线:0.75mm <sup>2</sup> 螺钉连接 85°C, 60V, 4 A	
	SK4211-0	10091620	PA6+GF,黑色/锁头 M10 电缆出线口 可连接的电缆外径范围: 3.5-5 mm 插孔尾部可连接的最大线:0.75mm <sup>2</sup> 螺钉连接 85°C, 30V, 4 A	
M8x1 直线针座 - 螺钉连接 	SZ3211-0	10091621	PA6+GF,黑色/锁头 M10 电缆出线口 可连接的电缆外径范围: 3.5-5 mm 插针尾部可连接的最大线:0.75mm <sup>2</sup> 螺钉连接 85°C, 60V, 4 A	
	SZ4211-0	10091623	PA6+GF,黑色/锁头 M10 电缆出线口 可连接的电缆外径范围: 3.5-5 mm 插针尾部可连接的最大线:0.75mm <sup>2</sup> 螺钉连接 85°C, 30V, 4 A	
M8x1 直线孔座 - 螺钉连接 	SK3212-0	10091500	PA6+GF,黑色/铜锌合金锁头 M10 电缆出线口 可连接的电缆外径范围: 3.5-5 mm 插孔尾部可连接的最大线:0.75mm <sup>2</sup> 螺钉连接 85°C, 60V, 4 A	
	SK4212-0	10091501	PA6+GF,黑色/铜锌合金锁头 M10 电缆出线口 可连接的电缆外径范围: 3.5-5 mm 插孔尾部可连接的最大线:0.75mm <sup>2</sup> 螺钉连接 85°C, 30V, 4 A	
M8x1 直线针座 - 螺钉连接 	SZ3212-0	10091502	PA6+GF,黑色/铜锌合金锁头 M10 电缆出线口 可连接的电缆外径范围: 3.5-5 mm 插针尾部可连接的最大线:0.75mm <sup>2</sup> 螺钉连接 85°C, 60V, 4 A	
	SZ4212-0	10091503	PA6+GF,黑色/铜锌合金锁头 M10 电缆出线口 可连接的电缆外径范围: 3.5-5 mm 插针尾部可连接的最大线:0.75mm <sup>2</sup> 螺钉连接 85°C, 30V, 4 A	

## 3针/4针M8现场可接线连接器

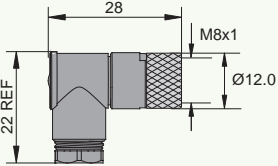
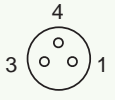
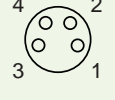
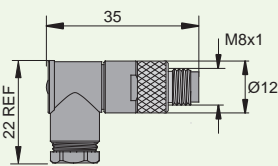
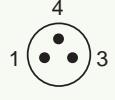

现场可接线连接器	型号	订货号	特性描述	针脚编号分布
M8x1 直角孔座 - 螺钉连接 	SLK3212-0	10091512	PA6+GF/黑色,铜锌合金锁头 M10 电缆出线口 可连接的电缆外径范围: 3.5-5 mm 插孔尾部可连接最大线芯: 0.34mm <sup>2</sup> 螺钉连接 85°C, 60V, 4 A	
	SLK4212-0	10091528	PA6+GF/黑色,铜锌合金锁头 M10 电缆出线口 可连接的电缆外径范围: 3.5-5 mm 插孔尾部可连接最大线芯: 0.34mm <sup>2</sup> 螺钉连接 85°C, 30V, 4 A	
M8x1 直角针座 - 螺钉连接 	SLZ3212-0	10091199	PA6+GF/黑色,铜锌合金锁头 M10 电缆出线口 可连接的电缆外径范围: 3.5-5 mm 插针尾部可连接最大线芯: 0.34mm <sup>2</sup> 螺钉连接 85°C, 60V, 4 A	
	SLZ4212-0	10091513	PA6+GF/黑色,铜锌合金螺母 M10 电缆出线口 可连接的电缆外径范围: 3.5-5 mm 插针尾部可连接最大线芯: 0.34mm <sup>2</sup> 螺钉连接 85°C, 30V, 4 A	

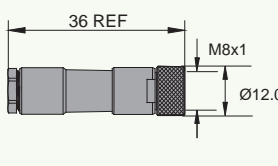
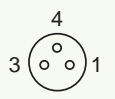
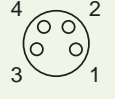
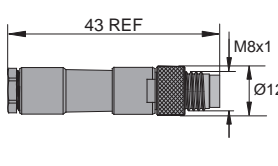
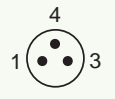

现场可接线连接器	型号	订货号	特性描述	针脚编号分布
M8x1 直角孔座 - 焊接连接 	SLK3212-0/L	10091508	PA6+GF/黑色,铜锌合金锁头 M10 电缆出线口 可连接的电缆外径范围: 3.5-5 mm 焊杯可焊接的最大线芯: 0.34mm <sup>2</sup> 焊接连接 85°C, 60V, 4 A	
	SLK4212-0/L	10091509	PA6+GF/黑色,铜锌合金锁头 M10 电缆出线口 可连接的电缆外径范围: 3.5-5 mm 焊杯可焊接的最大线芯: 0.34mm <sup>2</sup> 焊接连接 85°C, 30V, 4 A	
M8x1 直角针座 - 焊接连接 	SLZ3212-0/L	10091510	PA6+GF/黑色,铜锌合金锁头 M10 电缆出线口 可连接的电缆外径范围: 3.5-5 mm 焊杯可焊接的最大线芯: 0.34mm <sup>2</sup> 焊接连接 85°C, 60V, 4 A	
	SLZ4212-0/L	10091511	PA6+GF/黑色,铜锌合金螺母 M10 电缆出线口 可连接的电缆外径范围: 3.5-5 mm 焊杯可焊接的最大线芯: 0.34mm <sup>2</sup> 焊接连接 85°C, 30V, 4 A	
M8x1 直线孔座 - 焊接连接 	SK3212-0/L	10093040	PA6+GF,黑色/铜锌合金锁头 M10 电缆出线口 可连接的电缆外径范围: 3.5-5 mm 焊杯可焊接的最大线芯: 0.34mm <sup>2</sup> 焊接连接 85°C, 60V, 4 A	
	SK4212-0/L	10091505	PA6+GF,黑色/铜锌合金锁头 M10 电缆出线口 可连接的电缆外径范围: 3.5-5 mm 焊杯可焊接的最大线芯: 0.34mm <sup>2</sup> 焊接连接 85°C, 30V, 4 A	
M8x1 直线针座 - 焊接连接 	SZ3212-0/L	10091506	PA6+GF,黑色/铜锌合金锁头 M10 电缆出线口 可连接的电缆外径范围: 3.5-5 mm 焊杯可焊接的最大线芯: 0.34mm <sup>2</sup> 焊接连接 85°C, 60V, 4 A	
	SZ4212-0/L	10091507	PA6+GF,黑色/铜锌合金锁头 M10 电缆出线口 可连接的电缆外径范围: 3.5-5 mm 焊杯可焊接的最大线芯: 0.34mm <sup>2</sup> 焊接连接 85°C, 30V, 4 A	

## 3针/4针M8现场可接线连接器



现场可接线连接器	型号	订货号	特性描述	引脚编号分布
M8x1 直线孔座 - 螺钉连接 	SK3218-0/M15	10093087	PA6+GF/黑色插芯,铜镀镍外壳 M15 电缆出线口 可连接的电缆外径范围: 6-8 mm 插孔尾部可连接的最大线:0.75mm <sup>2</sup> 螺钉连接 85°C, 60V, 4 A	
	SK4218-0/M15	10093088	PA6+GF/黑色插芯,铜镀镍外壳 M15 电缆出线口 可连接的电缆外径范围: 6-8 mm 插孔尾部可连接的最大线:0.75mm <sup>2</sup> 螺钉连接 85°C, 30V, 4 A	
M8x1 直线针座 - 螺钉连接 	SZ3218-0/M15	10093090	PA6+GF/黑色插芯,铜镀镍外壳 M15 电缆出线口 可连接的电缆外径范围: 6-8 mm 插针尾部可连接的最大线:0.75mm <sup>2</sup> 螺钉连接 85°C, 60V, 4 A	
	SZ4218-0/M15	10093089	PA6+GF/黑色插芯,铜镀镍外壳 M15 电缆出线口 可连接的电缆外径范围: 6-8 mm 插针尾部可连接的最大线:0.75mm <sup>2</sup> 螺钉连接 85°C, 30V, 4 A	

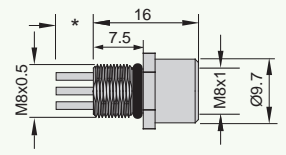
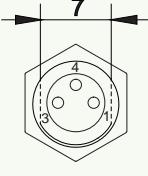
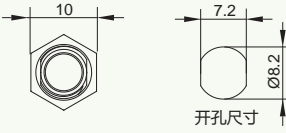
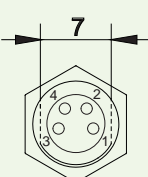
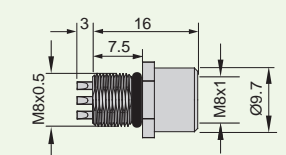
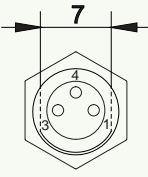
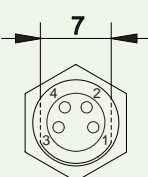
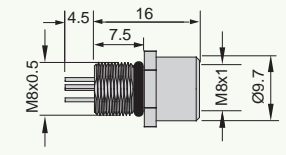
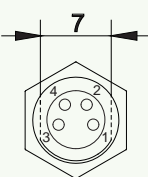

法兰连接器	型号	订货号	特性描述	针脚编号分布
M8x1 后端锁紧,出线 孔座 	FSK32-0.5/M8	10043000	3x24AWG(3x0.25mm <sup>2</sup> ) PVC 105°C 60V 4A	 1.BN 3.BU 4.BK
	FSK32-1.0/M8	10043112		
	FSK42-0.5/M8	10043010	4x24AWG(4x0.25mm <sup>2</sup> ) PVC 105°C 30V 4A	 1.BN 2.WH 3.BU 4.BK
	FSK42-1.0/M8	10043128		
M8x1 后端锁紧,焊接 孔座 	FSK32-L/M8	10043117	可焊接最大 22AWG(0.34mm <sup>2</sup> )电缆 105°C 60V 4A	 1.BN 3.BU 4.BK
	FSK42-L/M8	10043118	可焊接最大 22AWG(0.34mm <sup>2</sup> )电缆 105°C 30V 4A	 1.BN 2.WH 3.BU 4.BK
M8x1 后端锁紧,PCB 孔座 	FSK42-P/M8	10043132	4XØ0.6mm 105°C 30V 4A	

## 后端锁紧M8法兰连接器

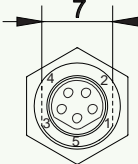
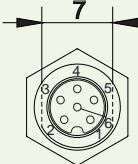
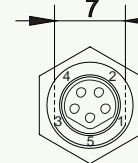
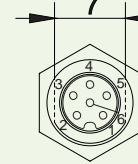
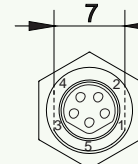
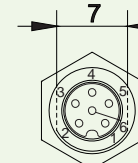

法兰连接器	型号	订货号	特性描述	针脚编号分布
M8x1 后端锁紧,出线 孔座	FSBK52-0.5/M8 FSBK52-1.0/M8	10048107 10048108	5x22AWG(5x0.34mm <sup>2</sup> ) PVC 105°C 30V 3A	 <ul style="list-style-type: none"> <li>1.BN</li> <li>2.WH</li> <li>3.BU</li> <li>4.BK</li> <li>5.GY</li> </ul>
	FSK62-0.5/M8 FSK62-1.0/M8	10048110 10048111	6x26AWG(6x0.14mm <sup>2</sup> ) PVC 105°C 24V 1A	 <ul style="list-style-type: none"> <li>1.BN</li> <li>2.WH</li> <li>3.BU</li> <li>4.BK</li> <li>5.GY</li> <li>6.PK</li> </ul>
M8x1 后端锁紧,焊接 孔座	FSBK52-L/M8	10048109	可焊接最大 22AWG(0.34mm <sup>2</sup> )电缆 105°C 30V 3A	
	FSK62-L/M8	10048112	可焊接最大 24AWG(0.25mm <sup>2</sup> )电缆 105°C 24V 1A	
M8x1 后端锁紧,PCB 孔座	FSBK52-P/M8	10048120	5XØ0.6mm 105°C 30V 3A	
	FSK62-P/M8	10048113	6xØ0.6mm 105°C 24V 1A	

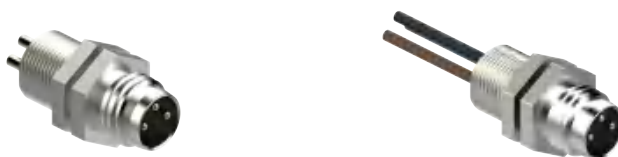

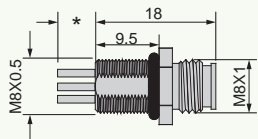
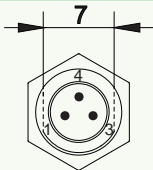
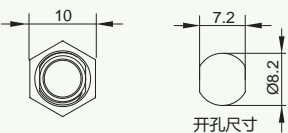
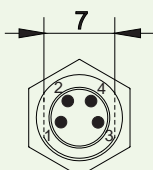
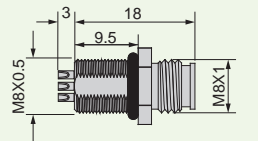
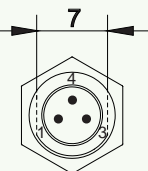
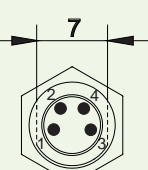
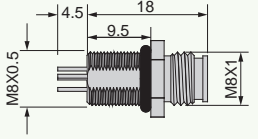
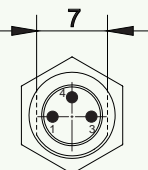
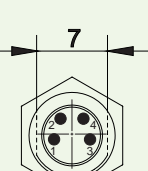
法兰连接器	型号	订货号	特性描述	针脚编号分布
M8x1 后端锁紧,出线 针座 	FSZ32-0.5/M8	10043100	3x24AWG(3x0.25mm <sup>2</sup> ) PVC 105°C 60V 4A	 1.BN 3.BU 4.BK
	FSZ32-1.0/M8	10043101		
 开孔尺寸	FSZ42-0.5/M8	10043110	4x24AWG(4x0.25mm <sup>2</sup> ) PVC 105°C 30V 4A	 1.BN 2.WH 3.BU 4.BK
	FSZ42-1.0/M8	10043111		
M8x1 后端锁紧,焊接 针座 	FSZ32-L/M8	10043119	可焊接最大22AWG (0.34mm <sup>2</sup> )电缆 105°C 60V 4A	 1.BN 3.BU 4.BK
	FSZ42-L/M8	10043120	可焊接最大22AWG (0.34mm <sup>2</sup> )电缆 105°C 30V 4A	 1.BN 2.WH 3.BU 4.BK
M8x1 后端锁紧,PCB 针座 	FSZ32-P/M8	10043102	3XØ0.6mm 105°C 60V 4A	 1.BN 3.BU 4.BK
	FSZ42-P/M8	10043127	4XØ0.6mm 105°C 30V 4A	 1.BN 2.WH 3.BU 4.BK

## 后端锁紧M8法兰连接器

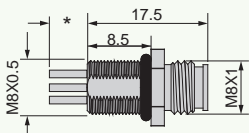
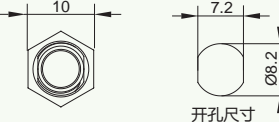
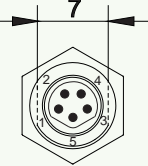
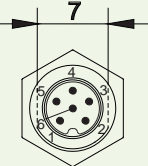
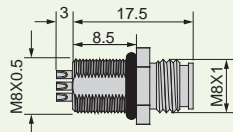
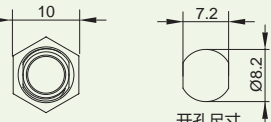
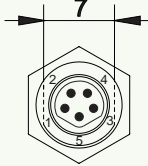
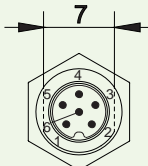
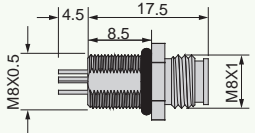
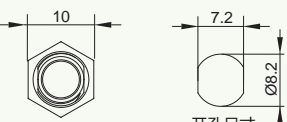
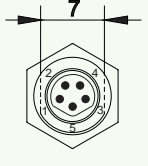
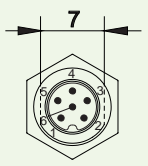

法兰连接器	型号	订货号	特性描述	针脚编号分布	
M8x1 后端锁紧,出线 针座    	FSBZ52-0.5/M8 FSBZ52-1.0/M8	10048121 10048122	5x22AWG(5x0.34mm <sup>2</sup> ) PVC 105°C 30V 3A		
	FSZ62-0.5/M8 FSZ62-1.0/M8	10048130 10048131	6x26AWG(6x0.14mm <sup>2</sup> ) PVC 105°C 24V 1A		
	M8x1 后端锁紧,焊接 针座    	FSBZ52-L/M8	10048123	可焊接最大 22AWG(0.34mm <sup>2</sup> )电缆 105°C 30V 3A	
		FSZ62-L/M8	10048132	可焊接最大 26AWG(0.14mm <sup>2</sup> )电缆 105°C 24V 1A	
M8x1 后端锁紧,PCB 针座    	FSBZ52-P/M8	10048124	5XØ0.6mm 105°C 30V 3A		
	FSZ62-P/M8	10048133	6XØ0.6mm 105°C 24V 1A		

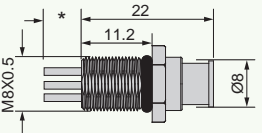
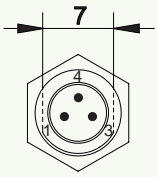
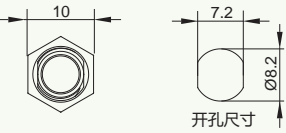
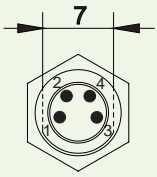
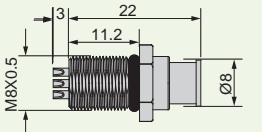
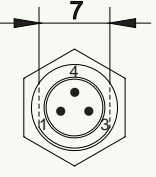
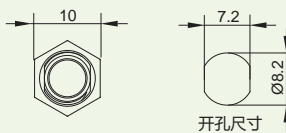
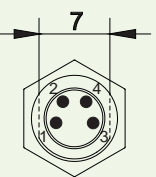

法兰连接器	型号	订货号	特性描述	针脚编号分布
Ø8x1 后端锁紧,出线 针座 	FRZ32-0.5/M8	10043133	3x24AWG(3x0.25mm <sup>2</sup> ) PVC 105°C 60V 4A	
	FRZ32-1.0/M8	10043134		
	FRZ42-0.5/M8	10043130	4x24AWG(4x0.25mm <sup>2</sup> ) PVC 105°C 30V 4A	
	FRZ42-1.0/M8	10043131		
Ø8x1 后端锁紧,焊接 针座 	FRZ32-L/M8	10043135	可焊接最大22AWG (0.34mm <sup>2</sup> )电缆 105°C 60V 4A	
	FRZ42-L/M8	10043136		
	FRZ32-P/M8	10043137	3XØ0.6mm 105°C 60V 4A	
	FRZ42-P/M8	10043138		

# 前端锁紧M8法兰连接器



法兰连接器	型号	订货号	特性描述	针脚编号分布
M8x1 前端锁紧,出线 针座 	FSZ31-0.5/M8	10043139	3x24AWG(3x0.25mm <sup>2</sup> ) PVC 105°C 60V 4A	<ul style="list-style-type: none"> <li>1.BN</li> <li>3.BU</li> <li>4.BK</li> </ul>
	FSZ31-1.0/M8	10043140		
	FSZ41-0.5/M8	10043141	4x24AWG(4x0.25mm <sup>2</sup> ) PVC 105°C 30V 4A	<ul style="list-style-type: none"> <li>1.BN</li> <li>2.WH</li> <li>3.BU</li> <li>4.BK</li> </ul>
	FSZ41-1.0/M8	10043142		
M8x1 前端锁紧,焊接 针座 	FSZ31-L/M8	10043143	可焊接最大 22AWG(0.34mm <sup>2</sup> )电缆 105°C 60V 4A	
	FSZ41-L/M8	10043123	可焊接最大 22AWG(0.34mm <sup>2</sup> )电缆 105°C 30V 4A	
M8x1 前端锁紧,PCB 针座 	FSZ31-P/M8	10043144	3XØ0.6mm 105°C 60V 4A	
	FSZ41-P/M8	10043124	4XØ0.6mm 105°C 30V 4A	

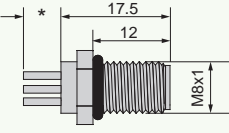
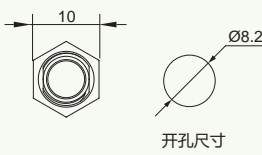
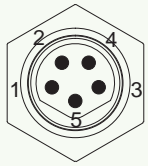
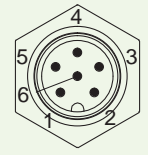
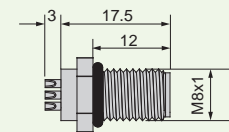
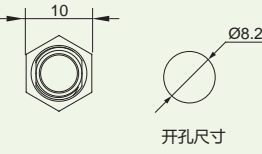
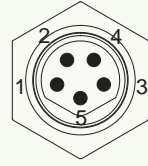
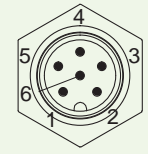
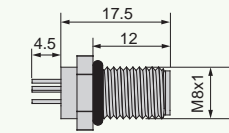
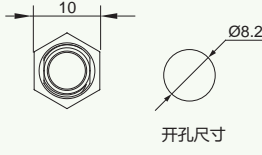
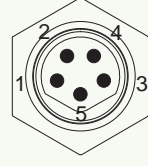
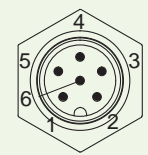

法兰连接器	型号	订货号	特性描述	针脚编号分布
M8x1 前端锁紧,出线 针座  	FSBZ51-0.5/M8 FSBZ51-1.0/M8	10043149 10048141	5x22AWG(5x0.34mm <sup>2</sup> ) PVC 105°C 30V 3A	 <ul style="list-style-type: none"> <li>1.BN</li> <li>2.WH</li> <li>3.BU</li> <li>4.BK</li> <li>5.GY</li> </ul>
	FSZ61-0.5/M8 FSZ61-1.0/M8	10048150 10048151	6x26AWG(6x0.14mm <sup>2</sup> ) PVC 105°C 24V 1A	 <ul style="list-style-type: none"> <li>1.BN</li> <li>2.WH</li> <li>3.BU</li> <li>4.BK</li> <li>5.GY</li> <li>6.PK</li> </ul>
M8x1 前端锁紧,焊接 针座  	FSBZ51-L/M8	10048116	可焊接最大 22AWG(0.34mm <sup>2</sup> )电缆 105°C 30V 3A	
	FSZ61-L/M8	10048152	可焊接最大 26AWG(0.14mm <sup>2</sup> )电缆 105°C 24V 1A	
M8x1 前端锁紧,PCB 针座  	FSBZ51-P/M8	10048143	5XØ0.6mm 105°C 30V 3A	
	FSZ61-P/M8	10048153	6XØ0.6mm 105°C 24V 1A	



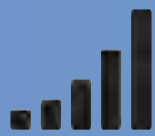

## ■ M12 工业连接器

# M12 连接器命名规则

## 预铸式连接器命名规则

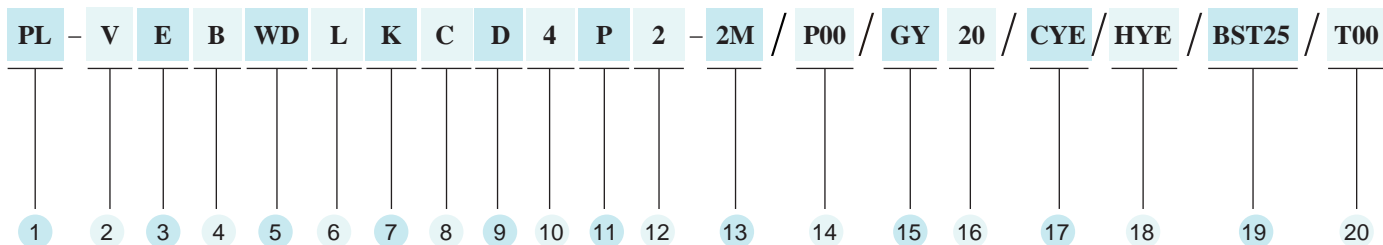

- |   |   |  |
|---|---|--|
| <p>1 M12电源系列连接器<br/>PT T-CODE<br/>PS S-CODE<br/>PL L-CODE<br/>PK K-CODE</p> <p>2 Blank 标准结构<br/>V 抗震止退结构 (升级)</p> <p>3 E M12X1连接器</p> <p>4 Blank A-code<br/>B B-code<br/>P Profibus<br/>I Ethernet、Profinet<br/>N DeviceNet<br/>Y Y-Code</p> <p>5 Blank 黄铜镀镍螺母<br/>WD 不锈钢螺母<br/>AF 塑料螺母</p> <p>6 Blank 直线型<br/>L 直角型</p> <p>7 K 孔座<br/>Z 针座</p> | <p>8 插针形式<br/>Blank 标准结构<br/>C 卷针</p> <p>9 Blank 标准结构<br/>D 短型结构(屏蔽或6针以上)</p> <p>10 针脚数<br/>编号分配</p> <p>11 LED指示(I/O连接器)<br/>P PNP<br/>N NPN</p> <p>12 指示灯数量(I/O连接器)</p> <p>13 电缆长度[m]</p> <p>14 电缆材质代码<br/>参考电缆型号说明</p> <p>15 电缆颜色<br/>Blank 标准色黑色<br/>GY 灰色<br/>OR 橙色<br/>YE 黄色</p> | <p>16 电缆线规<br/>Blank标准线规 2-5pin 22AWG<br/>6-12pin 24AWG<br/>20 20AWG<br/>18 18AWG</p> <p>17 针托颜色<br/>Blank 标准色黑色</p> <p>18 预铸接头颜色<br/>Blank 标准色黑色<br/>HGY 灰色预铸接头<br/>HYE 黄色预铸接头<br/>HBU 蓝色预铸接头<br/>HOR 橙色预铸接头<br/>HRD 红色预铸接头</p> <p>19 标识套(不带标记牌)<br/>双端插件默认两个, 单端默认一个<br/>Blank 标准不带标识套<br/>BST25 25mm长标识套</p> <p>20 特殊规格定制</p> |
|---|---|--|

### 双端预铸型号举例



EK5 EZ5-2M/P00



EK8 ELZ8-2M/P00



ELK5 EZ5-2M/S10



PL-ELK5 PL-ELZ5-2M/P00

## 法兰连接器命名规则

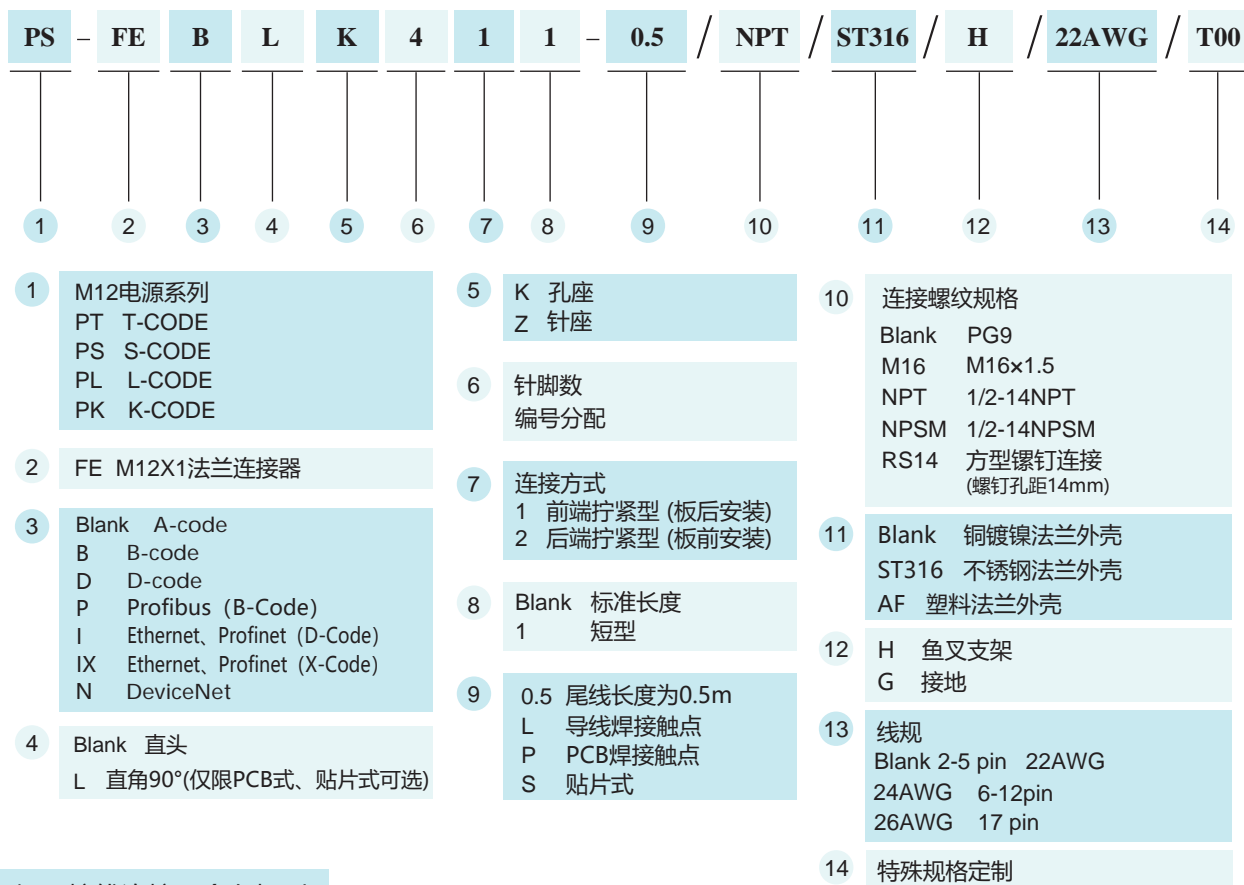

## 现场可接线连接器命名规则

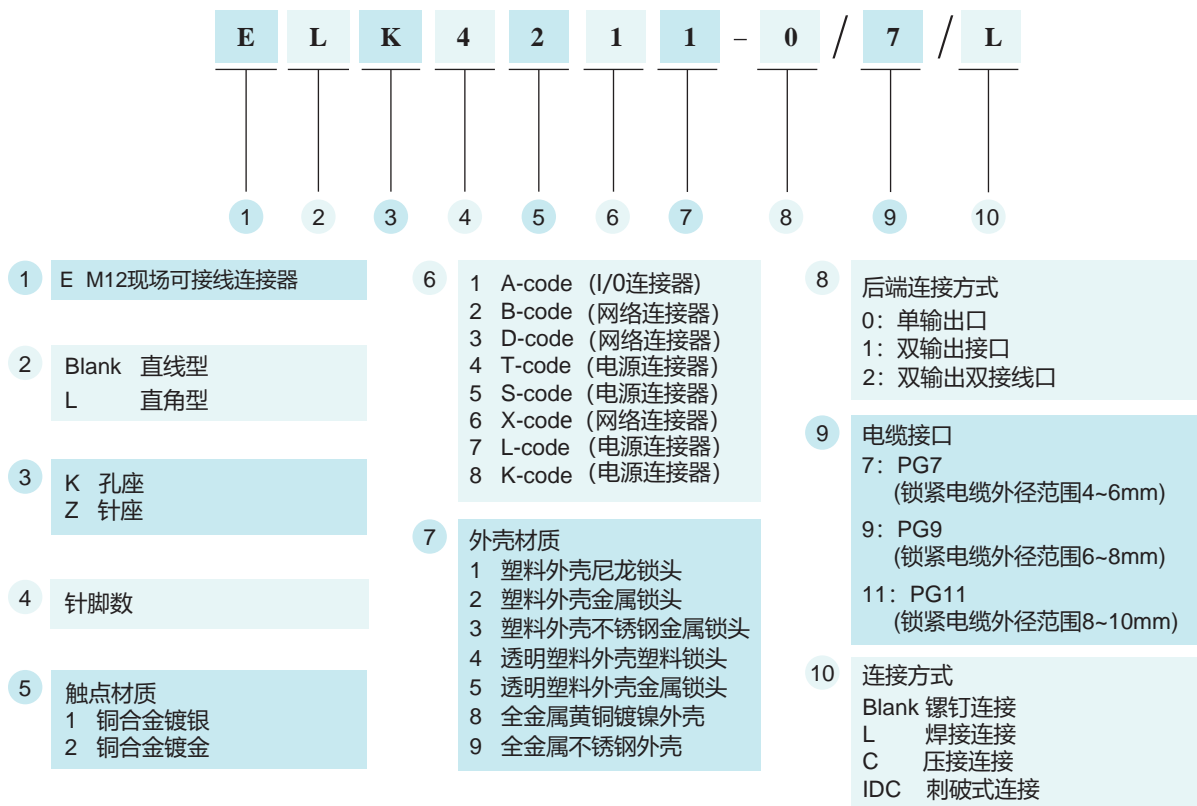

## 2针M12预铸式连接器

- 预铸接头:TPU材质,黑色
- 锁紧螺母:黄铜镀镍
- 针托:TPU材质,黑色
- 触点:黄铜镀金
- 密封圈:FPM/FKM
- 防护等级:IP67
- 电流等级:4A
- 电压等级:250V
- 绝缘电阻: $\geq 10^9 \Omega$
- 接触电阻: $\leq 5m\Omega$
- 污染等级:3
- 使用环境温度: $-40 \sim +80^\circ\text{C}$
- 可插拔寿命:最小100次
- 电缆最大外径:  
直头  $\leq 5.5\text{mm}$   
弯头  $\leq 6.0\text{mm}$



预铸式连接器	型号	订货号	电缆	针脚编号分布
直线孔座EK..** 	EK4.2-2M/P00 EK4.2-5M/P00 EK4.2-10M/P00	10019000 10016328 10110187	黑色PVC电缆 2x22AWG (2x0.34mm <sup>2</sup> ) Ø5.2mm 电缆型号: 58021151-*M	孔座 1.N/C 2.N/C 3.BN 4.BU
直角孔座ELK..** 	ELK4.2-2M/P00 ELK4.2-5M/P00 ELK4.2-10M/P00	10019020 10011708 10011928		
直线针座EZ..** 	EZ4.2-2M/P00 EZ4.2-5M/P00 EZ4.2-10M/P00	10019010 10019082 10110188	黑色PVC电缆 2x22AWG (2x0.34mm <sup>2</sup> ) Ø5.2mm 电缆型号: 58021151-*M	针座 1.N/C 2.N/C 3.BN 4.BU
直角针座ELZ..** 	ELZ4.2-2M/P00 ELZ4.2-5M/P00 ELZ4.2-10M/P00	10019030 10019113 10019114		
直线孔座EK..** (NAMUR) 	EK4.21-2M/P00 EK4.21-5M/P00 EK4.21-10M/P00	10016000 10110021 10019607	蓝色PVC电缆 2x22AWG (2x0.34mm <sup>2</sup> ) Ø5.2mm 电缆型号: 58016231-*M	孔座 1.BN 2.BU 3.N/C 4.N/C
直角孔座ELK..** (NAMUR) 	ELK4.21-2M/P00 ELK4.21-5M/P00 ELK4.21-10M/P00	10016010 10016002 10016028		
直线针座EZ..** (NAMUR) 	EZ4.21-2M/P00 EZ4.21-5M/P00 EZ4.21-10M/P00	10016020 10016003 10016004	蓝色PVC电缆 2x22AWG (2x0.34mm <sup>2</sup> ) Ø5.2mm 电缆型号: 58016231-*M	针座 1.BN 2.BU 3.N/C 4.N/C
直角针座ELZ..** (NAMUR) 	ELZ4.21-2M/P00 ELZ4.21-5M/P00 ELZ4.21-10M/P00	10016030 10016005 10016006		

\* 标准长度为2/5/10米,可订制任意长度

\*\* 标准锁紧螺母材质为黄铜镀镍

## 3针/4针M12预铸式连接器

- 预铸接头:TPU材质,黑色
- 锁紧螺母:黄铜镀镍
- 针托:TPU材质,黑色
- 触点:黄铜镀金
- 密封圈:FPM/FKM
- 防护等级:IP67
- 电流等级:4A
- 电压等级:250V
- 绝缘电阻: $\geq 10^9 \Omega$
- 接触电阻: $\leq 5m\Omega$
- 污染等级:3
- 使用环境温度: $-40 \sim +80^\circ\text{C}$
- 可插拔寿命:最小100次
- 电缆最大外径:  
直头  $\leq 5.5\text{mm}$   
弯头  $\leq 6.0\text{mm}$



预铸式连接器	型号	订货号	电缆	针脚编号分布
<b>直线孔座EK..**</b> 	EK3-2M/P00 EK3-5M/P00 EK3-10M/P00	10011000 10011001 10011002	黑色PVC电缆 3x22AWG (3x0.34mm <sup>2</sup> ) Ø5.2mm 电缆型号: 58005251-*M	<b>孔座</b>  1.BN 2.N/C 3.BU 4.BK
<b>直角孔座ELK..**</b> 	ELK3-2M/P00 ELK3-5M/P00 ELK3-10M/P00	10011030 10011031 10011032	黑色PVC电缆 3x22AWG (3x0.34mm <sup>2</sup> ) Ø5.2mm 电缆型号: 58005251-*M	<b>孔座</b>  1.BN 2.N/C 3.BU 4.BK
<b>直线针座EZ..**</b> 	EZ3-2M/P00 EZ3-5M/P00 EZ3-10M/P00	10011060 10011061 10011062	黑色PVC电缆 3x22AWG (3x0.34mm <sup>2</sup> ) Ø5.2mm 电缆型号: 58005251-*M	<b>针座</b>  1.BN 2.N/C 3.BU 4.BK
<b>直角针座ELZ..**</b> 	ELZ3-2M/P00 ELZ3-5M/P00 ELZ3-10M/P00	10011090 10011091 10011099	黑色PVC电缆 3x22AWG (3x0.34mm <sup>2</sup> ) Ø5.2mm 电缆型号: 58005251-*M	<b>针座</b>  1.BN 2.N/C 3.BU 4.BK
<b>直线孔座EK..**</b> 	EK4-2M/P00 EK4-5M/P00 EK4-10M/P00	10011010 10011011 10011012	黑色PVC电缆 4x22AWG (4x0.34mm <sup>2</sup> ) Ø5.2mm 电缆型号: 58015251-*M	<b>孔座</b>  1.BN 2.WH 3.BU 4.BK
<b>直角孔座ELK..**</b> 	ELK4-2M/P00 ELK4-5M/P00 ELK4-10M/P00	10011040 10011041 10011042	黑色PVC电缆 4x22AWG (4x0.34mm <sup>2</sup> ) Ø5.2mm 电缆型号: 58015251-*M	<b>孔座</b>  1.BN 2.WH 3.BU 4.BK
<b>直线针座EZ..**</b> 	EZ4-2M/P00 EZ4-5M/P00 EZ4-10M/P00	10011070 10011071 10011072	黑色PVC电缆 4x22AWG (4x0.34mm <sup>2</sup> ) Ø5.2mm 电缆型号: 58015251-*M	<b>针座</b>  1.BN 2.WH 3.BU 4.BK
<b>直角针座ELZ..**</b> 	ELZ4-2M/P00 ELZ4-5M/P00 ELZ4-10M/P00	10011100 10011765 10011102	黑色PVC电缆 4x22AWG (4x0.34mm <sup>2</sup> ) Ø5.2mm 电缆型号: 58015251-*M	<b>针座</b>  1.BN 2.WH 3.BU 4.BK

\* 标准长度为2/5/10米,可订制任意长度

\*\* 标准锁紧螺母材质为黄铜镀镍

## 4针/5针M12预铸式连接器

- 预铸接头:TPU材质,黑色
- 锁紧螺母:黄铜镀镍
- 针托:TPU材质,黑色
- 触点:黄铜镀金
- 密封圈:FPM/FKM
- 防护等级:IP67
- 电流等级:4A
- 电压等级:250V
- 绝缘电阻: $\geq 10^9 \Omega$
- 接触电阻: $\leq 5m\Omega$
- 污染等级:3
- 使用环境温度: $-40 \sim +80^\circ\text{C}$
- 可插拔寿命:最小100次
- 电缆最大外径:  
直头  $\leq 5.5\text{mm}$   
弯头  $\leq 6.0\text{mm}$



预铸式连接器	型号	订货号	电缆	针脚编号分布
直线孔座EK..** (NAMUR)	EK4.41-2M/P00 EK4.41-5M/P00 EK4.41-10M/P00	10016300 10016341 10016007	蓝色PVC电缆 4x22AWG (4x0.34mm <sup>2</sup> ) Ø5.2mm 电缆型号: 58019252-*M	孔座  1.BN 2.WH 3.BU 4.BK
直角孔座ELK..** (NAMUR)	ELK4.41-2M/P00 ELK4.41-5M/P00 ELK4.41-10M/P00	10016310 10016311 10016309		
直线针座EZ..** (NAMUR)	EZ4.41-2M/P00 EZ4.41-5M/P00 EZ4.41-10M/P00	10016320 10016008 10016009		针座  1.BN 2.WH 3.BU 4.BK
直角针座ELZ..** (NAMUR)	ELZ4.41-2M/P00 ELZ4.41-5M/P00 ELZ4.41-10M/P00	10016330 10110397 10110398	蓝色PVC电缆 4x22AWG (4x0.34mm <sup>2</sup> ) Ø5.2mm 电缆型号: 58019252-*M	针座  1.BN 2.WH 3.BU 4.BK
直线孔座EK..**	EK4.5-2M/P00 EK4.5-5M/P00 EK4.5-10M/P00	10011020 10011021 10011852	黑色PVC电缆 5x22AWG (5x0.34mm <sup>2</sup> ) Ø5.2mm 电缆型号: 58610231-*M	孔座  1.BN 2.WH 3.BU 4.BK 5.GY
直角孔座ELK..**	ELK4.5-2M/P00 ELK4.5-5M/P00 ELK4.5-10M/P00	10011050 10011427 10011052		
直线针座EZ..**	EZ4.5-2M/P00 EZ4.5-5M/P00 EZ4.5-10M/P00	10011080 10019027 10113010		针座  1.BN 2.WH 3.BU 4.BK 5.GY
直角针座ELZ..**	ELZ4.5-2M/P00 ELZ4.5-5M/P00 ELZ4.5-10M/P00	10011110 10113011 10113012	黑色PVC电缆 5x22AWG (5x0.34mm <sup>2</sup> ) Ø5.2mm 电缆型号: 58610231-*M	针座  1.BN 2.WH 3.BU 4.BK 5.GY

\* 标准长度为2/5/10米,可订制任意长度

\*\* 标准锁紧螺母材质为黄铜镀镍

## 5针/6针M12预铸式连接器

- 预铸接头:TPU材质,黑色
- 锁紧螺母:黄铜镀镍
- 针托:TPU材质,黑色
- 触点:黄铜镀金
- 密封圈:FPM/FKM
- 防护等级:IP67
- 电流等级:5芯4A 6芯2A
- 电压等级:5芯250V/6芯 60V
- 绝缘电阻: $\geq 10^9 \Omega$
- 接触电阻: $\leq 5m\Omega$
- 污染等级:3
- 使用环境温度: $-40 \sim +80^\circ\text{C}$
- 可插拔寿命:最小100次



预铸式连接器	型号	订货号	电缆	针脚编号分布
直线孔座EK..** 	EK5-2M/P00 EK5-5M/P00 EK5-10M/P00	10011500 10011501 10011502	黑色PVC电缆 4x22+1x20AWG (4x0.34+1x0.5mm <sup>2</sup> ) Ø5.2mm 电缆型号: 58078351-*M	孔座  1.BN 2.WH 3.BU 4.BK 5.GN/YE
直角孔座ELK..** 	ELK5-2M/P00 ELK5-5M/P00 ELK5-10M/P00	10011520 10110154 10011522	黑色PVC电缆 4x22+1x20AWG (4x0.34+1x0.5mm <sup>2</sup> ) Ø5.2mm 电缆型号: 58078351-*M	孔座  1.BN 2.WH 3.BU 4.BK 5.GN/YE
直线针座EZ..** 	EZ5-2M/P00 EZ5-5M/P00 EZ5-10M/P00	10011510 10016044 10113020	黑色PVC电缆 4x22+1x20AWG (4x0.34+1x0.5mm <sup>2</sup> ) Ø5.2mm 电缆型号: 58078351-*M	针座  1.BN 2.WH 3.BU 4.BK 5.GN/YE
直角针座ELZ..** 	ELZ5-2M/P00 ELZ5-5M/P00 ELZ5-10M/P00	10011530 10113021 10113022	黑色PVC电缆 4x22+1x20AWG (4x0.34+1x0.5mm <sup>2</sup> ) Ø5.2mm 电缆型号: 58078351-*M	针座  1.BN 2.WH 3.BU 4.BK 5.GN/YE
直线孔座EK..** 	EK6-2M/P00 EK6-5M/P00 EK6-10M/P00	10011600 10113030 10011602	黑色PVC电缆 6x24AWG (6x0.25mm <sup>2</sup> ) Ø5.6mm 电缆型号: 58029911-*M	孔座  1.BN 2.WH 3.BU 4.BK 5.GY 6.PK
直角孔座ELK..** 	ELK6-2M/P00 ELK6-5M/P00 ELK6-10M/P00	10011610 10113040 10113041	黑色PVC电缆 6x24AWG (6x0.25mm <sup>2</sup> ) Ø5.6mm 电缆型号: 58029911-*M	孔座  1.BN 2.WH 3.BU 4.BK 5.GY 6.PK
直线针座EZ..** 	EZ6-2M/P00 EZ6-5M/P00 EZ6-10M/P00	10011620 10113042 10113043	黑色PVC电缆 6x24AWG (6x0.25mm <sup>2</sup> ) Ø5.6mm 电缆型号: 58029911-*M	针座  1.BN 2.WH 3.BU 4.BK 5.GY 6.PK
直角针座ELZ..** 	ELZ6-2M/P00 ELZ6-5M/P00 ELZ6-10M/P00	10011630 10113044 10113045	黑色PVC电缆 6x24AWG (6x0.25mm <sup>2</sup> ) Ø5.6mm 电缆型号: 58029911-*M	针座  1.BN 2.WH 3.BU 4.BK 5.GY 6.PK

\* 标准长度为2/5/10米,可订制任意长度

\*\* 标准锁紧螺母材质为黄铜镀镍

## 8针/12针M12预铸式连接器

- 预铸接头:TPU材质,黑色
- 锁紧螺母:黄铜镀镍
- 针托:TPU材质,黑色
- 触点:黄铜镀金
- 密封圈:FPM/FKM
- 防护等级:IP67
- 电流等级:2A
- 电压等级:60V
- 绝缘电阻: $\geq 10^9 \Omega$
- 接触电阻: $\leq 5m\Omega$
- 污染等级:3
- 使用环境温度: $-40 \sim +80^\circ\text{C}$
- 可插拔寿命:最小100次
- 电缆最大外径: 9mm



预铸式连接器	型号	订货号	电缆	针脚编号分布
直线孔座EK..** 	EK8-2M/P00 EK8-5M/P00 EK8-10M/P00	10011800 10011801 10011802	黑色PVC电缆 8x24AWG (8x0.25mm <sup>2</sup> ) Ø6.2mm 电缆型号: 58045351-*M	孔座 
直角孔座ELK..** 	ELK8-2M/P00 ELK8-5M/P00 ELK8-10M/P00	10011810 10011811 10011812		针座 
直线针座EZ..** 	EZ8-2M/P00 EZ8-5M/P00 EZ8-10M/P00	10011820 10011829 10011822	黑色PVC电缆 8x24AWG (8x0.25mm <sup>2</sup> ) Ø6.2mm 电缆型号: 58045351-*M	孔座 
直角针座ELZ..** 	ELZ8-2M/P00 ELZ8-5M/P00 ELZ8-10M/P00	10011830 10016672 10016673		针座 
直线孔座EK..** 	EK12-2M/P00 EK12-5M/P00 EK12-10M/P00	10110318 10110399 10011902	黑色PVC电缆 12x24AWG (12x0.25mm <sup>2</sup> ) Ø7.3mm 电缆型号: 58127911-*M	孔座 
直角孔座ELK..** 	ELK12-2M/P00 ELK12-5M/P00 ELK12-10M/P00	10011910 10110189 10110197		针座 
直线针座EZ..** 	EZ12-2M/P00 EZ12-5M/P00 EZ12-10M/P00	10011920 10019048 10019249	黑色PVC电缆 12x24AWG (12x0.25mm <sup>2</sup> ) Ø7.3mm 电缆型号: 58127911-*M	孔座 
直角针座ELZ..** 	ELZ12-2M/P00 ELZ12-5M/P00 ELZ12-10M/P00	10011930 10019250 10019251		针座 

\* 标准长度为2/5/10米,可订制任意长度

\*\* 标准锁紧螺母材质为黄铜镀镍

## 17针M12预铸式连接器

- 预铸接头:TPU材质,黑色
- 锁紧螺母:黄铜镀镍
- 针托:TPU材质,黑色
- 触点:黄铜镀金
- 密封圈:FPM/FKM
- 防护等级:IP67
- 电流等级:1.5A
- 电压等级:30V
- 绝缘电阻: $\geq 100M\Omega$
- 接触电阻: $\leq 5m\Omega$
- 污染等级:3
- 使用环境温度: $-40\sim+80^{\circ}C$
- 可插拔寿命:最小100次
- 电缆最大外径: 9mm



预铸式连接器	型号	订货号	电缆	针脚编号分布
<p>直线孔座EK..**</p>	EK17-2M/P00 EK17-5M/P00 EK17-10M/P00	10250720 10250721 10250722	黑色PVC电缆 17x26AWG (17x0.14mm <sup>2</sup> ) Ø6.4mm 电缆型号: 58074911-*M	<p>孔座</p> <p>1.BN 2.BU 3.WH 4.GN 5.PK 6.YE 7.BK 8.GY 9.RD 10.VT 11.GY/PK 12.RD/BU 13.WH/GN 14.BN/GN 15.WH/YE 16.YE/BN 17.WH/GY</p>
<p>直角孔座ELK..**</p>	ELK17-2M/P00 ELK17-5M/P00 ELK17-10M/P00	10250723 10250724 10250725		<p>针座</p> <p>1.BN 2.BU 3.WH 4.GN 5.PK 6.YE 7.BK 8.GY 9.RD 10.VT 11.GY/PK 12.RD/BU 13.WH/GN 14.BN/GN 15.WH/YE 16.YE/BN 17.WH/GY</p>
<p>直线针座EZ..**</p>	EZ17-2M/P00 EZ17-5M/P00 EZ17-10M/P00	10250657 10250730 10250731		<p>针座</p> <p>1.BN 2.BU 3.WH 4.GN 5.PK 6.YE 7.BK 8.GY 9.RD 10.VT 11.GY/PK 12.RD/BU 13.WH/GN 14.BN/GN 15.WH/YE 16.YE/BN 17.WH/GY</p>
<p>直角针座ELZ..**</p>	ELZ17-2M/P00 ELZ17-5M/P00 ELZ17-10M/P00	10250732 10250733 10250734		<p>针座</p> <p>1.BN 2.BU 3.WH 4.GN 5.PK 6.YE 7.BK 8.GY 9.RD 10.VT 11.GY/PK 12.RD/BU 13.WH/GN 14.BN/GN 15.WH/YE 16.YE/BN 17.WH/GY</p>

\* 标准长度为2/5/10米,可订制任意长度

\*\* 标准锁紧螺母材质为黄铜镀镍

## 3针/4针M12全屏蔽型预铸式连接器

- 预铸接头:TPU材质,黑色
- 锁紧螺母:黄铜镀镍
- 针托:TPU材质,黑色
- 触点:黄铜镀金
- 密封圈:FPM/FKM
- 防护等级:IP67
- 电流等级:4A
- 电压等级:250V
- 绝缘电阻: $\geq 10^9 \Omega$
- 接触电阻: $\leq 5m\Omega$
- 污染等级:3
- 使用环境温度: $-40 \sim +80^\circ C$
- 可插拔寿命:最小100次
- 电缆最大外径: 9mm



预铸式连接器	型号	订货号	电缆	针脚编号分布
直线孔座EK..** 	EK3-2M/S10 EK3-5M/S10 EK3-10M/S10	10011300 10011301 10016041	黑色屏蔽PVC电缆 3x22AWG (3x0.34mm <sup>2</sup> ) Ø5.2mm 电缆型号: 58008351-*M	孔座 
直角孔座ELK..** 	ELK3-2M/S10 ELK3-5M/S10 ELK3-10M/S10	10011320 10011764 10011763		1.BN 2.N/C 3.BU 4.BK
直线针座EZ..** 	EZ3-2M/S10 EZ3-5M/S10 EZ3-10M/S10	10011340 10016051 10016052	黑色屏蔽PVC电缆 3x22AWG (3x0.34mm <sup>2</sup> ) Ø5.2mm 电缆型号: 58008351-*M	针座 
直角针座ELZ..** 	ELZ3-2M/S10 ELZ3-5M/S10 ELZ3-10M/S10	10011360 10016053 10016054		1.BN 2.N/C 3.BU 4.BK
直线孔座EK..** 	EK4-2M/S10 EK4-5M/S10 EK4-10M/S10	10011310 10016013 10016001	黑色屏蔽PVC电缆 4x22AWG (4x0.34mm <sup>2</sup> ) Ø5.2mm 电缆型号: 58016911-*M	孔座 
直角孔座ELK..** 	ELK4-2M/S10 ELK4-5M/S10 ELK4-10M/S10	10011330 10011331 10011332		1.BN 2.WH 3.BU 4.BK
直线针座EZ..** 	EZ4-2M/S10 EZ4-5M/S10 EZ4-10M/S10	10011350 10016055 10012177	黑色屏蔽PVC电缆 4x22AWG (4x0.34mm <sup>2</sup> ) Ø5.2mm 电缆型号: 58016911-*M	针座 
直角针座ELZ..** 	ELZ4-2M/S10 ELZ4-5M/S10 ELZ4-10M/S10	10011370 10016056 10016057		1.BN 2.WH 3.BU 4.BK

\* 标准长度为2/5/10米,可订制任意长度

\*\* 标准锁紧螺母材质为黄铜镀镍

## 5针/6针M12全屏蔽型预铸式连接器

- 预铸接头:TPU材质,黑色
- 锁紧螺母:黄铜镀镍
- 针托:TPU材质,黑色
- 触点:黄铜镀金
- 密封圈:FPM/FKM
- 防护等级:IP67
- 电流等级:4A
- 电压等级:5芯250V 6芯 60V
- 绝缘电阻: $\geq 10^9 \Omega$
- 接触电阻: $\leq 5m\Omega$
- 污染等级:3
- 使用环境温度:-40~+80°C
- 可插拔寿命:最小100次
- 电缆最大外径: 9mm



预铸式连接器	型号	订货号	电缆	针脚编号分布
直线孔座EK..** 	EK4.5-2M/S10 EK4.5-5M/S10 EK4.5-10M/S10	10011315 10110297 10110298	黑色屏蔽PVC电缆 5x22AWG (5x0.34mm <sup>2</sup> ) Ø5.2mm 电缆型号: 58028351-*M	孔座 1.BN 2.WH 3.BU 4.BK 5.GY
直角孔座ELK..** 	ELK4.5-2M/S10 ELK4.5-5M/S10 ELK4.5-10M/S10	10011345 10110299 10016058		针座 1.BN 2.WH 3.BU 4.BK 5.GY
直线针座EZ..** 	EZ4.5-2M/S10 EZ4.5-5M/S10 EZ4.5-10M/S10	10011355 10019028 10016059	黑色屏蔽PVC电缆 5x22AWG (5x0.34mm <sup>2</sup> ) Ø5.2mm 电缆型号: 58028351-*M	孔座 1.BN 2.WH 3.BU 4.BK 5.GY 6.PK
直角针座ELZ..** 	ELZ4.5-2M/S10 ELZ4.5-5M/S10 ELZ4.5-10M/S10	10016061 10016062 10016063		针座 1.BN 2.WH 3.BU 4.BK 5.GY 6.PK
直线孔座EK..** 	EK6-2M/S10 EK6-5M/S10 EK6-10M/S10	10016600 10113050 10113051	黑色屏蔽PVC电缆 6x24AWG (6x0.25mm <sup>2</sup> ) Ø5.6mm 电缆型号: 58061351-*M	针座 1.BN 2.WH 3.BU 4.BK 5.GY 6.PK
直角孔座ELK..** 	ELK6-2M/S10 ELK6-5M/S10 ELK6-10M/S10	10016620 10113052 10113053		针座 1.BN 2.WH 3.BU 4.BK 5.GY 6.PK
直线针座EZ..** 	EZ6-2M/S10 EZ6-5M/S10 EZ6-10M/S10	10016610 10113054 10113055	黑色屏蔽PVC电缆 6x24AWG (6x0.25mm <sup>2</sup> ) Ø5.6mm 电缆型号: 58061351-*M	针座 1.BN 2.WH 3.BU 4.BK 5.GY 6.PK
直角针座ELZ..** 	ELZ6-2M/S10 ELZ6-5M/S10 ELZ6-10M/S10	10016630 10113056 10113057		针座 1.BN 2.WH 3.BU 4.BK 5.GY 6.PK

\* 标准长度为2/5/10米,可订制任意长度

\*\* 标准锁紧螺母材质为黄铜镀镍

# 8针/12针M12全屏蔽型预铸式连接器

- 预铸接头:TPU材质,黑色
- 锁紧螺母:黄铜镀镍
- 针托:TPU材质,黑色
- 触点:黄铜镀金
- 密封圈:FPM/FKM
- 防护等级:IP67
- 电流等级:2A
- 电压等级:60V
- 绝缘电阻: $\geq 10^9 \Omega$
- 接触电阻: $\leq 5m\Omega$
- 污染等级:3
- 使用环境温度:-40~+80°C
- 可插拔寿命:最小100次
- 电缆最大外径: 9mm



预铸式连接器	型号	订货号	电缆	针脚编号分布
<b>直线孔座EK..**</b> 	EK8-2M/S10 EK8-5M/S10 EK8-10M/S10	10016640 10110290 10011803	黑色屏蔽PVC电缆 8x24AWG (8x0.25mm <sup>2</sup> ) Ø6.2mm 电缆型号: 58093351-*M	<b>孔座</b> 
<b>直角孔座ELK..**</b> 	ELK8-2M/S10 ELK8-5M/S10 ELK8-10M/S10	10016660 10110291 10011971		<b>针座</b> 
<b>直线针座EZ..**</b> 	EZ8-2M/S10 EZ8-5M/S10 EZ8-10M/S10	10016650 10011821 10011847		<b>孔座</b> 
<b>直角针座ELZ..**</b> 	ELZ8-2M/S10 ELZ8-5M/S10 ELZ8-10M/S10	10016670 10016674 10016675		<b>针座</b> 
<b>直线孔座EK..**</b> 	EK12-2M/S10 EK12-5M/S10 EK12-10M/S10	10110315 10110316 10011901	黑色屏蔽PVC电缆 12x24AWG (12x0.25mm <sup>2</sup> ) Ø7.3mm 电缆型号: 58601351-*M	<b>孔座</b> 
<b>直角孔座ELK..**</b> 	ELK12-2M/S10 ELK12-5M/S10 ELK12-10M/S10	10016369 10011911 10011936		<b>针座</b> 
<b>直线针座EZ..**</b> 	EZ12-2M/S10 EZ12-5M/S10 EZ12-10M/S10	10019056 10019062 10019033		<b>孔座</b> 
<b>直角针座ELZ..**</b> 	ELZ12-2M/S10 ELZ12-5M/S10 ELZ12-10M/S10	10019011 10019012 10019013		<b>针座</b> 

\* 标准长度为2/5/10米,可订制任意长度

\*\* 标准锁紧螺母材质为黄铜镀镍

# 17针M12全屏蔽型预铸式连接器

- 预铸接头:TPU材质,黑色
- 锁紧螺母:黄铜镀镍
- 针托:TPU材质,黑色
- 触点:黄铜镀金
- 密封圈:FPM/FKM
- 防护等级:IP67
- 电流等级:1.5A
- 电压等级:30V
- 绝缘电阻: $\geq 100M\Omega$
- 接触电阻: $\leq 5m\Omega$
- 污染等级:3
- 使用环境温度: $-40\sim+80^{\circ}C$
- 可插拔寿命:最小100次
- 电缆最大外径: 9mm



预铸式连接器	型号	订货号	电缆	针脚编号分布
<b>直线孔座EK..**</b> 	EK17-2M/S10 EK17-5M/S10 EK17-10M/S10	10113076 10250721 10250722	黑色PVC电缆 17x26AWG (17x0.14mm <sup>2</sup> ) Ø6.4mm 电缆型号: 58074911-*M	<b>孔座</b> 
<b>直角孔座ELK..**</b> 	ELK17-2M/S10 ELK17-5M/S10 ELK17-10M/S10	10250723 10250724 10250725		<b>针座</b> 
<b>直线针座EZ..**</b> 	EZ17-2M/S10 EZ17-5M/S10 EZ17-10M/S10	10250657 10250730 10250731		<b>针座</b> 
<b>直角针座ELZ..**</b> 	ELZ17-2M/S10 ELZ17-5M/S10 ELZ17-10M/S10	10250732 10250733 10250734		<b>针座</b> 

\* 标准长度为2/5/10米,可订制任意长度

\*\* 标准锁紧螺母材质为黄铜镀镍

## 3针/4针M12不锈钢预铸式连接器

- 预铸接头:TPU材质,黑色
- 锁紧螺母:不锈钢
- 针托:TPU材质,黑色
- 触点:黄铜镀金
- 密封圈:FPM/FKM
- 防护等级:IP67
- 电流等级:4A
- 电压等级:250V
- 绝缘电阻: $\geq 10^9 \Omega$
- 接触电阻: $\leq 5m\Omega$
- 污染等级:3
- 使用环境温度: $-40 \sim +80^\circ C$
- 可插拔寿命:最小100次
- 电缆最大外径:  
直头  $\leq 5.5mm$   
弯头  $\leq 6.0mm$



预铸式连接器	型号	订货号	电缆	针脚编号分布
直线孔座EWDK..** 	EWDK3-2M/P00 EWDK3-5M/P00 EWDK3-10M/P00	10016852 10016853 10016851	黑色PVC电缆 3x22AWG (3x0.34mm <sup>2</sup> ) Ø5.2mm 电缆型号: 58005912-*M	孔座 1.BN 2.N/C 3.BU 4.BK
直角孔座EWDLK..** 	EWDLK3-2M/P00 EWDLK3-5M/P00 EWDLK3-10M/P00	10016856 10016857 10016855		
直线针座EWDZ..** 	EWDZ3-2M/P00 EWDZ3-5M/P00 EWDZ3-10M/P00	10016873 10016874 10016850	黑色PVC电缆 3x22AWG (3x0.34mm <sup>2</sup> ) Ø5.2mm 电缆型号: 58005912-*M	针座 1.BN 2.N/C 3.BU 4.BK
直角针座EWDLZ..** 	EWDLZ3-2M/P00 EWDLZ3-5M/P00 EWDLZ3-10M/P00	10016871 10016872 10016870		
直线孔座EWDK..** 	EWDK4-2M/P00 EWDK4-5M/P00 EWDK4-10M/P00	10110002 10016854 10255126	黑色PVC电缆 4x22AWG (4x0.34mm <sup>2</sup> ) Ø5.2mm 电缆型号: 58015251-*M	孔座 1.BN 2.WH 3.BU 4.BK
直角孔座EWDLK..** 	EWDLK4-2M/P00 EWDLK4-5M/P00 EWDLK4-10M/P00	10024075 10016861 10016860		
直线针座EWDZ..** 	EWDZ4-2M/P00 EWDZ4-5M/P00 EWDZ4-10M/P00	10016884 10016885 10016883	黑色PVC电缆 4x22AWG (4x0.34mm <sup>2</sup> ) Ø5.2mm 电缆型号: 58015251-*M	针座 1.BN 2.WH 3.BU 4.BK
直角针座EWDLZ..** 	EWDLZ4-2M/P00 EWDLZ4-5M/P00 EWDLZ4-10M/P00	10016881 10016882 10016880		

\* 标准长度为2/5/10米,可订制任意长度

\*\* 标准锁紧螺母材质为黄铜镀镍

## 3针/4针/5针M12带LED显示预铸式连接器

- |  |  |
|--|--|
| <ul style="list-style-type: none"> <li>■ 预铸接头:TPU材质,透明</li> <li>■ 锁紧螺母:黄铜镀镍</li> <li>■ 针托:TPU材质,黑色</li> <li>■ 触点:黄铜镀金</li> <li>■ 密封圈:FPM/FKM</li> <li>■ 防护等级:IP67</li> <li>■ 电流等级:4A</li> <li>■ 电压等级:10-30VDC</li> </ul> | <ul style="list-style-type: none"> <li>■ 绝缘电阻:<math>\geq 10^9 \Omega</math></li> <li>■ 正向电阻:<math>\leq 5m\Omega</math></li> <li>■ 污染等级:3</li> <li>■ 使用环境温度:-40~+80°C</li> <li>■ 可插拔寿命:最小100次</li> <li>■ 电缆最大外径:<br/>直头 <math>\leq 5.5mm</math><br/>弯头 <math>\leq 6.0mm</math></li> </ul> |
|--|--|



连接器类型	型号	订货号	电缆	针脚编号分布
直线孔座EK..** 	EK3P2-2M/P00	10016700	黑色PVC电缆 3x22AWG (3x0.34mm <sup>2</sup> ) Ø5.2mm 电缆型号: 58005912-*M	
	EK3P2-5M/P00	10016705		
	EK3P2-10M/P00	10016744		
直角孔座ELK..** 	ELK3P2-2M/P00	10011485	黑色PVC电缆 4x22AWG (4x0.34mm <sup>2</sup> ) Ø5.2mm 电缆型号: 58015251-*M	
	ELK3P2-5M/P00	10011486		
	ELK3P2-10M/P00	10016828		
直线孔座EK..** 	EK4P3-2M/P00	10016730	黑色PVC电缆 4x22AWG (4x0.34mm <sup>2</sup> ) Ø5.2mm 电缆型号: 58015251-*M	
	EK4P3-5M/P00	10016820		
	EK4P3-10M/P00	10016821		
直角孔座ELK..** 	ELK4P2-2M/P00	10016740	黑色PVC电缆 4x22AWG (4x0.34mm <sup>2</sup> ) Ø5.2mm 电缆型号: 58015251-*M	
	ELK4P2-5M/P00	10011496		
	ELK4P2-10M/P00	10016751		
直角孔座ELK..** 	ELK4P3-2M/P00	10016750	黑色PVC电缆 4x22+ 1x20AWG Ø5.2mm (4x0.34 + 1x0.5mm <sup>2</sup> ) 电缆型号: 58078351-*M	
	ELK4P3-5M/P00	10111531		
	ELK4P3-10M/P00	10016822		
直角孔座ELK..** 	ELK5P3-2M/P00	10016770	黑色PVC电缆 4x22+ 1x20AWG Ø5.2mm (4x0.34 + 1x0.5mm <sup>2</sup> ) 电缆型号: 58078351-*M	
	ELK5P3-5M/P00	10016825		
	ELK5P3-10M/P00	10016826		
直角孔座ELK..** 	ELK5P3.1-2M/P00	10016780	黑色PVC电缆 4x22+ 1x20AWG Ø5.2mm (4x0.34 + 1x0.5mm <sup>2</sup> ) 电缆型号: 58078351-*M	
	ELK5P3.1-5M/P00	10112561		
	ELK5P3.1-10M/P00	10016827		

\* 标准长度为2/5/10米,可订制任意长度

\*\* 标准锁紧螺母材质为黄铜镀镍

## 4针M12抗震止退预铸式连接器

- 预铸接头:TPU材质,蓝色
- 锁紧螺母:黄铜镀镍
- 针托:TPU材质,黑色
- 触点:黄铜镀金
- 密封圈:FPM/FKM
- 防护等级:IP67
- 电流等级:4A
- 电压等级:250V
- 绝缘电阻: $\geq 10^9 \Omega$
- 接触电阻: $\leq 5m\Omega$
- 污染等级:3
- 使用环境温度: $-40 \sim +75^\circ\text{C}$
- 可插拔寿命:最小100次
- 电缆最大外径:  
直头  $\leq 5.5\text{mm}$   
弯头  $\leq 6.0\text{mm}$



预铸式连接器	型号	订货号	电缆	针脚编号分布
直线孔座VEK..** 	VEK4-2M/P00 VEK4-5M/P00 VEK4-10M/P00	10022172 10027302 10022197	黑色PVC电缆 4x22AWG (4x0.34mm <sup>2</sup> ) Ø5.2mm 电缆型号: 58015251	孔座 1.BN 2.WH 3.BU 4.BK
直角孔座VELK..** 	VELK4-2M/P00 VELK4-5M/P00 VELK4-10M/P00	10022347 10022346 10022348		
直线针座VEZ..** 	VEZ4-2M/P00 VEZ4-5M/P00 VEZ4-10M/P00	10095590 10027175 10027173	黑色PVC电缆 4x22AWG (4x0.34mm <sup>2</sup> ) Ø5.2mm 电缆型号: 58015251	针座 1.BN 2.WH 3.BU 4.BK
直角孔座VELZ..** 	VELZ4-2M/P00 VELZ4-5M/P00 VELZ4-10M/P00	10011111 10011112 10022341		

\* 标准长度为2/5/10米,可订制任意长度

\*\* 标准锁紧螺母材质为黄铜镀镍

- 预铸接头:TPU材质,黑色
- 锁紧螺母:黄铜镀镍
- 针托:TPU材质,黑色
- 触点:黄铜镀金
- 密封圈:FPM/FKM
- 防护等级:IP67
- 电流等级:4A
- 电压等级:250V
- 绝缘电阻: $\geq 10^9 \Omega$
- 接触电阻: $\leq 5m\Omega$
- 污染等级:3
- 使用环境温度:  
固定安装:-50~+80°C  
移动安装:-25~+80°C
- 可插拔寿命:最小100次
- 电缆最大外径:  
直头  $\leq 5.5mm$   
弯头  $\leq 6.0mm$



预铸式连接器	型号	订货号	电缆	针脚编号分布
<b>直线孔座EK..**</b> 	EK3-2M/GSC EK3-5M/GSC EK3-10M/GSC	10023053 10115184 10110234	黑色PUR电缆 3x22AWG (3x0.34mm <sup>2</sup> ) Ø4.6mm	孔座 
<b>直角孔座ELK..**</b> 	ELK3-2M/GSC ELK3-5M/GSC ELK3-10M/GSC	10110680 10110682 10023312	不含卤素、硅、PVC和LABS 适合拖链, 折弯寿命大于500万次, 阻燃, 防飞溅, 抗磨损 cULus 认证, 符合RoHS	
<b>直线针座EZ..**</b> 	EZ3-2M/GSC EZ3-5M/GSC EZ3-10M/GSC	10110227 10110576 10110570	黑色PUR电缆 3x22AWG (3x0.34mm <sup>2</sup> ) Ø4.6mm	针座 
<b>直角针座ELZ..**</b> 	ELZ3-2M/GSC ELZ3-5M/GSC ELZ3-10M/GSC	10256207 10256208 10256209	不含卤素、硅、PVC和LABS 适合拖链, 折弯寿命大于500万次, 阻燃, 防飞溅, 抗磨损 cULus 认证, 符合RoHS	
<b>直线孔座EK..**</b> 	EK4-2M/GSC EK4-5M/GSC EK4-10M/GSC	10110191 10110163 10110193	黑色PUR电缆 4x22AWG (4x0.34mm <sup>2</sup> ) Ø4.6mm	孔座 
<b>直角孔座ELK..**</b> 	ELK4-2M/GSC ELK4-5M/GSC ELK4-10M/GSC	10016561 10016518 10016517	不含卤素、硅、PVC和LABS 适合拖链, 折弯寿命大于500万次, 阻燃, 防飞溅, 抗磨损 cULus 认证, 符合RoHS	
<b>直线针座EZ..**</b> 	EZ4-2M/GSC EZ4-5M/GSC EZ4-10M/GSC	10110228 10250794 10250795	黑色PUR电缆 4x22AWG (4x0.34mm <sup>2</sup> ) Ø4.6mm	针座 
<b>直角针座ELZ..**</b> 	ELZ4-2M/GSC ELZ4-5M/GSC ELZ4-10M/GSC	10019117 10023388 10019686	不含卤素、硅、PVC和LABS 适合拖链, 折弯寿命大于500万次, 阻燃, 防飞溅, 抗磨损 cULus 认证, 符合RoHS	

\* 标准长度为2/5/10米,可订制任意长度

\*\* 标准锁紧螺母材质为黄铜镀镍

# 4针/5针M12预铸式连接器

- 预铸接头:TPU材质,黑色
- 锁紧螺母:黄铜镀镍
- 针托:TPU材质,黑色
- 触点:黄铜镀金
- 密封圈:FPM/FKM
- 防护等级:IP67
- 电流等级:4A
- 电压等级:250V
- 绝缘电阻: $\geq 10^9 \Omega$
- 接触电阻: $\leq 5m\Omega$
- 污染等级:3
- 使用环境温度:  
固定安装:-50~+80°C  
移动安装:-25~+80°C
- 可插拔寿命:最小100次
- 电缆最大外径:  
直头  $\leq 5.5mm$   
弯头  $\leq 6.0mm$



预铸式连接器	型号	订货号	电缆	针脚编号分布
直线孔座EK..** 	EK4.5-2M/GSC EK4.5-5M/GSC EK4.5-10M/GSC	10110753 10110761 10110749	黑色PUR电缆 5x22AWG (5x0.34mm <sup>2</sup> ) Ø5.2mm 电缆型号: 58020231-*M	孔座 
直角孔座ELK..** 	ELK4.5-2M/GSC ELK4.5-5M/GSC ELK4.5-10M/GSC	10019629 10115471 10115478		针座 
直线针座EZ..** 	EZ4.5-2M/GSC EZ4.5-5M/GSC EZ4.5-10M/GSC	10130363 10011096 10011098	黑色PUR电缆 5x22AWG (5x0.34mm <sup>2</sup> ) Ø5.2mm 电缆型号: 58020231-*M	孔座 
直角针座ELZ..** 	ELZ4.5-2M/GSC ELZ4.5-5M/GSC ELZ4.5-10M/GSC	10011099 10110666 10130474		针座 
直线孔座EK..** 	EK5-2M/GSC EK5-5M/GSC EK5-10M/GSC	10110400 10110166 10110413	黑色PUR电缆 5x22AWG (5x0.34mm <sup>2</sup> ) Ø5.2mm 电缆型号: 58020311-*M	孔座 
直角孔座ELK..** 	ELK5-2M/GSC ELK5-5M/GSC ELK5-10M/GSC	10110402 10019763 10020830		针座 
直线针座EZ..** 	EZ5-2M/GSC EZ5-5M/GSC EZ5-10M/GSC	10110401 10251112 10255916	黑色PUR电缆 5x22AWG (5x0.34mm <sup>2</sup> ) Ø5.2mm 电缆型号: 58020311-*M	孔座 
直角针座ELZ..** 	ELZ5-2M/GSC ELZ5-5M/GSC ELZ5-10M/GSC	10110403 10011106 10011108		针座 

\* 标准长度为2/5/10米,可订制任意长度

\*\* 标准锁紧螺母材质为黄铜镀镍

## M12电源系列预铸式连接器T-CODE

- 预铸接头:TPU材质,黑色
- 锁紧螺母:黄铜镀镍
- 针托:TPU材质,黑色
- 触点:黄铜镀金
- 密封圈:FPM/FKM
- 防护等级:IP67
- 电流等级:12A
- 电压等级:63VDC
- 绝缘电阻: $\geq 10^9 \Omega$
- 接触电阻: $\leq 5m\Omega$
- 污染等级:3
- 使用环境温度: $-40 \sim +80^\circ\text{C}$
- 可插拔寿命:最小100次
- 电缆最大外径: 9mm



预铸式连接器	型号	订货号	电缆	针脚编号分布
直线孔座.** 	PT-EK4-2M/P00 PT-EK4-5M/P00 PT-EK4-10M/P00	10093095 10093096 10093097	黑色PVC电缆 4x16AWG (4x1.5mm <sup>2</sup> ) Ø8.5mm 电缆型号: 58011151-*M	4 孔座 
直角孔座.** 	PT-ELK4-2M/P00 PT-ELK4-5M/P00 PT-ELK4-10M/P00	10093098 10093099 10093100		1.BN 2.WH 3.BU 4.BK
直线针座.** 	PT-EZ4-2M/P00 PT-EZ4-5M/P00 PT-EZ4-10M/P00	10093101 10093102 10093103	黑色PVC电缆 4x16AWG (4x1.5mm <sup>2</sup> ) Ø8.5mm 电缆型号: 58011151-*M	4 针座 
直角针座.** 	PT-ELZ4-2M/P00 PT-ELZ4-5M/P00 PT-ELZ4-10M/P00	10093104 10093105 10093106		1.BN 2.WH 3.BU 4.BK
直线孔座.** 	PT-EK4-2M/S10 PT-EK4-5M/S10 PT-EK4-10M/S10	10093107 10093108 10093109	黑色屏蔽PVC电缆 4x16AWG (4x1.5mm <sup>2</sup> ) Ø8.5mm 电缆型号: 58016151-*M	4 孔座 
直角孔座.** 	PT-ELK4-2M/S10 PT-ELK4-5M/S10 PT-ELK4-10M/S10	10093110 10021388 10021389		1.BN 2.WH 3.BU 4.BK
直线针座.** 	PT-EZ4-2M/S10 PT-EZ4-5M/S10 PT-EZ4-10M/S10	10021390 10021391 10093115	黑色屏蔽PVC电缆 4x16AWG (4x1.5mm <sup>2</sup> ) Ø8.5mm 电缆型号: 58016151-*M	4 针座 
直角针座.** 	PT-ELZ4-2M/S10 PT-ELZ4-5M/S10 PT-ELZ4-10M/S10	10093116 10093117 10093118		1.BN 2.WH 3.BU 4.BK

\* 标准长度为2/5/10米,可订制任意长度

\*\* 标准锁紧螺母材质为黄铜镀镍

# M12电源系列预铸式连接器S-CODE

- 预铸接头:TPU材质,黑色
- 锁紧螺母:黄铜镀镍
- 针托:TPU材质,黑色
- 触点:黄铜镀金
- 密封圈:FPM/FKM
- 防护等级:IP67
- 电流等级:12A
- 电压等级:630VAC
- 绝缘电阻: $\geq 10^9 \Omega$
- 接触电阻: $\leq 5m\Omega$
- 污染等级:3
- 使用环境温度: $-40 \sim +80^\circ C$
- 可插拔寿命:最小100次
- 电缆最大外径: 9mm



预铸式连接器	型号	订货号	电缆	针脚编号分布
直线孔座.** 	PS-EK4-2M/P00 PS-EK4-5M/P00 PS-EK4-10M/P00	10093119 10093120 10093121	黑色PVC电缆 4*16AWG (4*1.5mm <sup>2</sup> ) Ø8.5mm 电缆型号: 58123911-*M	孔座  1.BK1 2.BK2 3.BK3 PE.GN/YE
直角孔座.** 	PS-ELK4-2M/P00 PS-ELK4-5M/P00 PS-ELK4-10M/P00	10093122 10093123 10093124		
直线针座.** 	PS-EZ4-2M/P00 PS-EZ4-5M/P00 PS-EZ4-10M/P00	10093125 10093126 10093127	黑色PVC电缆 4*16AWG (4*1.5mm <sup>2</sup> ) Ø8.5mm 电缆型号: 58123911-*M	针座  1.BK1 2.BK2 3.BK3 PE.GN/YE
直角针座.** 	PS-ELZ4-2M/P00 PS-ELZ4-5M/P00 PS-ELZ4-10M/P00	10093128 10093129 10093130		
直线孔座.** 	PS-EK4-2M/S10 PS-EK4-5M/S10 PS-EK4-10M/S10	10093131 10093132 10093133	黑色屏蔽PVC电缆 4*16AWG (4*1.5mm <sup>2</sup> ) Ø8.5mm 电缆型号: 58022151-*M	孔座  1.BK1 2.BK2 3.BK3 PE.GN/YE
直角孔座.** 	PS-ELK4-2M/S10 PS-ELK4-5M/S10 PS-ELK4-10M/S10	10093134 10093135 10093136		
直线针座.** 	PS-EZ4-2M/S10 PS-EZ4-5M/S10 PS-EZ4-10M/S10	10093137 10093138 10093139	黑色屏蔽PVC电缆 4*16AWG (4*1.5mm <sup>2</sup> ) Ø8.5mm 电缆型号: 58022151-*M	针座  1.BK1 2.BK2 3.BK3 PE.GN/YE
直角针座.** 	PS-ELZ4-2M/S10 PS-ELZ4-5M/S10 PS-ELZ4-10M/S10	10093140 10093141 10093142		

\* 标准长度为2/5/10米,可订制任意长度

\*\* 标准锁紧螺母材质为黄铜镀镍

## M12电源系列预铸式连接器L-CODE

- 预铸接头:TPU材质,黑色
- 锁紧螺母:黄铜镀镍
- 针托:TPU材质,黑色
- 触点:黄铜镀金
- 密封圈:FPM/FKM
- 防护等级:IP67
- 电流等级:12A(1.5mm<sup>2</sup>)
- 电压等级:63VDC
- 绝缘电阻:≥10<sup>9</sup>Ω
- 接触电阻:≤5mΩ
- 污染等级:3
- 使用环境温度:-40~+80°C
- 可插拔寿命:最小100次
- 电缆最大外径: 9mm



预铸式连接器	型号	订货号	电缆	针脚编号分布
直线孔座.** 	PL-EK5-2M/P00 PL-EK5-5M/P00 PL-EK5-10M/P00	10255654 10093143 10093114	黑色PVC电缆 5*16AWG (5*1.5mm <sup>2</sup> ) Ø8.6mm 电缆型号: 58118911-*M	孔座 
直角孔座.** 	PL-ELK5-2M/P00 PL-ELK5-5M/P00 PL-ELK5-10M/P00	10255656 10093145 10093146		1.BN 2.WH 3.BU 4.BK 5.GN/YE
直线针座.** 	PL-EZ5-2M/P00 PL-EZ5-5M/P00 PL-EZ5-10M/P00	10255655 10093147 10093148	黑色PVC电缆 5*16AWG (5*1.5mm <sup>2</sup> ) Ø8.6mm 电缆型号: 58118911-*M	针座 
直角针座.** 	PL-ELZ5-2M/P00 PL-ELZ5-5M/P00 PL-ELZ5-10M/P00	10255657 10093149 10093150		1.BN 2.WH 3.BU 4.BK 5.GN/YE
直线孔座.** 	PL-EK5-2M/S10 PL-EK5-5M/S10 PL-EK5-10M/S10	10093151 10093152 10093153	黑色屏蔽PVC电缆 5*16AWG (5*1.5mm <sup>2</sup> ) Ø8.6mm 电缆型号: 58118911-*M	孔座 
直角孔座.** 	PL-ELK5-2M/S10 PL-ELK5-5M/S10 PL-ELK5-10M/S10	10093154 10093155 10093156		1.BN 2.WH 3.BU 4.BK 5.GN/YE
直线针座.** 	PL-EZ5-2M/S10 PL-EZ5-5M/S10 PL-EZ5-10M/S10	10093157 10093158 10093159	黑色屏蔽PVC电缆 5*16AWG (5*1.5mm <sup>2</sup> ) Ø8.6mm 电缆型号: 58118911-*M	针座 
直角针座.** 	PL-ELZ5-2M/S10 PL-ELZ5-5M/S10 PL-ELZ5-10M/S10	10093160 10093161 10093162		1.BN 2.WH 3.BU 4.BK 5.GN/YE

\* 标准长度为2/5/10米,可订制任意长度

\*\* 标准锁紧螺母材质为黄铜镀镍

## M12电源系列预铸式连接器K-CODE

- 预铸接头:TPU材质,黑色
- 锁紧螺母:黄铜镀镍
- 针托:TPU材质,黑色
- 触点:黄铜镀金
- 密封圈:FPM/FKM
- 防护等级:IP67
- 电流等级:12A(1.5mm<sup>2</sup>)
- 电压等级:630VAC
- 绝缘电阻:≥10<sup>9</sup>Ω
- 接触电阻:≤5mΩ
- 污染等级:3
- 使用环境温度:-40~+80°C
- 可插拔寿命:最小100次
- 电缆最大外径: 9mm



预铸式连接器	型号	订货号	电缆	针脚编号分布
直线孔座.** 	PK-EK5-2M/P00 PK-EK5-5M/P00 PK-EK5-10M/P00	10130633 10093163 10093164	黑色PVC电缆 5*16AWG (5*1.5mm <sup>2</sup> ) Ø9.1mm 电缆型号: 58025151-*M	孔座 
直角孔座.** 	PK-ELK5-2M/P00 PK-ELK5-5M/P00 PK-ELK5-10M/P00	10255648 10093165 10093166		1.BK1 2.BK2 3.BK3 4.BK4 PE.GN/YE
直线针座.** 	PK-EZ5-2M/P00 PK-EZ5-5M/P00 PK-EZ5-10M/P00	10256162 10093167 10093168	黑色PVC电缆 5*16AWG (5*1.5mm <sup>2</sup> ) Ø9.1mm 电缆型号: 58025151-*M	针座 
直角针座.** 	PK-ELZ5-2M/P00 PK-ELZ5-5M/P00 PK-ELZ5-10M/P00	10255649 10093169 10093170		1.BK1 2.BK2 3.BK3 4.BK4 PE.GN/YE
直线孔座.** 	PK-EK5-2M/S10 PK-EK5-5M/S10 PK-EK5-10M/S10	10093171 10093172 10093173	黑色屏蔽PVC电缆 5*16AWG (5*1.5mm <sup>2</sup> ) Ø9.1mm 电缆型号: 58026151-*M	孔座 
直角孔座.** 	PK-ELK5-2M/S10 PK-ELK5-5M/S10 PK-ELK5-10M/S10	10093174 10093175 10093176		1.BK1 2.BK2 3.BK3 4.BK4 PE.GN/YE
直线针座.** 	PK-EZ5-2M/S10 PK-EZ5-5M/S10 PK-EZ5-10M/S10	10093177 10093178 10093179	黑色屏蔽PVC电缆 5*16AWG (5*1.5mm <sup>2</sup> ) Ø9.1mm 电缆型号: 58026151-*M	针座 
直角针座.** 	PK-ELZ5-2M/S10 PK-ELZ5-5M/S10 PK-ELZ5-10M/S10	10093180 10093181 10093182		1.BK1 2.BK2 3.BK3 4.BK4 PE.GN/YE

\* 标准长度为2/5/10米,可订制任意长度

\*\* 标准锁紧螺母材质为黄铜镀镍

## 4针/5针/8针M12全塑料外壳现场可接线连接器



现场可接线连接器	型号	订货号	特性描述	针脚编号分布
<p>M12x1 直线孔座 - 螺钉连接</p> <p>EK*111-0/7:</p> <p>EK*111-0/9:</p> <p>EK8111-0/11:</p>	EK4111-0/7	10091005	PA6+GF, PA6+GF黑色塑料锁头 PG 7 电缆出线口 可连接的电缆外径范围: 4-6 mm 可连接的最大线芯: 0.75 mm <sup>2</sup> 螺钉连接 85°C, 250 V, 4 A	
	EK4111-0/9	10091006	PA6+GF, PA6+GF黑色塑料锁头 PG 9 电缆出线口 可连接的电缆外径范围: 6-8 mm 可连接的最大线芯: 0.75 mm <sup>2</sup> 螺钉连接 85°C, 250 V, 4 A	
	EK5111-0/7	10091008	PA6+GF, PA6+GF黑色塑料锁头 PG 7 电缆出线口 可连接的电缆外径范围: 4-6 mm 可连接的最大线芯: 0.75 mm <sup>2</sup> 螺钉连接 85°C, 125 V, 4 A	
	EK5111-0/9	10091007	PA6+GF, PA6+GF黑色塑料锁头 PG 9 电缆出线口 可连接的电缆外径范围: 6-8 mm 可连接的最大线芯: 0.75 mm <sup>2</sup> 螺钉连接 85°C, 125 V, 4 A	
	EK8211-0/7	10091494	PA6+GF, PA6+GF黑色塑料锁头 PG 7 电缆出线口 可连接的电缆外径范围: 4-6 mm 可连接的最大线芯: 0.5 mm <sup>2</sup> 螺钉连接 85°C, 60 V, 2 A	
	EK8211-0/9	10093111	PA6+GF, PA6+GF黑色塑料锁头 PG 9 电缆出线口 可连接的电缆外径范围: 6-8 mm 可连接的最大线芯: 0.5 mm <sup>2</sup> 螺钉连接 85°C, 60 V, 2 A	
	EK8211-0/11	10091499	PA6+GF, PA6+GF黑色塑料锁头 PG 11 电缆出线口 可连接的电缆外径范围: 8-10 mm 可连接的最大线芯: 0.5mm <sup>2</sup> 螺钉连接 85°C, 60 V, 2 A	

## 4针/5针/8针M12全塑料外壳现场可接线连接器

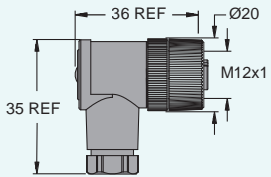
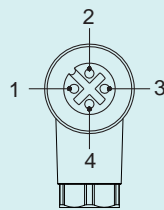
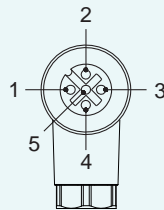
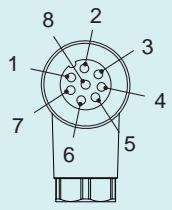

现场可接线连接器	型号	订货号	特性描述	针脚编号分布
	ELK4111-0/7	10091015	PA6+GF, PA6+GF黑色塑料锁头 PG 7 电缆出线口 可连接的电缆外径范围: 4-6 mm 可连接的最大线芯: 0.75 mm <sup>2</sup> 螺钉连接 85°C, 250 V, 4 A	
	ELK4111-0/9	10091016	PA6+GF, PA6+GF黑色塑料锁头 PG 9 电缆出线口 可连接的电缆外径范围: 6-8 mm 可连接的最大线芯: 0.75 mm <sup>2</sup> 螺钉连接 85°C, 250 V, 4 A	
	ELK5111-0/7	10091018	PA6+GF, PA6+GF黑色塑料锁头 PG 7 电缆出线口 可连接的电缆外径范围: 4-6 mm 可连接的最大线芯: 0.75 mm <sup>2</sup> 螺钉连接 85°C, 125 V, 4 A	
	ELK5111-0/9	10091017	PA6+GF, PG 9 电缆出线口 可连接的电缆外径范围: 6-8 mm 可连接的最大线芯: 0.75 mm <sup>2</sup> 螺钉连接 85°C, 125 V, 4 A	
	ELK8211-0/7	10091476	PA6+GF, PA6+GF黑色塑料锁头 PG 7 电缆出线口 可连接的电缆外径范围: 4-6 mm 可连接的最大线芯: 0.5 mm <sup>2</sup> 螺钉连接 85°C, 60 V, 2 A	
	ELK8211-0/9	10093111	PA6+GF, PA6+GF黑色塑料锁头 PG 9 电缆出线口 可连接的电缆外径范围: 6-8 mm 可连接的最大线芯: 0.5 mm <sup>2</sup> 螺钉连接 85°C, 60 V, 2 A	

## 4针/5针/8针透明M12全塑料外壳现场可接线连接器

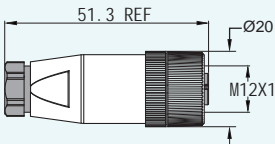
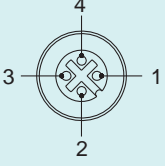
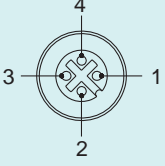
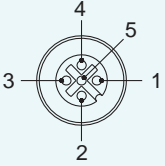
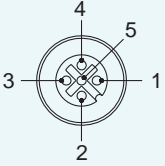
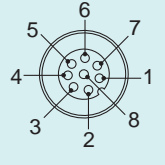
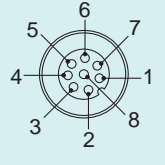

现场可接线连接器	型号	订货号	特性描述	针脚编号分布
M12x1 直线孔座 - 螺钉连接  	EK4114-0/7	10091025	透明/PC, PA6+GF黑色塑料锁头 PG 7 电缆出线口 可连接的电缆外径范围: 4-6 mm 可连接的最大线芯: 0.75 mm <sup>2</sup> 螺钉连接 85°C, 250 V, 4 A	
	EK4114-0/9	10091040	透明/PC, PA6+GF黑色塑料锁头 PG 9 电缆出线口 可连接的电缆外径范围: 6-8 mm 可连接的最大线芯: 0.75 mm <sup>2</sup> 螺钉连接 85°C, 250 V, 4 A	
	EK5114-0/7	10091028	透明/PC, PA6+GF黑色塑料锁头 PG 7 电缆出线口 可连接的电缆外径范围: 4-6 mm 可连接的最大线芯: 0.75 mm <sup>2</sup> 螺钉连接 85°C, 125 V, 4 A	
	EK5114-0/9	10091027	透明/PC, PA6+GF黑色塑料锁头 PG 9 电缆出线口 可连接的电缆外径范围: 6-8 mm 可连接的最大线芯: 0.75 mm <sup>2</sup> 螺钉连接 85°C, 125 V, 4 A	
	EK8114-0/7	10091075	透明/PC, PA6+GF黑色塑料锁头 PG 7 电缆出线口 可连接的电缆外径范围: 4-6 mm 可连接的最大线芯: 0.5 mm <sup>2</sup> 螺钉连接 85°C, 60 V, 2 A	
	EK8114-0/9	10091076	透明/PC, PA6+GF黑色塑料锁头 PG 9 电缆出线口 可连接的电缆外径范围: 6-8 mm 可连接的最大线芯: 0.5 mm <sup>2</sup> 螺钉连接 85°C, 60 V, 2 A	

## 4针/5针/8针透明M12全塑料外壳现场可接线连接器

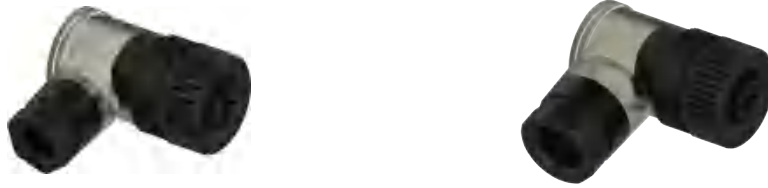

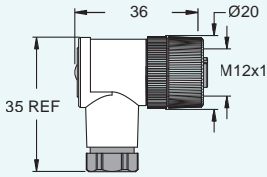
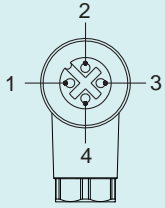
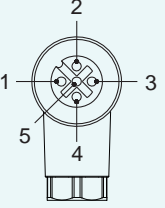
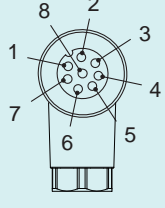
现场可接线连接器	型号	订货号	特性描述	针脚编号分布
M12x1 直角孔座 - 螺钉连接  	ELK4114-0/7	10091050	透明/PC, PA6+GF黑色塑料锁头 PG 7 电缆出线口 可连接的电缆外径范围: 4-6 mm 可连接的最大线芯: 0.75 mm <sup>2</sup> 螺钉连接 85°C, 250 V, 4 A	
	ELK4114-0/9	10091051	透明/PC, PA6+GF黑色塑料锁头 PG 9 电缆出线口 可连接的电缆外径范围: 6-8 mm 可连接的最大线芯: 0.75 mm <sup>2</sup> 螺钉连接 85°C, 250 V, 4 A	
	ELK5114-0/7	10091052	透明/PC, PA6+GF黑色塑料锁头 PG 7 电缆出线口 可连接的电缆外径范围: 4-6 mm 可连接的最大线芯: 0.75 mm <sup>2</sup> 螺钉连接 85°C, 125 V, 4 A	
	ELK5114-0/9	10091053	透明/PC, PA6+GF黑色塑料锁头 PG 9 电缆出线口 可连接的电缆外径范围: 6-8 mm 可连接的最大线芯: 0.75 mm <sup>2</sup> 螺钉连接 85°C, 125 V, 4 A	
	ELK8114-0/7	10091130	透明/PC, PA6+GF黑色塑料锁头 PG 7 电缆出线口 可连接的电缆外径范围: 4-6 mm 可连接的最大线芯: 0.5 mm <sup>2</sup> 螺钉连接 85°C, 60 V, 2 A	
	ELK8114-0/9	10091131	透明/PC, PA6+GF黑色塑料锁头 PG 9 电缆出线口 可连接的电缆外径范围: 6-8 mm 可连接的最大线芯: 0.5 mm <sup>2</sup> 螺钉连接 85°C, 60 V, 2 A	



现场可接线连接器	型号	订货号	特性描述	针脚编号分布
<p>M12x1 直线孔座 - 螺钉连接</p> <p>EK*112-0/7</p> <p>EK*112-0/9</p> <p>EK8112-0/11</p>	EK4112-0/7	10091325	PA6+GF黑色, 黄铜镀镍金属锁头 PG 7 电缆出线口 可连接的电缆外径范围: 4-6 mm 可连接的最大线芯: 0.75 mm <sup>2</sup> 螺钉连接 85°C, 250 V, 4 A	
	EK4112-0/9	10091331	PA6+GF黑色, 黄铜镀镍金属锁头 PG 9 电缆出线口 可连接的电缆外径范围: 6-8 mm 可连接的最大线芯: 0.75 mm <sup>2</sup> 螺钉连接 85°C, 250 V, 4 A	
	EK5112-0/7	10091335	PA6+GF黑色, 黄铜镀镍金属锁头 PG 7 电缆出线口 可连接的电缆外径范围: 4-6 mm 可连接的最大线芯: 0.75 mm <sup>2</sup> 螺钉连接 85°C, 125 V, 4 A	
	EK5112-0/9	10091332	PA6+GF黑色, 黄铜镀镍金属锁头 PG 9 电缆出线口 可连接的电缆外径范围: 6-8 mm 可连接的最大线芯: 0.75 mm <sup>2</sup> 螺钉连接 85°C, 125 V, 4 A	
	EK8212-0/7	10091554	PA6+GF黑色, 黄铜镀镍金属锁头 PG 7 电缆出线口 可连接的电缆外径范围: 4-6 mm 可连接的最大线芯: 0.5 mm <sup>2</sup> 螺钉连接 85°C, 60 V, 2 A	
	EK8212-0/9	10091402	PA6+GF黑色, 黄铜镀镍金属锁头 PG 9 电缆出线口 可连接的电缆外径范围: 6-8 mm 可连接的最大线芯: 0.5 mm <sup>2</sup> 螺钉连接 85°C, 60 V, 2 A	
	EK8212-0/11	10091555	PA6+GF黑色, 黄铜镀镍金属锁头 PG 11 电缆出线口 可连接的电缆外径范围: 8-10 mm 可连接的最大线芯: 0.5 mm <sup>2</sup> 螺钉连接 85°C, 60 V, 2 A	

## 4针/5针/8针M12塑料外壳金属锁头现场可接线连接器



现场可接线连接器	型号	订货号	特性描述	针脚编号分布
M12x1 直线针座 - 螺钉连接  EK*112-0/7  	EZ4112-0/7	10091318	PA6+GF黑色, 黄铜镀镍金属锁头 PG 7 电缆出线口 可连接的电缆外径范围: 4-6 mm 可连接的最大线芯: 0.75 mm <sup>2</sup> 螺钉连接 85°C, 250 V, 4 A	
	EZ4112-0/9	10091326	PA6+GF黑色, 黄铜镀镍金属锁头 PG 9 电缆出线口 可连接的电缆外径范围: 6-8 mm 可连接的最大线芯: 0.75 mm <sup>2</sup> 螺钉连接 85°C, 250 V, 4 A	
EK*112-0/9  	EZ5112-0/7	10091317	PA6+GF黑色, 黄铜镀镍金属锁头 PG 7 电缆出线口 可连接的电缆外径范围: 4-6 mm 可连接的最大线芯: 0.75 mm <sup>2</sup> 螺钉连接 85°C, 125 V, 4 A	
	EZ5112-0/9	10091334	PA6+GF黑色, 黄铜镀镍金属锁头 PG 9 电缆出线口 可连接的电缆外径范围: 6-8 mm 可连接的最大线芯: 0.75 mm <sup>2</sup> 螺钉连接 85°C, 125 V, 4 A	
EK8112-0/11  	EZ8212-0/7	10091557	PA6+GF黑色, 黄铜镀镍金属锁头 PG 7 电缆出线口 可连接的电缆外径范围: 4-6 mm 可连接的最大线芯: 0.5 mm <sup>2</sup> 螺钉连接 85°C, 60 V, 2 A	
	EZ8212-0/9	10091147	PA6+GF黑色, 黄铜镀镍金属锁头 PG 9 电缆出线口 可连接的电缆外径范围: 6-8 mm 可连接的最大线芯: 0.5 mm <sup>2</sup> 螺钉连接 85°C, 60 V, 2 A	
	EZ8212-0/11	10091558	PA6+GF黑色, 黄铜镀镍金属锁头 PG 11 电缆出线口 可连接的电缆外径范围: 8-10 mm 可连接的最大线芯: 0.5 mm <sup>2</sup> 螺钉连接 85°C, 60 V, 2 A	

## 4针/5针/8针M12塑料外壳金属锁头现场可接线连接器

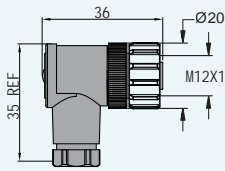
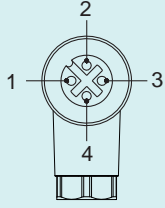
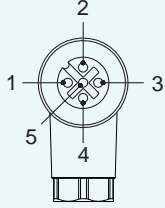
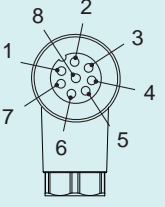

现场可接线连接器	型号	订货号	特性描述	针脚编号分布
M12x1 直角孔座 - 螺钉连接  	ELK4112-0/7	10091327	PA6+GF黑色, 黄铜镀镍金属锁头 PG 7 电缆出线口 可连接的电缆外径范围: 4-6 mm 可连接的最大线芯: 0.75 mm <sup>2</sup> 螺钉连接 85°C, 250 V, 4 A	
	ELK4112-0/9	10091408	PA6+GF黑色, 黄铜镀镍金属锁头 PG 9 电缆出线口 可连接的电缆外径范围: 6-8 mm 可连接的最大线芯: 0.75 mm <sup>2</sup> 螺钉连接 85°C, 250 V, 4 A	
	ELK5112-0/7	10091319	PA6+GF黑色, 黄铜镀镍金属锁头 PG 7 电缆出线口 可连接的电缆外径范围: 4-6 mm 可连接的最大线芯: 0.75 mm <sup>2</sup> 螺钉连接 85°C, 125 V, 4 A	
	ELK5112-0/9	10091012	PA6+GF黑色, 黄铜镀镍金属锁头 PG 9 电缆出线口 可连接的电缆外径范围: 6-8 mm 可连接的最大线芯: 0.75 mm <sup>2</sup> 螺钉连接 85°C, 125 V, 4 A	
	ELK8112-0/7	10091134	PA6+GF黑色, 黄铜镀镍金属锁头 PG 7 电缆出线口 可连接的电缆外径范围: 4-6 mm 可连接的最大线芯: 0.5 mm <sup>2</sup> 螺钉连接 85°C, 60 V, 2 A	
	ELK8112-0/9	10091135	PA6+GF黑色, 黄铜镀镍金属锁头 PG 9 电缆出线口 可连接的电缆外径范围: 6-8 mm 可连接的最大线芯: 0.5 mm <sup>2</sup> 螺钉连接 85°C, 60 V, 2 A	

## 4针/5针/8针M12塑料外壳金属锁头现场可接线连接器

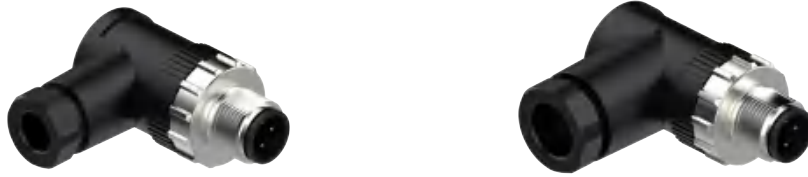

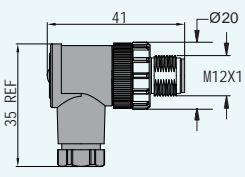
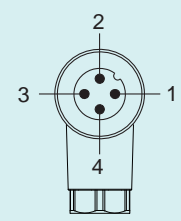
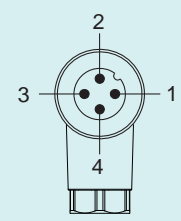
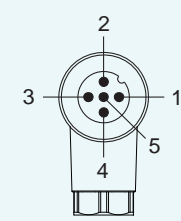
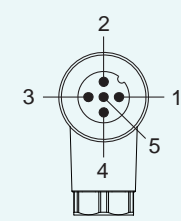
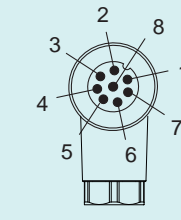
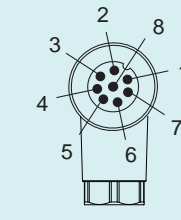
现场可接线连接器	型号	订货号	特性描述	针脚编号分布
M12x1 直角针座 - 螺钉连接  	ELZ4112-0/7	10091337	PA6+GF黑色, 黄铜镀镍金属锁头 PG 7 电缆出线口 可连接的电缆外径范围: 4-6 mm 可连接的最大线芯: 0.75 mm <sup>2</sup> 螺钉连接 85°C, 250 V, 4 A	
	ELZ4112-0/9	10091443	PA6+GF黑色, 黄铜镀镍金属锁头 PG 9 电缆出线口 可连接的电缆外径范围: 6-8 mm 可连接的最大线芯: 0.75 mm <sup>2</sup> 螺钉连接 85°C, 250 V, 4 A	
	ELZ5112-0/7	10091445	PA6+GF黑色, 黄铜镀镍金属锁头 PG 7 电缆出线口 可连接的电缆外径范围: 4-6 mm 可连接的最大线芯: 0.75 mm <sup>2</sup> 螺钉连接 85°C, 125 V, 4 A	
	ELZ5112-0/9	10091447	PA6+GF黑色, 黄铜镀镍金属锁头 PG 9 电缆出线口 可连接的电缆外径范围: 6-8 mm 可连接的最大线芯: 0.75 mm <sup>2</sup> 螺钉连接 85°C, 125 V, 4 A	
	ELZ8212-0/7	10091498	PA6+GF黑色, 黄铜镀镍金属锁头 PG 7 电缆出线口 可连接的电缆外径范围: 4-6 mm 可连接的最大线芯: 0.5 mm <sup>2</sup> 螺钉连接 85°C, 60 V, 2 A	
	ELZ8212-0/9	10091495	PA6+GF黑色, 黄铜镀镍金属锁头 PG 9 电缆出线口 可连接的电缆外径范围: 6-8 mm 可连接的最大线芯: 0.5 mm <sup>2</sup> 螺钉连接 85°C, 60 V, 2 A	

## 4针/5针/8针全金属型M12现场可接线连接器

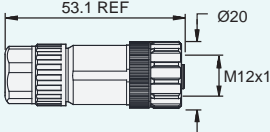
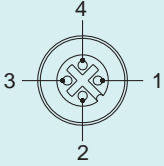
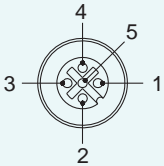
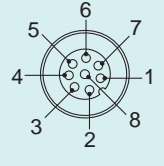
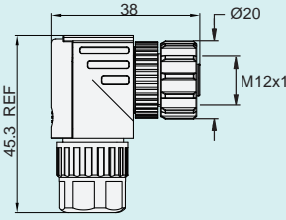
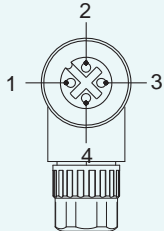
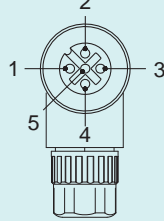
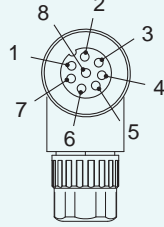

现场可接线连接器	型号	订货号	特性描述	针脚编号分布
M12x1 直线孔座 - 螺钉连接  	EK4218-0/9	10091338	黄铜镀镍 可连接的电缆外径范围: 6-8 mm 可连接的最大线芯: 0.75 mm <sup>2</sup> 螺钉连接 85°C, 250 V, 4 A	
	EK5218-0/9	10091340	黄铜镀镍 可连接的电缆外径范围: 6-8 mm 可连接的最大线芯: 0.75 mm <sup>2</sup> 螺钉连接 85°C, 125 V, 4 A	
	EK8218-0/9	10091346	黄铜镀镍 可连接的电缆外径范围: 6-8 mm 可连接的最大线芯: 0.5 mm <sup>2</sup> 螺钉连接 85°C, 60 V, 2 A	
M12x1 直角孔座 - 螺钉连接  	ELK4218-0/9	10091251	黄铜镀镍 可连接的电缆外径范围: 6-8 mm 可连接的最大线芯: 0.75 mm <sup>2</sup> 螺钉连接 85°C, 250 V, 4 A	
	ELK5218-0/9	10091271	黄铜镀镍 可连接的电缆外径范围: 6-8 mm 可连接的最大线芯: 0.75 mm <sup>2</sup> 螺钉连接 85°C, 125 V, 4 A	
	ELK8218-0/9	10091062	黄铜镀镍 可连接的电缆外径范围: 6-8 mm 可连接的最大线芯: 0.5 mm <sup>2</sup> 螺钉连接 85°C, 60 V, 2 A	

## 4针/5针/8针全金属型M12现场可接线连接器

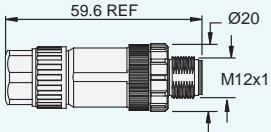
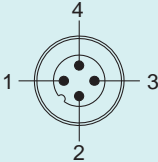
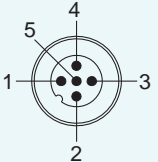
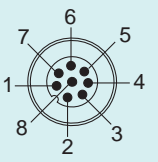
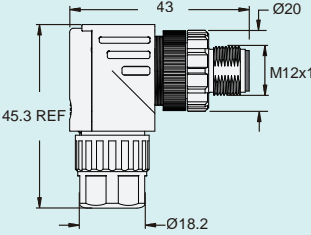
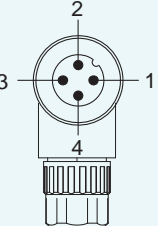
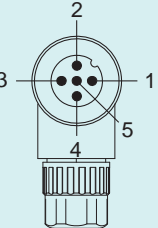
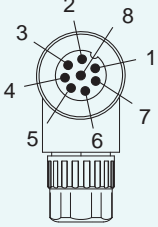

现场可接线连接器	型号	订货号	特性描述	针脚编号分布
M12x1 直线针座 - 螺钉连接  	EZ4218-0/9	10091341	黄铜镀镍 可连接的电缆外径范围：6-8 mm 可连接的最大线芯：0.75 mm <sup>2</sup> 螺钉连接 85°C, 250 V, 4 A	
	EZ5218-0/9	10091342	黄铜镀镍 可连接的电缆外径范围：6-8 mm 可连接的最大线芯：0.75 mm <sup>2</sup> 螺钉连接 85°C, 125 V, 4 A	
	EZ8218-0/9	10091490	黄铜镀镍 可连接的电缆外径范围：6-8 mm 可连接的最大线芯：0.5 mm <sup>2</sup> 螺钉连接 85°C, 60 V, 2 A	
M12x1 直角针座 - 螺钉连接  	ELZ4218-0/9	10091241	黄铜镀镍 可连接的电缆外径范围：6-8 mm 可连接的最大线芯：0.75 mm <sup>2</sup> 螺钉连接 85°C, 250 V, 4 A	
	ELZ5218-0/9	10091261	黄铜镀镍 可连接的电缆外径范围：6-8 mm 可连接的最大线芯：0.75 mm <sup>2</sup> 螺钉连接 85°C, 125 V, 4 A	
	ELZ8218-0/9	10091063	黄铜镀镍 可连接的电缆外径范围：6-8 mm 可连接的最大线芯：0.5 mm <sup>2</sup> 螺钉连接 85°C, 60 V, 2 A	

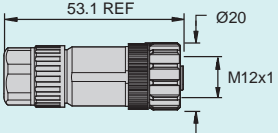
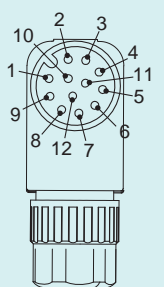
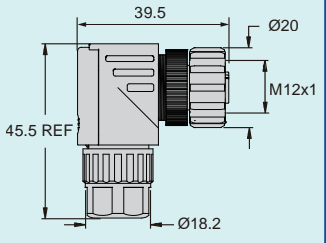
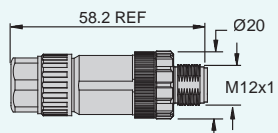
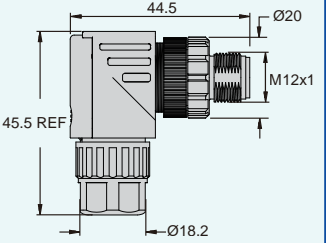

现场可接线连接器	型号	订货号	特性描述	针脚编号分布
M12x1 直线孔座 - 焊接连接 	EK12218-0/9/L	10091289	黄铜镀镍 可连接的电缆外径范围: 6-8 mm 可连接的最大线芯: 0.25 mm <sup>2</sup> 焊接连接 85°C, 60 V, 2 A	
M12x1 直角孔座 - 焊接连接 	ELK12218-0/9/L	10091290		
M12x1 直线针座 - 焊接连接 	EZ12218-0/9/L	10091381		
M12x1 直角针座 - 焊接连接 	ELZ12218-0/9/L	10091380		

## 4针/5针/8针不锈钢型M12现场可接线连接器



现场可接线连接器	型号	订货号	特性描述	针脚编号分布
M12x1 直线孔座 - 螺钉连接  	EK4219-0/9	10091267	不锈钢 可连接的电缆外径范围：6-8 mm 可连接的最大线芯：0.75 mm <sup>2</sup> 螺钉连接 85°C, 250 V, 4 A	
	EK5219-0/9	10091268	不锈钢 可连接的电缆外径范围：6-8 mm 可连接的最大线芯：0.75 mm <sup>2</sup> 螺钉连接 85°C, 125 V, 4 A	
	EK8219-0/9	10091286	不锈钢 可连接的电缆外径范围：6-8 mm 可连接的最大线芯：0.5 mm <sup>2</sup> 螺钉连接 85°C, 60 V, 2 A	
M12x1 直线针座 - 螺钉连接  	EZ4219-0/9	10091287	不锈钢 可连接的电缆外径范围：6-8 mm 可连接的最大线芯：0.75 mm <sup>2</sup> 螺钉连接 85°C, 250 V, 4 A	
	EZ5219-0/9	10091280	不锈钢 可连接的电缆外径范围：6-8 mm 可连接的最大线芯：0.75 mm <sup>2</sup> 螺钉连接 85°C, 125 V, 4 A	
	EZ8219-0/9	10091288	不锈钢 可连接的电缆外径范围：6-8 mm 可连接的最大线芯：0.5 mm <sup>2</sup> 螺钉连接 85°C, 60 V, 2 A	

## 4针/5针双电缆输出M12现场可接线连接器

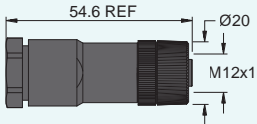
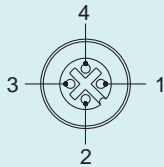
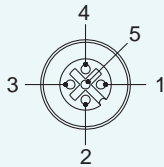
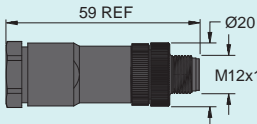
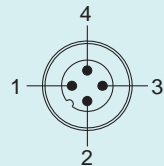
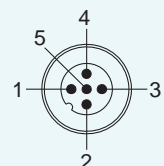

现场可接线连接器	型号	订货号	特性描述	针脚编号分布
M12x1 直线孔座 - 螺钉连接  	EK4111-1/11	10091105	PA6+GF黑色, PA6+GF黑色塑料锁头 可连接的电缆外径范围: 2*(3-5)mm 可连接的最大线芯: 0.75 mm <sup>2</sup> 螺钉连接 85°C, 250 V, 4 A	
	EK5111-1/11	10091107	PA6+GF黑色, PA6+GF黑色塑料锁头 可连接的电缆外径范围: 2*(3-5)mm 可连接的最大线芯: 0.75 mm <sup>2</sup> 螺钉连接 85°C, 125 V, 4 A	
M12x1 直线针座 - 螺钉连接  	EZ4111-1/11	10091115	PA6+GF黑色, PA6+GF黑色塑料锁头 可连接的电缆外径范围: 2*(3-5)mm 可连接的最大线芯: 0.75 mm <sup>2</sup> 螺钉连接 85°C, 250 V, 4 A	
	EZ5111-1/11	10091117	PA6+GF黑色, PA6+GF黑色塑料锁头 可连接的电缆外径范围: 2*(3-5)mm 可连接的最大线芯: 0.75 mm <sup>2</sup> 螺钉连接 85°C, 125 V, 4 A	

## 4针/5针双电缆输出M12现场可接线连接器

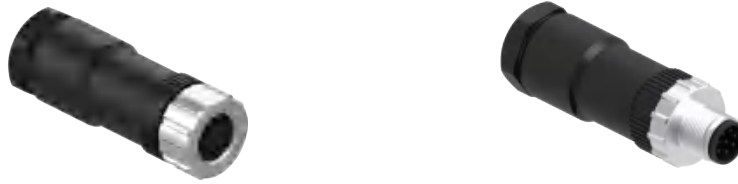

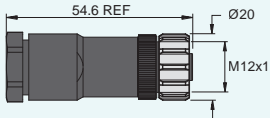
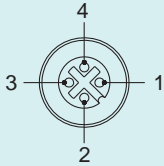
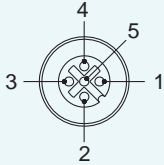
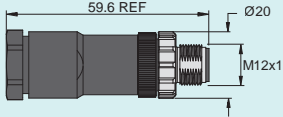
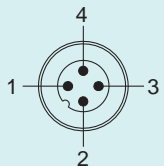
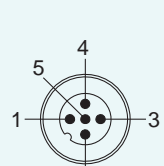
现场可接线连接器	型号	订货号	特性描述	针脚编号分布
M12x1 直线孔座 - 螺钉连接 	EK4112-1/11	10091106	PA6+GF黑色, 黄铜镀镍金属锁头 可连接的电缆外径范围: 2*(3-5)mm 可连接的最大线芯: 0.75 mm <sup>2</sup> 螺钉连接 85°C, 250 V, 4 A	
	EK5112-1/11	10091108	PA6+GF黑色, 黄铜镀镍金属锁头 可连接的电缆外径范围: 2*(3-5)mm 可连接的最大线芯: 0.75 mm <sup>2</sup> 螺钉连接 85°C, 125 V, 4 A	
M12x1 直线针座 - 螺钉连接 	EZ4112-1/11	10091328	PA6+GF黑色, 黄铜镀镍金属锁头 可连接的电缆外径范围: 2*(3-5)mm 可连接的最大线芯: 0.75 mm <sup>2</sup> 螺钉连接 85°C, 250 V, 4 A	
	EZ5112-1/11	10091552	PA6+GF黑色, 黄铜镀镍金属锁头 可连接的电缆外径范围: 2*(3-5)mm 可连接的最大线芯: 0.75 mm <sup>2</sup> 螺钉连接 85°C, 125 V, 4 A	

## 4针/5针双电缆输出M12现场可接线连接器



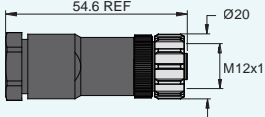
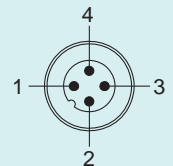



现场可接线连接器	型号	订货号	特性描述	针脚编号分布
M12x1 直线孔座 - 螺钉连接 	EK4112-2/11	10091614	PA6+GF黑色, 黄铜镀镍金属锁头 可连接的电缆外径范围: 2*(3-5)mm 可连接的最大线芯: 0.75 mm <sup>2</sup> 双输出双接线口 螺钉连接 85°C, 250 V, 4 A	
M12x1 直线针座 - 螺钉连接 	EZ4112-2/11	10091614	PA6+GF黑色, 黄铜镀镍金属锁头 可连接的电缆外径范围: 2*(3-5)mm 可连接的最大线芯: 0.75 mm <sup>2</sup> 双输出双接线口 螺钉连接 85°C, 250 V, 4 A	

## 4针M12刺破式现场可接线连接器



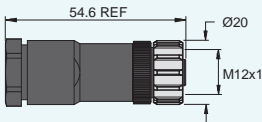

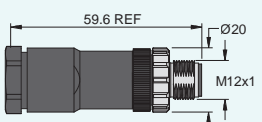
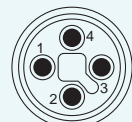
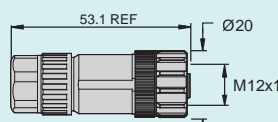

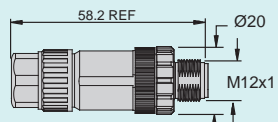
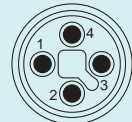
现场可接线连接器	型号	订货号	特性描述	针脚编号分布
M12x1 直线针座 - 刺破式 	EZ4212-0/7/IDC	10091238	PA6+GF黑色,黄铜镀镍金属锁头 尾端 可连接的电缆外径范围: 4-6 mm 可连接的线芯范围: 0.14~0.34 mm <sup>2</sup> -25~+85°C 250V, 4 A	针座 
M12x1 直线针座 - 刺破式 	EZ4238-0/9/IDC	10091236	锌镀镍外壳, 黄铜镀镍金属锁头 可连接的电缆外径范围: 6-10 mm 可连接的线芯范围: 0.14~0.34 mm <sup>2</sup> -25~+85°C 250V, 4 A	针座 

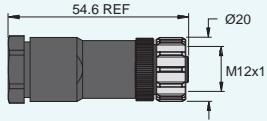

现场可接线连接器	型号	订货号	特性描述	针脚编号分布
M12x1 直线孔座 - 螺钉连接 	EK4242-0/11	10091258	PA6+GF黑色, 黄铜镀镍金属锁头 PG 11 电缆出线口 可连接的电缆外径范围: 8-10 mm 可连接的最大线芯: 1.5 mm <sup>2</sup> 螺钉连接 85°C, 63 VDC, 12 A	孔座 
M12x1 直线针座 - 螺钉连接 	EZ4242-0/11	10091556		针座 
M12x1 直线孔座 - 螺钉连接 	EK4248-0/9	10091045	锌合金/镀镍 PG 9 电缆出线口 可连接的电缆外径范围: 6-8 mm 可连接的最大线芯: 1.5 mm <sup>2</sup> 螺钉连接 85°C, 63 VDC, 12 A	孔座 
M12x1 直线针座 - 螺钉连接 	EZ4248-0/9	10091041		针座 

## 4针M12 S-Code现场可接线连接器

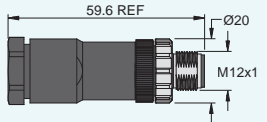
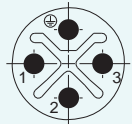
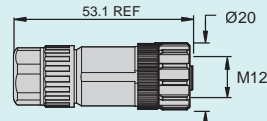

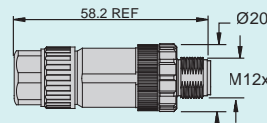
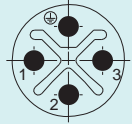
现场可接线连接器	型号	订货号	特性描述	针脚编号分布
M12x1 直线孔座 - 螺钉连接 	EK4252-0/11	10091323	PA6+GF黑色, 黄铜镀镍金属锁头 PG 11 电缆出线口 可连接的电缆外径范围: 8-10 mm 可连接的最大线芯: 1.5 mm <sup>2</sup> 螺钉连接 85°C, 630 VAC, 12 A	孔座 
M12x1 直线针座 - 螺钉连接 	EZ4252-0/11	10091322	可连接的最大线芯: 1.5 mm <sup>2</sup> 螺钉连接 85°C, 630 VAC, 12 A	针座 
M12x1 直线孔座 - 螺钉连接 	EK4258-0/9	10091560	锌合金/镀镍 PG 9 电缆出线口 可连接的电缆外径范围: 6-8 mm 可连接的最大线芯: 1.5 mm <sup>2</sup> 螺钉连接 85°C, 630 VAC, 12 A	孔座 
M12x1 直线针座 - 螺钉连接 	EZ4258-0/9	10091561	可连接的最大线芯: 1.5 mm <sup>2</sup> 螺钉连接 85°C, 630 VAC, 12 A	针座 



现场可接线连接器	型号	订货号	特性描述	针脚编号分布
M12x1 直线孔座 - 螺钉连接 	EK5272-0/11	10091351	PA6+GF黑色, 黄铜镀镍金属锁头 PG11 电缆出线口 可连接的电缆外径范围: 8-10 mm 可连接的线芯: 1.5 mm <sup>2</sup> 螺钉连接 85°C, 63 VDC, 12A	孔座 
M12x1 直线针座 - 螺钉连接 	EZ5272-0/11	10091352		针座 
M12x1 直线孔座 - 螺钉连接 	EK5278-0/9	10091405		孔座 
M12x1 直线针座 - 螺钉连接 	EZ5278-0/9	10091399		针座 

## 5针M12 K-Code现场可接线连接器

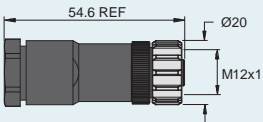
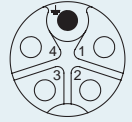
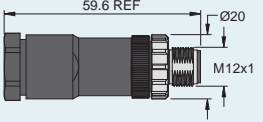
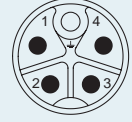
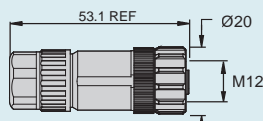
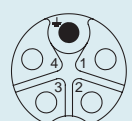
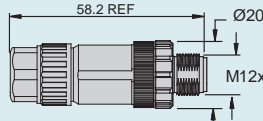
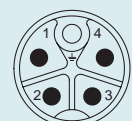

现场可接线连接器	型号	订货号	特性描述	针脚编号分布
M12x1 直线孔座 - 螺钉连接 	EK5282-0/11	10091359	PA6+GF/黑色, 黄铜镀镍金属锁头 PG11 电缆出线口 可连接的电缆外径范围: 8-10 mm 可连接的线芯: 1.5 mm <sup>2</sup> 螺钉连接 85°C, 630VAC, 12A	孔座 
M12x1 直线针座 - 螺钉连接 	EZ5282-0/11	10091358		针座 
M12x1 直线孔座 - 螺钉连接 	EK5288-0/9	10091491		孔座 
M12x1 直线针座 - 螺钉连接 	EZ5288-0/9	10091492		针座 



法兰连接器	型号	订货号	特性描述	针脚编号分布
<p>M12x1 前端锁紧,出线 孔座</p> <p>适配螺母</p> <p>开孔尺寸</p>	FEK31-0.5 FEK31-1.0	10041500 10041598	3x0.34mm <sup>2</sup> PVC 105°C 250V 4A	<p>1.BN 2.N/C 3.BU 4.BK</p>
	FEK41-0.5 FEK41-1.0	5P100154 10041516	4x0.34mm <sup>2</sup> PVC 105°C 250V 4A	<p>1.BN 2.WH 3.BU 4.BK</p>
	FEK51-0.5 FEK51-1.0	10041520 10041521	4x0.34mm <sup>2</sup> +1x0.5mm <sup>2</sup> PVC 105°C 125V 4A	<p>1.BN 2.WH 3.BU 4.BK 5.GN</p>
	FEK61-0.5 FEK61-1.0	10041530 10041560	6x0.25mm <sup>2</sup> PVC 105°C 60V 2A	<p>1.BN 2.WH 3.BU 4.BK 5.GY 6.PK</p>
	FEK81-0.5 FEK81-1.0	10041550 10041570	8x0.25mm <sup>2</sup> PVC 105°C 60V 2A	<p>1.WH 2.BN 3.GN 4.YE 5.GY 6.PK 7.BU 8.RD</p>
	FEK121-0.5 FEK121-1.0	10048057 10048058	12x0.25mm <sup>2</sup> PVC 105°C 60V 2A	<p>1.WH 2.BN 3.GN 4.YE 5.GY 6.PK 7.BU 8.RD 9.OG 10.TN 11.BK 12.VT</p>

# 3针/4针/5针/6针/8针/12针M12法兰连接器





法兰连接器	型号	订货号	特性描述	针脚编号分布
<p>M12x1 前端锁紧,出线 针座</p> <p>适配螺母</p> <p>开孔尺寸</p>	FEZ31-0.5 FEZ31-1.0	10041600 10041571	3x0.34mm <sup>2</sup> PVC 105°C 250V 4A	<p>1.BN 3.BU 4.BK</p>
	FEZ41-0.5 FEZ41-1.0	10041610 10041518	4x0.34mm <sup>2</sup> PVC 105°C 250V 4A	<p>1.BN 2.WH 3.BU 4.BK</p>
	FEZ51-0.5 FEZ51-1.0	10041620 10041621	4x0.34mm <sup>2</sup> +1x0.5mm <sup>2</sup> PVC 105°C 250V 4A	<p>1.BN 2.WH 3.BU 4.BK 5.GN/YE</p>
	FEZ61-0.5 FEZ61-1.0	10041630 10041572	6x0.25mm <sup>2</sup> PVC 105°C 60V 2A	<p>1.BN 2.WH 3.BU 4.BK 5.GY 6.PK</p>
	FEZ81-0.5 FEZ81-1.0	10041650 10041573	8x0.25mm <sup>2</sup> PVC 105°C 60V 2A	<p>1.WH 2.BN 3.GN 4.YE 5.GY 6.PK 7.BU 8.RD</p>
	FEZ121-0.5 FEZ121-1.0	10048060 10048059	12x0.25mm <sup>2</sup> PVC 105°C 60V 2A	<p>1.WH 2.BN 3.GN 4.YE 5.GY 6.PK 7.BU 8.RD 9.OG 10.TN 11.BK 12.VT</p>



法兰连接器	型号	订货号	特性描述	针脚编号分布
<p>M12x1 前端锁紧,出线 孔座</p> <p>适配螺母</p> <p>开孔尺寸</p>	<p>FEK171-0.5 FEK171-1.0</p>	<p>10046035 10255282</p>	<p>17x0.14mm<sup>2</sup> 无卤素TPE绞线 -40°C~85°C 30V 1.5A</p>	<ul style="list-style-type: none"> <li>1.BN</li> <li>2.BU</li> <li>3.WH</li> <li>4.GN</li> <li>5.PK</li> <li>6.YE</li> <li>7.BK</li> <li>8.GY</li> <li>9.RD</li> <li>10.VT</li> <li>11.GY/PK</li> <li>12.RD/BU</li> <li>13.WH/GN</li> <li>14.BN/GN</li> <li>15.WH/YE</li> <li>16.YE/BN</li> <li>17.WH/GY</li> </ul>

# 3针/4针/5针/6针/8针/12针M12 法兰连接器(可调)

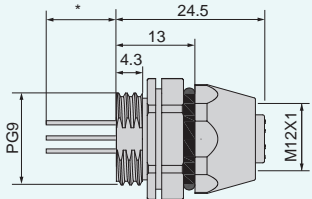
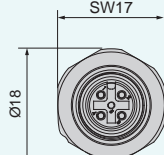
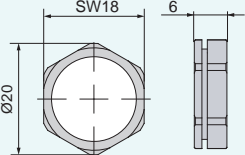
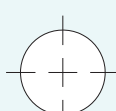
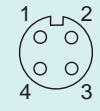
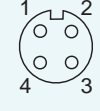
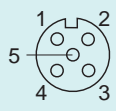
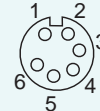
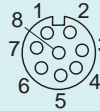

法兰连接器	型号	订货号	特性描述	针脚编号分布
<p>M12x1 锁紧螺纹长度可调节型 后端锁紧,出线 孔座</p>    <p>适配螺母</p>  <p>开孔建议开PG9螺纹孔</p>	FEK32-0.5 FEK32-1.0	10041538 10041539	3x0.34mm <sup>2</sup> PVC 105°C 250V 4A	 <p>1.BN 2.N/C 3.BU 4.BK</p>
	FEK42-0.5 FEK42-1.0	10049010 10049011	4x0.34mm <sup>2</sup> PVC 105°C 250V 4A	 <p>1.BN 2.WH 3.BU 4.BK</p>
	FEK52-0.5 FEK52-1.0	10049020 10041531	4x0.34mm <sup>2</sup> +1x0.5mm <sup>2</sup> PVC 105°C 250V 4A	 <p>1.BN 2.WH 3.BU 4.BK 5.GNVE</p>
	FEK62-0.5 FEK62-1.0	10041534 10041535	6x0.25mm <sup>2</sup> PVC 105°C 60V 2A	 <p>1.BN 2.WH 3.BU 4.BK 5.GY 6.PK</p>
	FEK82-0.5 FEK82-1.0	10041536 10041537	8x0.25mm <sup>2</sup> PVC 105°C 60V 2A	 <p>1.WH 2.BN 3.GN 4.YE 5.GY 6.PK 7.BU 8.RD</p>
	FEK122-0.5 FEK122-1.0	10048061 10041574	12x0.25mm <sup>2</sup> PVC 105°C 60V 2A	 <p>1.WH 2.BN 3.GN 4.YE 5.GY 9.OG 6.PK 10.TN 7.BU 11.BK 8.RD 12.VT</p>



法兰连接器	型号	订货号	特性描述	针脚编号分布
<p>M12x1 锁紧螺纹长度可调节型 后端锁紧,出线 针座</p> <p>适配螺母</p> <p>开孔建议开PG9螺纹孔</p>	FEZ32-0.5 FEZ32-1.0	10041576 10041577	3x0.34mm <sup>2</sup> PVC 105°C 250V 4A	<p>1.BN 3.BU 4.BK</p>
	FEZ42-0.5 FEZ42-1.0	10049110 10049111	4x0.34mm <sup>2</sup> PVC 105°C 250V 4A	<p>1.BN 2.WH 3.BU 4.BK</p>
	FEZ52-0.5 FEZ52-1.0	10041122 10041578	4x0.34mm <sup>2</sup> +1x0.5mm <sup>2</sup> PVC 105°C 250V 4A	<p>1.BN 2.WH 3.BU 4.BK 5.GN/YE</p>
	FEZ62-0.5 FEZ62-1.0	10041579 10041680	6x0.25mm <sup>2</sup> PVC 105°C 60V 2A	<p>1.BN 2.WH 3.BU 4.BK 5.GY 6.PK</p>
	FEZ82-0.5 FEZ82-1.0	10046404 10041681	8x0.25mm <sup>2</sup> PVC 105°C 60V 2A	<p>1.WH 2.BN 3.GN 4.YE 5.GY 6.PK 7.BU 8.RD</p>
	FEZ122-0.5 FEZ122-1.0	10048071 10048062	12x0.25mm <sup>2</sup> PVC 105°C 60V 2A	<p>1.WH 2.BN 3.GN 4.YE 5.GY 6.PK 7.BU 8.RD 9.OG 10.TN 11.BK 12.VT</p>

# 3针/4针/5针/6针/8针/12针M12法兰连接器 (短型)



法兰连接器	型号	订货号	特性描述	针脚编号分布
<p>M12x1 短型后端锁紧, 出线 孔座</p> <p>适配螺母</p> <p>开孔尺寸</p>	FEK321-0.5 FEK321-1.0	10048055 10048056	3x0.34mm <sup>2</sup> PVC 105°C 250V 4A	<p>1.BN 2.N/C 3.BU 4.BK</p>
	FEK421-0.5 FEK421-1.0	10047010 10048063	4x0.34mm <sup>2</sup> PVC 105°C 250V 4A	<p>1.BN 2.WH 3.BU 4.BK</p>
	FEK521-0.5 FEK521-1.0	10046081 10048064	4x0.34mm <sup>2</sup> +1x0.5mm <sup>2</sup> PVC 105°C 250V 4A	<p>1.BN 2.WH 3.BU 4.BK 5.GNVE</p>
	FEK621-0.5 FEK621-1.0	10048065 10048066	6x0.25mm <sup>2</sup> PVC 105°C 60V 2A	<p>1.BN 2.WH 3.BU 4.BK 5.GY 6.PK</p>
	FEK821-0.5 FEK821-1.0	10048067 10048068	8x0.25mm <sup>2</sup> PVC 105°C 60V 2A	<p>1.WH 2.BN 3.GN 4.YE 5.GY 6.PK 7.BU 8.RD</p>
	FEK1221-0.5 FEK1221-1.0	10048069 10041575	12x0.25mm <sup>2</sup> PVC 105°C 60V 2A	<p>1.WH 2.BN 3.GN 4.YE 5.GY 9.OG 6.PK 10.TN 7.BU 11.BK 8.RD 12.VT</p>

## 3针/4针/5针/6针/8针/12针M12 法兰连接器 (短型)



法兰连接器	型号	订货号	特性描述	针脚编号分布
<p>M12x1 短型后端锁紧,出线 针座</p> <p>适配螺母</p> <p>开孔尺寸</p>	FEZ321-0.5 FEZ321-1.0	10048073 10048074	3x0.34mm <sup>2</sup> PVC 105°C 250V 4A	<p>1.BN 3.BU 4.BK</p>
	FEZ421-0.5 FEZ421-1.0	10048075 10048076	4x0.34mm <sup>2</sup> PVC 105°C 250V 4A	<p>1.BN 2.WH 3.BU 4.BK</p>
	FEZ521-0.5 FEZ521-1.0	10048077 10048078	4x0.34mm <sup>2</sup> +1x0.5mm <sup>2</sup> PVC 105°C 125V 4A	<p>1.BN 2.WH 3.BU 4.BK 5.GN/YE</p>
	FEZ621-0.5 FEZ621-1.0	10048079 10048080	6x0.25mm <sup>2</sup> PVC 105°C 60V 2A	<p>1.BN 2.WH 3.BU 4.BK 5.GY 6.PK</p>
	FEZ821-0.5 FEZ821-1.0	10048081 10048082	8x0.25mm <sup>2</sup> PVC 105°C 60V 2A	<p>1.WH 2.BN 3.GN 4.YE 5.GY 6.PK 7.BU 8.RD</p>
	FEZ1221-0.5 FEZ1221-1.0	10048083 10048084	12x0.25mm <sup>2</sup> PVC 105°C 60V 2A	<p>1.WH 2.BN 3.GN 4.YE 5.GY 6.PK 7.BU 8.RD 9.OG 10.TN 11.BK 12.VT</p>

# 17针M12法兰连接器(短型)



法兰连接器	型号	订货号	特性描述	针脚编号分布
<p>M12x1 短型后端锁紧,出线 针座</p> <p>适配螺母</p> <p>开孔尺寸</p>	<p>FEZ1721-0.5 FEZ1721-1.0</p>	<p>10255283 10255284</p>	<p>17x0.14mm<sup>2</sup> 无卤素TPE绞线 -40°C~85°C 30V 1.5A</p>	<ul style="list-style-type: none"> <li>1.BN</li> <li>2.BU</li> <li>3.WH</li> <li>4.GN</li> <li>5.PK</li> <li>6.YE</li> <li>7.BK</li> <li>8.GY</li> <li>9.RD</li> <li>10.VT</li> <li>11.GY/PK</li> <li>12.RD/BU</li> <li>13.WH/GN</li> <li>14.BN/GN</li> <li>15.WH/YE</li> <li>16.YE/BN</li> <li>17.WH/GY</li> </ul>



法兰连接器	型号	订货号	特性描述	针脚编号分布
<p>M12 前端锁紧, 焊接 孔座</p>	FEK31-L	10041502	焊接 105°C 250V 4A	
	FEK41-L	10041512	焊接 105°C 250V 4A	
	FEK51-L	10041522	焊接 105°C 125V 4A	
	FEK61-L	10041532	焊接 105°C 60V 2A	
	FEK81-L	10041552	焊接 105°C 60V 2A	

# 3针/4针/5针/6针/8针M12 法兰连接器





法兰连接器	型号	订货号	特性描述	针脚编号分布
<p>M12 前端锁紧, 焊接 针座</p> <p>适配螺母</p> <p>开孔尺寸</p>	FEZ31-L	10041602	焊接 105°C 250V 4A	
	FEZ41-L	10041612	焊接 105°C 250V 4A	
	FEZ51-L	10041622	焊接 105°C 125V 4A	
	FEZ61-L	10041632	焊接 105°C 60V 2A	
	FEZ81-L	10041652	焊接 105°C 60V 2A	



法兰连接器	型号	订货号	特性描述	针脚编号分布
<p>M12 锁紧螺纹长度可调节型 焊接</p> <p>适配螺母</p> <p>开孔建议开PG9螺纹孔</p>	FEK32-L	10049002	焊接 105°C 250V 4A	
	FEK42-L	10048992	焊接 105°C 250V 4A	
	FEK52-L	10041028	焊接 105°C 125V 4A	
	FEK62-L	10048994	焊接 105°C 60V 2A	
	FEK82-L	10048995	焊接 105°C 60V 2A	

# 3针/4针/5针/6针/8针M12法兰连接器(可调)

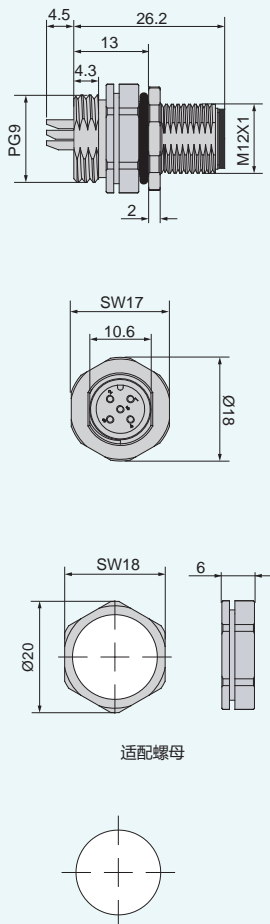

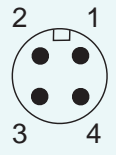
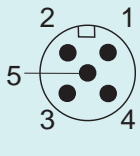
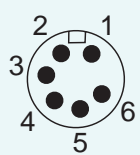
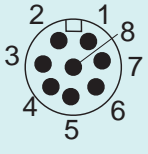
法兰连接器	型号	订货号	特性描述	针脚编号分布
<p>M12 锁紧螺纹长度可调节型 焊接, 针座</p>  <p>适配螺母</p> <p>开孔建议开PG9螺纹孔</p>	FEZ32-L	10049001	焊接 105°C 250V 4A	
	FEZ42-L	10049003	焊接 105°C 250V 4A	
	FEZ52-L	10041029	焊接 105°C 125V 4A	
	FEZ62-L	10048985	焊接 105°C 60V 2A	
	FEZ82-L	10048986	焊接 105°C 60V 2A	

3针/4针/5针/6针/8针M12 法兰连接器(短型)



法兰连接器	型号	订货号	特性描述	针脚编号分布
<p>M12 短型后端锁紧, 焊接 孔座</p>	FEK321-L	10048983	焊接 105°C 250V 4A	
	FEK421-L	10048984	焊接 105°C 250V 4A	
	FEK521-L	10048993	焊接 105°C 125V 4A	
	FEK621-L	10048981	焊接 105°C 60V 2A	
	FEK821-L	10048982	焊接 105°C 60V 2A	

# 3针/4针/5针/6针/8针M12 法兰连接器(短型)



法兰连接器	型号	订货号	特性描述	针脚编号分布
<p>M12 短型后端锁紧, 焊接 针座</p>	FEZ321-L	10048987	焊接 105°C 250V 4A	
	FEZ421-L	10048988	焊接 105°C 250V 4A	
	FEZ521-L	10048989	焊接 105°C 125V 4A	
	FEZ621-L	10048990	焊接 105°C 60V 2A	
	FEZ821-L	10048991	焊接 105°C 60V 2A	



法兰连接器	型号	订货号	特性描述	针脚编号分布
<p>M12 前端锁紧, PCB 孔座</p>	FEK31-P	10041503	3xØ1mm PCB焊接针 105°C 250V 4A	
	FEK41-P	10041513	4xØ1mm PCB焊接针 105°C 250V 4A	
	FEK51-P	10041523	5xØ1mm PCB焊接针 105°C 125V 4A	
	FEK61-P	10041533	6xØ1mm PCB焊接针 105°C 60V 2A	
	FEK81-P	10041553	8xØ1mm PCB焊接针 105°C 60V 2A	

# 3针/4针/5针/6针/8针M12 法兰连接器



法兰连接器	型号	订货号	特性描述	针脚编号分布
<p>M12 前端锁紧, PCB 针座</p>	FEZ31-P	10041603	3xØ1mm PCB焊接针 105°C 250V 4A	
	FEZ41-P	10041613	4xØ1mm PCB焊接针 105°C 250V 4A	
	FEZ51-P	10041623	5xØ1mm PCB焊接针 105°C 125V 4A	
	FEZ61-P	10041643	6xØ1mm PCB焊接针 105°C 60V 2A	
	FEZ81-P	10041653	8xØ1mm PCB焊接针 105°C 60V 2A	



法兰连接器	型号	订货号	特性描述	针脚编号分布
<p>M12 短型后端锁紧, PCB孔座</p>	FEK321-P	10048996	3xØ1mm PCB焊接针 105°C 250V 4A	
	FEK421-P	10048997	4xØ1mm PCB焊接针 105°C 250V 4A	
	FEK521-P	10048998	5xØ1mm PCB焊接针 105°C 125V 4A	
	FEK621-P	10048999	6xØ1mm PCB焊接针 105°C 60V 2A	
	FEK821-P	10049000	8xØ1mm PCB焊接针 105°C 60V 2A	

# 3针/4针/5针/6针/8针M12 法兰连接器(短型)



法兰连接器	型号	订货号	特性描述	针脚编号分布
<p>M12 短型后端锁紧, PCB针座</p>	FEZ321-P	10049004	3xØ1mm PCB焊接针 105°C 250V 4A	
	FEZ421-P	10049005	4xØ1mm PCB焊接针 105°C 250V 4A	
	FEZ521-P	10049006	5xØ1mm PCB焊接针 105°C 125V 4A	
	FEZ621-P	10049007	6xØ1mm PCB焊接针 105°C 60V 2A	
	FEZ821-P	10049008	8xØ1mm PCB焊接针 105°C 60V 2A	



法兰连接器	型号	订货号	特性描述	针脚编号分布
M12 前端锁紧, 出线 孔座 	PT-FEK41-0.5 PT-FEK41-1.0	10093183 10093184	4x1.5mm <sup>2</sup> PVC -40°C ~ +85°C 63VDC 12A 	孔座 
M12 前端锁紧, 出线 针座 	PT-FEZ41-0.5 PT-FEZ41-1.0	10093185 10093186	适配螺母 开孔尺寸	针座 
M12 后端锁紧, 出线 孔座 	PT-FEK42-0.5 PT-FEK42-1.0	10093187 10093188	4x1.5mm <sup>2</sup> PVC -40°C ~ +85°C 63VDC 12A 	孔座 
M12 后端锁紧, 出线 针座 	PT-FEZ42-0.5 PT-FEZ42-1.0	10093189 10093190	适配螺母 开孔尺寸	针座 

# M12电源系列法兰式连接器S-CODE



法兰连接器	型号	订货号	特性描述	针脚编号分布
M12 前端锁紧, 出线 孔座 	PS-FEK41-0.5 PS-FEK41-1.0	10093191 10093192	4x1.5mm <sup>2</sup> PVC 105°C 630VAC 12A 	孔座 1.BK1 2.BK2 3.BK3 4.GN/YE
M12 前端锁紧, 出线 针座 	PS-FEZ41-0.5 PS-FEZ41-1.0	10093193 10093194	适配螺母 开孔尺寸	针座 1.BK1 2.BK2 3.BK3 4.GN/YE
M12 后端锁紧, 出线 孔座 	PS-FEK42-0.5 PS-FEK42-1.0	10093195 10093196	4x1.5mm <sup>2</sup> PVC 105°C 630VAC 12A 	孔座 1.BK1 2.BK2 3.BK3 4.GN/YE
M12 后端锁紧, 出线 针座 	PS-FEZ42-0.5 PS-FEZ42-1.0	10093197 10093198	适配螺母 开孔尺寸	针座 1.BK1 2.BK2 3.BK3 4.GN/YE



法兰连接器	型号	订货号	特性描述	针脚编号分布
<p>M12 前端锁紧, 出线 孔座</p>	PL-FEK51-1.0/M16	10041830	<p>5x1.5mm<sup>2</sup> PVC -30°C ~ +85°C 63VDC 12A</p>	<p>孔座</p> <p>1=BN 2=WH 3=BU 4=BK PE=GY</p>
<p>M12 前端锁紧, 出线 针座</p>	PL-FEZ51-1.0/M16	10041066		<p>针座</p> <p>1=BN 2=WH 3=BU 4=BK PE=GY</p>
<p>M12 后端锁紧, 出线 孔座</p>	PL-FEK52-1.0/M16	10041811	<p>5x1.5mm<sup>2</sup> PVC -30°C ~ +85°C 63VDC 12A</p>	<p>孔座</p> <p>1=BN 2=WH 3=BU 4=BK PE=GY</p>
<p>M12 后端锁紧, 出线 针座</p>	PL-FEZ52-1.0/M16	10041821		<p>针座</p> <p>1=BN 2=WH 3=BU 4=BK PE=GY</p>

# M12电源系列法兰式连接器K-CODE



法兰连接器	型号	订货号	特性描述	针脚编号分布
M12 前端锁紧, 出线 孔座 	PK-FEK51-0.5/M16	10041100	5x1.5mm <sup>2</sup> PVC -30°C ~ +85°C 630VA 12A 	孔座  1=BK1 2=BK2 3=BK3 4=BK4 PE=GN/YE
M12 前端锁紧, 出线 针座 	PK-FEZ51-0.5/M16	10041101		针座  1=BK1 2=BK2 3=BK3 4=BK4 PE=GN/YE
M12 后端锁紧, 出线 孔座 	PK-FEK52-2.0/M16	10256140	5x1.5mm <sup>2</sup> PVC -30°C ~ +85°C 630VA 12A 	孔座  1=BK1 2=BK2 3=BK3 4=BK4 PE=GN/YE
M12 后端锁紧, 出线 针座 	PK-FEZ52-1.0/M16	10041823		针座  1=BK1 2=BK2 3=BK3 4=BK4 PE=GN/YE

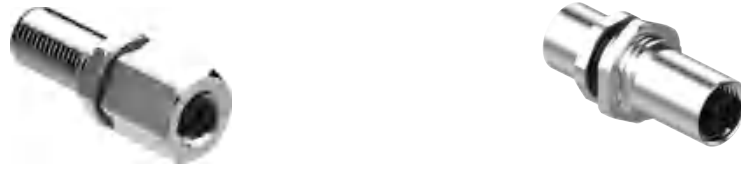

法兰连接器	型号	订货号	特性描述	引脚编号分布
<p>M12 转换接头</p> <p>A-Code</p> <p>B-Code</p> <p>D-Code</p> <p>开孔尺寸 <math>\phi 12.2</math></p>	FEK4 FEZ4/M12	10041700	4芯 公-母 105°C 250V 4A	
	FEK5 FEZ5/M12	10041024	5芯 公-母 105°C 250V 4A	
	FEK6 FEZ6/M12	10041702	6芯 公-母 105°C 60V 1.5A	
	FEK8 FEZ8/M12	10041554	8芯 公-母 105°C 60V 1.5A	
	FEBK5 FEBZ5/M12	10041703	5芯 公-母 B-code 105°C 250V 4A	
	FEIK4 FEIZ4/M12	10041662	4芯 公-母 D-code 105°C 250V 4A	
	<p>开孔尺寸</p>	FEIK4 FEIK4/M16	10041779	4芯 母-母 D-code 105°C 60 AC /DC 4A

# M12 T型头



预铸式连接器	型号	订货号	接线图
<p>M12 T型头电源连接器 5芯</p> 	<p>TEZ5-2EK5 TEZ5-2EK5/HBU TEZ5-2EK5/HGN</p>	<p>10082104 10082108 10082109</p>	

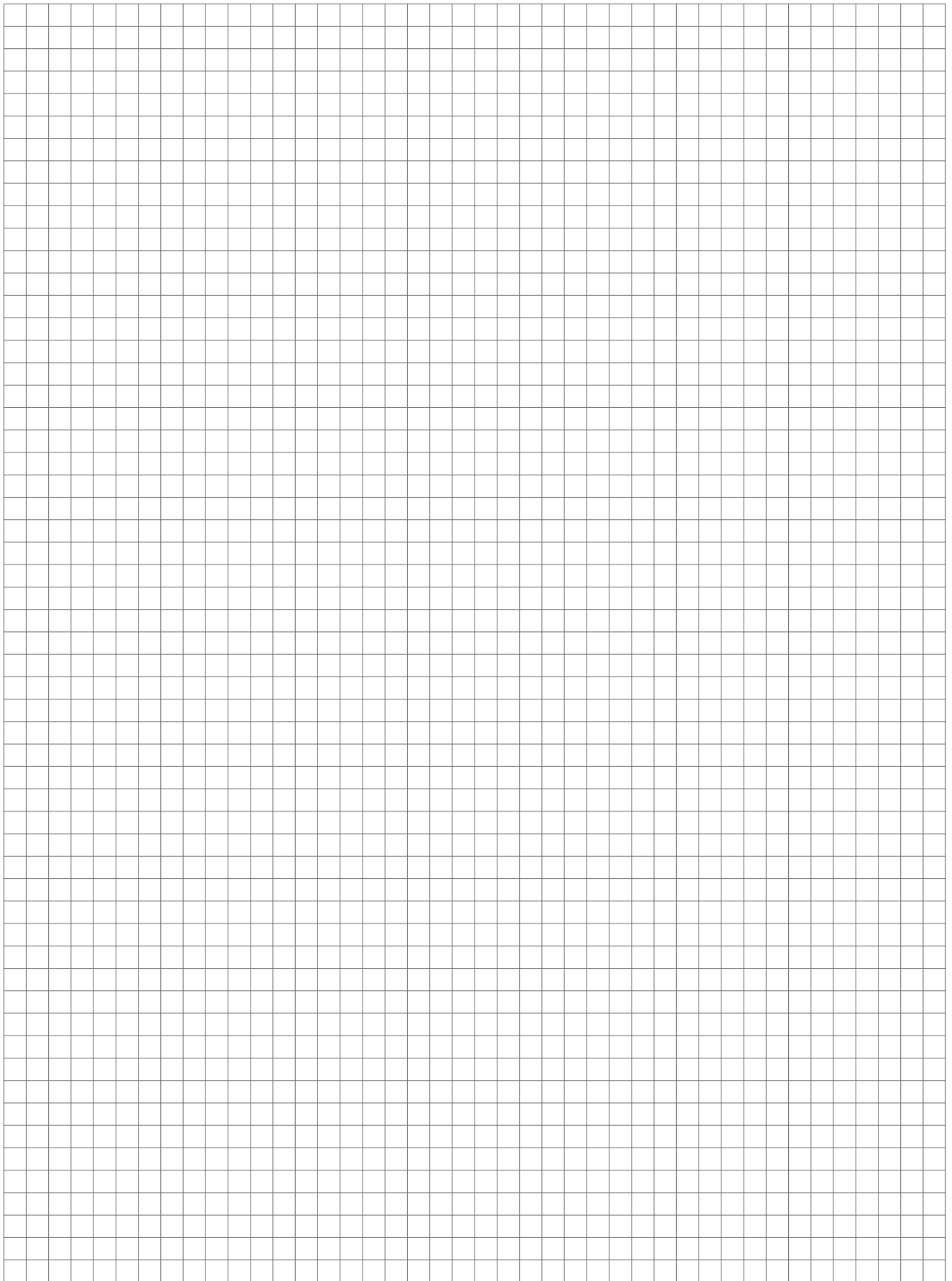



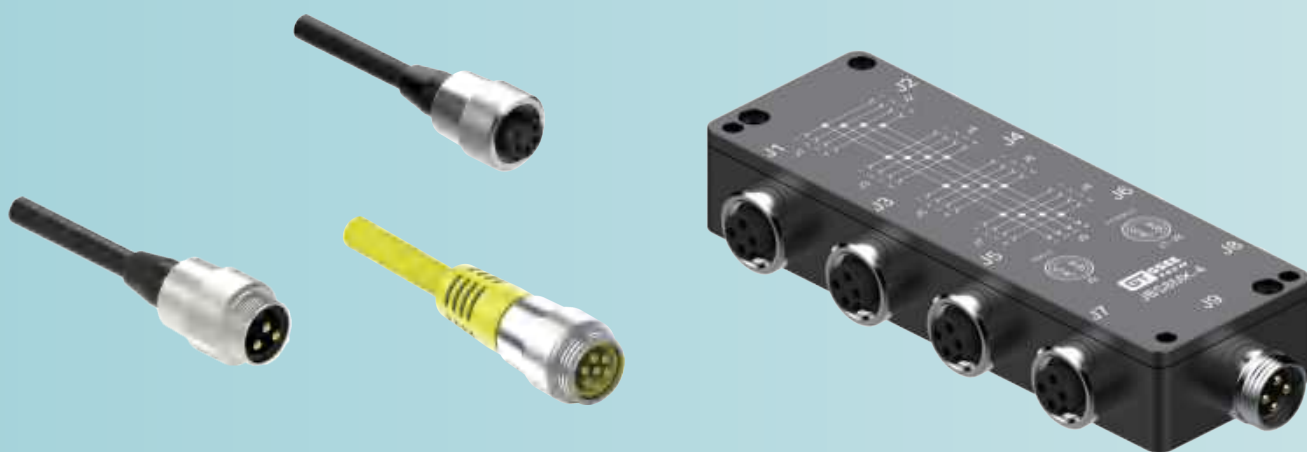

## ■ 7/8" 工业连接器

## 7/8"预铸式连接器型号命名规则

### 预铸连接器命名规则

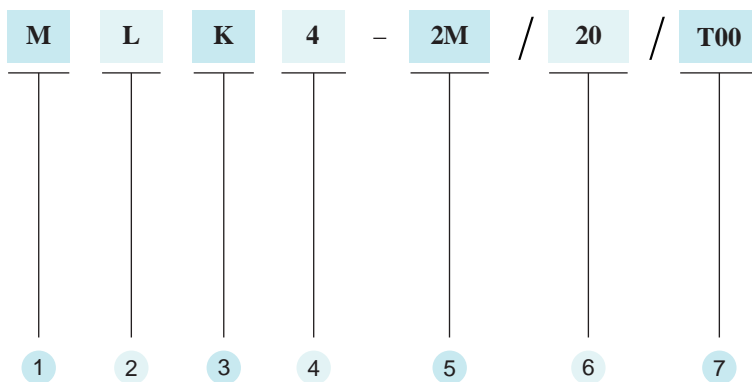

1 M 7/8"-16UN 连接器

2 Blank 直线型  
L 直角型

3 K 孔座  
Z 针座

4 针脚数  
编号分配

5 线缆长度[m]

6 线缆及预铸接头代码

Blank 黑色PVC,16AWG,黑色预铸头  
20 黄色PVC,16AWG,黄色预铸头  
22 灰色PVC,16AWG,黑色预铸头  
24 黄色高柔拖链PUR,16AWG,黄色预铸头  
25 灰色PVC,16AWG,灰色预铸头  
47 黑色PVC,16AWG,蓝色预铸接头  
48 黑色拖链PUR,16AWG,蓝色预铸头  
49 黑色拖链PUR,16AWG,黑色预铸头  
52 灰色高柔拖链PUR,16AWG,黑色预铸头  
57 灰色PVC,16AWG,蓝色预铸头

P314 黄色拖链PUR,14AWG,黄色预铸头  
P324 黄色PVC,14AWG,黄色预铸头  
P514 黑色拖链PUR,14AWG,黑色预铸头  
P524 黑色PVC,14AWG,黑色预铸头

7 特殊规格定制

### 双端预铸连接器型号说明

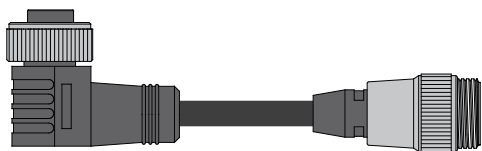

MLK5 MZ5-2M

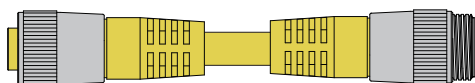

MK4 MZ4-2M/20

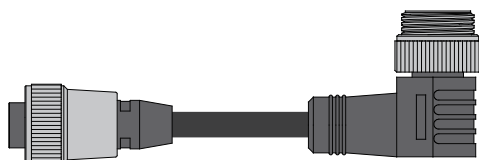

MK4 MLZ4-2M

法兰连接器命名规则

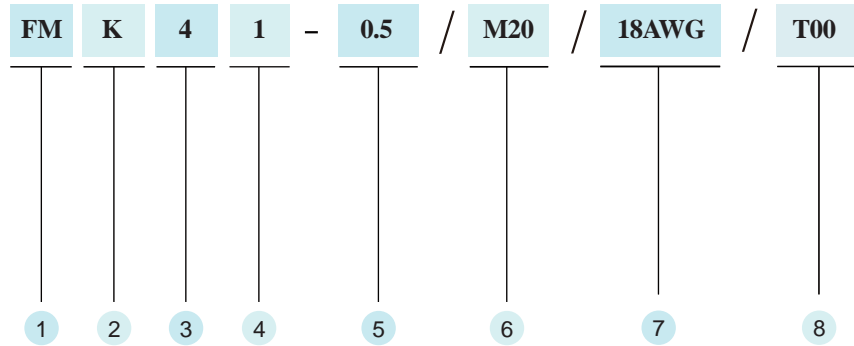

1 FM 7/8'-16UN 法兰连接器

2 K 孔座  
Z 针座

3 针脚数  
编号分配

4 连接方式  
1 前端拧紧型  
2 后端拧紧型

5 0.5 尾线长度 0.5m  
L 导线焊接触点  
P PCB焊接触点

6 连接螺纹规格  
PG13.5 13.5  
M20 M20X1.5  
M30 M30X1.5  
NPT 1/2-14  
NPSM 1/2-14

7 线规  
Blank 16AWG 标准线规  
18AWG

8 特殊规格定制

现场可接线连接器命名规则

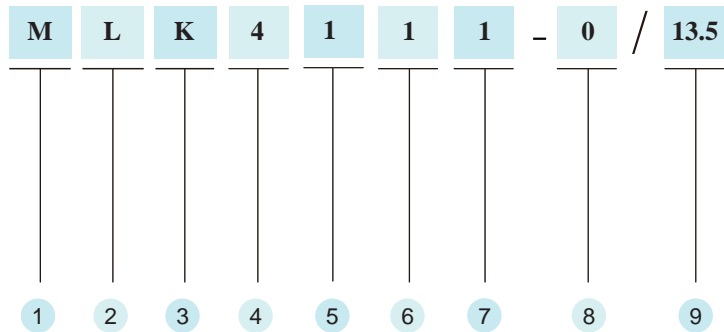

1 M 7/8'-16UN 现场可接线连接器

2 L 直角型  
Blank 直线型

3 K 孔座  
Z 针座

4 针脚数  
编号分配

5 触点材质  
1 铜合金镀银  
2 铜合金镀金

6 1 A-code

7 外壳材质  
0 塑料外壳尼龙锁头  
1 塑料外壳铸铝锁头  
2 塑料外壳不锈钢锁头

8 后端连接方式  
0:单输出口  
1:双输出口

9 电缆接口  
9 PG9(锁紧电缆外径范围4~6mm)  
11 PG11(锁紧电缆外径范围8~10mm)  
13.5 PG13.5(锁紧电缆外径范围10~12mm)

连接方式 Blank 螺钉连接

## 3针7/8"预铸式连接器

- 预铸接头:TPU材质,黑色
- 锁紧螺母:黄铜镀镍
- 针托:TPU材质,黑色
- 触点:黄铜镀金
- 防护等级:IP67
- 电流等级:9A
- 电压等级:600V
- 绝缘电阻: $\geq 10^9 \Omega$
- 接触电阻: $\leq 5m\Omega$
- 污染等级:3
- 使用环境温度: $-40 \sim +80^\circ\text{C}$
- 可插拔寿命:最小100次
- 电缆最大外径: 8mm



预铸式连接器	型号	订货号	电缆	针脚编号分布
直线孔座MK..** 	MK3-2M MK3-5M MK3-10M	10035000 10035008 10035009	黑色PVC电缆 3x16AWG (3x1.5mm <sup>2</sup> ) Ø8.0mm 电缆型号: 58104911-*M	孔座 
直角孔座MLK..** 	MLK3-2M MLK3-5M MLK3-10M	10035010 10035011 10035012		1.GN/YE 2.BN 3.BU
直线针座MZ..** 	MZ3-2M MZ3-5M MZ3-10M	10035020 10032077 10035023	黑色PVC电缆 3x16AWG (3x1.5mm <sup>2</sup> ) Ø8.0mm 电缆型号: 58104911-*M	针座 
直角针座MLZ..** 	MLZ3-2M MLZ3-5M MLZ3-10M	10035030 10035032 10035036		1.GN/YE 2.BN 3.BU

\* 标准长度为2/5/10米,可订制任意长度

\*\* 标准锁紧螺母材质为黄铜镀镍

## 4针7/8"预铸式连接器

- 预铸接头:TPU材质
- 锁紧螺母:黄铜镀镍
- 针托:TPU材质,黑色
- 触点:黄铜镀金
- 防护等级:IP67
- 电流等级:9A
- 电压等级:600V
- 绝缘电阻: $\geq 10^9 \Omega$
- 接触电阻: $\leq 5m\Omega$
- 污染等级:3
- 使用环境温度:-40~+80°C
- 可插拔寿命:最小100次



预铸式连接器	型号	订货号	电缆	针脚编号分布
<b>直线孔座MK..**</b> 	MK4-2M MK4-5M MK4-10M	10032000 10032001 10032008	黑色PVC电缆 4x16AWG Ø8.0mm 电缆型号: 58315351-*M	<p>孔座</p>
<b>直角孔座MLK..**</b> 	MLK4-2M MLK4-5M MLK4-10M	10032010 10032023 10032024	黑色PVC电缆 4x16AWG Ø8.0mm 电缆型号: 58315351-*M	<p>1.RD 2.GN 3.WH 4.BK</p>
<b>直线针座MZ..**</b> 	MZ4-2M MZ4-5M MZ4-10M	10032020 10032082 10032025	黑色PVC电缆 4x16AWG (4x1.5mm <sup>2</sup> ) Ø8.0mm 电缆型号: 58315351-*M	<p>针座</p>
<b>直角针座MLZ..**</b> 	MLZ4-2M MLZ4-5M MLZ4-10M	10032030 10032032 10032033	黑色PVC电缆 4x16AWG (4x1.5mm <sup>2</sup> ) Ø8.0mm 电缆型号: 58315351-*M	<p>1.RD 2.GN 3.WH 4.BK</p>
<b>直线孔座MK..**</b> 	MK4-2M/20 MK4-5M/20 MK4-10M/20	10032500 10032501 10036002	黄色PVC电缆 4x16AWG (4x1.5mm <sup>2</sup> ) Ø11mm 电缆型号: 58301352-*M	<p>孔座</p>
<b>直角孔座MLK..**</b> 	MLK4-2M/20 MLK4-5M/20 MLK4-10M/20	10032520 10032028 10032029	黄色PVC电缆 4x16AWG (4x1.5mm <sup>2</sup> ) Ø11mm 电缆型号: 58301352-*M	<p>1.BK 2.WH 3.RD 4.GN</p>
<b>直线针座MZ..**</b> 	MZ4-2M/20 MZ4-5M/20 MZ4-10M/20	10032510 10032522 10032523	黄色PVC电缆 4x16AWG (4x1.5mm <sup>2</sup> ) Ø11mm 电缆型号: 58301352-*M	<p>针座</p>
<b>直角针座MLZ..**</b> 	MLZ4-2M/20 MLZ4-5M/20 MLZ4-10M/20	10032530 10032034 10032035	黄色PVC电缆 4x16AWG (4x1.5mm <sup>2</sup> ) Ø11mm 电缆型号: 58301352-*M	<p>1.BK 2.WH 3.RD 4.GN</p>

\* 标准长度为2/5/10米,可订制任意长度

\*\* 标准锁紧螺母材质为黄铜镀镍

## 5针7/8"预铸式连接器

- 预铸接头:TPU材质
- 锁紧螺母:黄铜镀镍
- 针托:TPU材质,黑色
- 触点:黄铜镀金
- 防护等级:IP67
- 电流等级:9A
- 电压等级:600V
- 绝缘电阻: $\geq 10^9 \Omega$
- 绝缘电阻: $\leq 5m\Omega$
- 污染等级:3
- 使用环境温度:-40~+80°C
- 可插拔寿命:最小100次
- 电缆最大外径: 8.6mm



预铸式连接器	型号	订货号	电缆	针脚编号分布
直线孔座MK..** 	MK5-2M MK5-5M MK5-10M	10033000 10033001 10033002	黑色PVC电缆 5x16AWG (5x1.5mm <sup>2</sup> ) Ø8.6mm 电缆型号: 58118911-*M	孔座 
直角孔座MLK..** 	MLK5-2M MLK5-5M MLK5-10M	10033010 10033524 10033090		1.BK 2.BU 3.GNYE 4.BN 5.WH
直线针座MZ..** 	MZ5-2M MZ5-5M MZ5-10M	10033020 10032521 10033022	黑色PVC电缆 5x16AWG (5x1.5mm <sup>2</sup> ) Ø8.6mm 电缆型号: 58118911-*M	针座 
直角针座MLZ..** 	MLZ5-2M MLZ5-5M MLZ5-10M	10033030 10035066 10033116		1.BK 2.BU 3.GNYE 4.BN 5.WH

\* 标准长度为2/5/10米,可订制任意长度

\*\* 标准锁紧螺母材质为黄铜镀镍

## 6针7/8"预铸式连接器

- 预铸接头:TPU材质
- 锁紧螺母:黄铜镀镍
- 针托:TPU材质,黄色
- 触点:黄铜镀金
- 防护等级:IP67
- 电流等级:9A
- 电压等级:600V
- 绝缘电阻: $\geq 10^9 \Omega$
- 接触电阻: $\leq 5m\Omega$
- 污染等级:3
- 使用环境温度: $-40 \sim +80^\circ\text{C}$
- 可插拔寿命:最小100次
- 电缆最大外径: 15mm



预铸式连接器	型号	订货号	电缆	针脚编号分布
<b>直线孔座MK..**</b> 	MK6-2M MK6-5M MK6-10M	10093199 10093200 10093201	黑色PVC电缆 6x16AWG (6x1.5mm <sup>2</sup> ) Ø13.6mm 电缆型号: 58035151-*M	 孔座
<b>直角孔座MLK..**</b> 	MLK6-2M MLK6-5M MLK6-10M	10093202 10093203 10093204	黑色PVC电缆 6x16AWG (6x1.5mm <sup>2</sup> ) Ø13.6mm 电缆型号: 58035151-*M	 1.WH 2.RD 3.GN 4.OR 5.BK 6.BU
<b>直线针座MZ..**</b> 	MZ6-2M MZ6-5M MZ6-10M	10093205 10032183 10093206	黑色PVC电缆 6x16AWG (6x1.5mm <sup>2</sup> ) Ø13.6mm 电缆型号: 58035151-*M	 针座
<b>直角针座MLZ..**</b> 	MLZ6-2M MLZ6-5M MLZ6-10M	10093207 10093208 10093209	黑色PVC电缆 6x16AWG (6x1.5mm <sup>2</sup> ) Ø13.6mm 电缆型号: 58035151-*M	 1.WH 2.RD 3.GN 4.OR 5.BK 6.BU
<b>直线孔座MK..**</b> 	MK6-2M/20 MK6-5M/20 MK6-10M/20	10093210 10093211 10093212	黄色PVC电缆 6x16AWG (6x1.5mm <sup>2</sup> ) Ø13.6mm 电缆型号: 58036151-*M	 孔座
<b>直角孔座MLK..**</b> 	MLK6-2M/20 MLK6-5M/20 MLK6-10M/20	10093213 10093214 10093215	黄色PVC电缆 6x16AWG (6x1.5mm <sup>2</sup> ) Ø13.6mm 电缆型号: 58036151-*M	 1.WH 2.RD 3.GN 4.OR 5.BK 6.BU
<b>直线针座MZ..**</b> 	MZ6-2M/20 MZ6-5M/20 MZ6-10M/20	10093216 10093217 10093218	黄色PVC电缆 6x16AWG (6x1.5mm <sup>2</sup> ) Ø13.6mm 电缆型号: 58036151-*M	 针座
<b>直角针座MLZ..**</b> 	MLZ6-2M/20 MLZ6-5M/20 MLZ6-10M/20	10093219 10093220 10093221	黄色PVC电缆 6x16AWG (6x1.5mm <sup>2</sup> ) Ø13.6mm 电缆型号: 58036151-*M	 1.WH 2.RD 3.GN 4.OR 5.BK 6.BU

\* 标准长度为2/5/10米,可订制任意长度

\*\* 标准锁紧螺母材质为黄铜镀镍

# 7/8" T型头电源连接器



预铸式连接器	型号	订货号	接线图
<p>7/8" T型头电源连接器 3芯</p>	<p>MZ3-2MK3 MZ3-2MK3/HBU MZ3-2MK3/HYE</p>	<p>10035120 10035119 10033027</p>	
<p>7/8" T型头电源连接器 4芯</p>	<p>MZ4-2MK4 MZ4-2MK4/HBU MZ4-2MK4/HYE</p>	<p>10083000 10082999 10084002</p>	
<p>7/8" T型头电源连接器 5芯</p>	<p>MZ5-2MK5 MZ5-2MK5/HBU MZ5-2MK5/HYE</p>	<p>10084000 10084004 10084001</p>	
<p>7/8" T型头电源连接器 5芯</p>	<p>MWZ5-2MK5 MWZ5-2MK5/HBU MWZ5-2MK5/HYE</p>	<p>10021476</p>	

\* 标准长度为2/5/10米,可订制任意长度

\*\* 标准锁紧螺母材质为黄铜镀镍



现场可接线连接器	型号	订货号	特性描述	针脚编号分布
7/8" 直线孔座 - 螺钉连接	MK3211-0/9	10092334	尼龙+玻璃纤维黑色 铸铝螺母 PG9电缆出线口 可连接的电缆外径范围: 6-8mm 插孔尾部可连接的最大线:2.5mm <sup>2</sup> 螺钉连接 85°C,250V,12 A	
	MK3211-0/11	10092330	尼龙+玻璃纤维黑色 铸铝螺母 PG11电缆出线口 可连接的电缆外径范围: 8-10mm 插孔尾部可连接的最大线:2.5mm <sup>2</sup> 螺钉连接 85°C,250V,12 A	
	MK3211-0/13.5	10255320	尼龙+玻璃纤维黑色 铸铝螺母 PG13.5电缆出线口 可连接的电缆外径范围: 10-12mm 插孔尾部可连接的最大线:2.5mm <sup>2</sup> 螺钉连接 85°C,250V,12 A	
	MK4211-0/9	10092010	尼龙+玻璃纤维黑色 铸铝螺母 PG9电缆出线口 可连接的电缆外径范围: 6-8mm 插孔尾部可连接的最大线:2.5mm <sup>2</sup> 螺钉连接 85°C,250V,9 A	
	MK4211-0/11	10092003	尼龙+玻璃纤维黑色 铸铝螺母 PG11电缆出线口 可连接的电缆外径范围: 8-10mm 插孔尾部可连接的最大线:2.5mm <sup>2</sup> 螺钉连接 85°C,250V,9 A	
	MK4211-0/13.5	10092202	尼龙+玻璃纤维黑色 铸铝螺母 PG13.5电缆出线口 可连接的电缆外径范围: 10-12mm 插孔尾部可连接的最大线:2.5mm <sup>2</sup> 螺钉连接 85°C,250V,9 A	
	MK5211-0/9	10092303	尼龙+玻璃纤维黑色 铸铝螺母 PG9电缆出线口 可连接的电缆外径范围: 6-8mm 插孔尾部可连接的最大线:2.5mm <sup>2</sup> 螺钉连接 85°C,250V,9 A	
	MK5211-0/11	10092004	尼龙+玻璃纤维黑色 铸铝螺母 PG11电缆出线口 可连接的电缆外径范围: 8-10mm 插孔尾部可连接的最大线:2.5mm <sup>2</sup> 螺钉连接 85°C,250V,9 A	
	MK5211-0/13.5	10092302	尼龙+玻璃纤维黑色 铸铝螺母 PG13.5电缆出线口 可连接的电缆外径范围: 10-12mm 插孔尾部可连接的最大线:2.5mm <sup>2</sup> 螺钉连接 85°C,250V,9 A	

## 3针/4针/5针7/8"现场可接线连接器



现场可接线连接器	型号	订货号	特性描述	针脚编号分布
7/8" 直线针座 - 螺钉连接  	MZ3211-0/9	10092329	尼龙+玻璃纤维黑色 铸铝螺母 PG9电缆出线口 可连接的电缆外径范围:6-8mm 插针尾部可连接的最大线:2.5mm <sup>2</sup> 螺钉连接 85°C,250V,12 A	
	MZ3211-0/11	10092328	尼龙+玻璃纤维黑色 铸铝螺母 PG11电缆出线口 可连接的电缆外径范围: 8-10mm 插针尾部可连接的最大线:2.5mm <sup>2</sup> 螺钉连接 85°C,250V,12 A	
	MZ3211-0/13.5	10092325	尼龙+玻璃纤维黑色 铸铝螺母 PG13.5电缆出线口 可连接的电缆外径范围: 10-12mm 插针尾部可连接的最大线:2.5mm <sup>2</sup> 螺钉连接 85°C,250V,12 A	
	MZ4211-0/9	10092019	尼龙+玻璃纤维黑色 铸铝螺母 PG9电缆出线口 可连接的电缆外径范围: 6-8mm 插针尾部可连接的最大线:2.5mm <sup>2</sup> 螺钉连接 85°C,250V,9 A	
	MZ4211-0/11	10092005	尼龙+玻璃纤维黑色 铸铝螺母 PG11电缆出线口 可连接的电缆外径范围: 8-10mm 插针尾部可连接的最大线:2.5mm <sup>2</sup> 螺钉连接 85°C,250V,9 A	
	MZ4211-0/13.5	10092222	尼龙+玻璃纤维黑色 铸铝螺母 PG13.5电缆出线口 可连接的电缆外径范围: 10-12mm 插针尾部可连接的最大线:2.5mm <sup>2</sup> 螺钉连接 85°C,250V,9 A	
	MZ5211-0/9	10092011	尼龙+玻璃纤维黑色 铸铝螺母 PG9电缆出线口 可连接的电缆外径范围: 6-8mm 插针尾部可连接的最大线:2.5mm <sup>2</sup> 螺钉连接 85°C,250V,9 A	
	MZ5211-0/11	10092006	尼龙+玻璃纤维黑色 铸铝螺母 PG11电缆出线口 可连接的电缆外径范围: 8-10mm 插针尾部可连接的最大线:2.5mm <sup>2</sup> 螺钉连接 85°C,250V,9 A	
	MZ5211-0/13.5	10092322	尼龙+玻璃纤维黑色 铸铝螺母 PG13.5电缆出线口 可连接的电缆外径范围: 10-12mm 插针尾部可连接的最大线:2.5mm <sup>2</sup> 螺钉连接 85°C,250V,9 A	

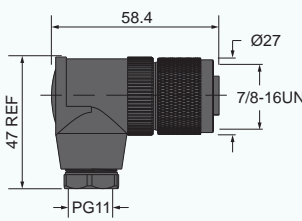
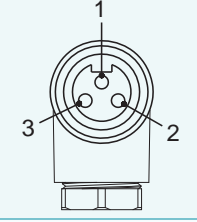
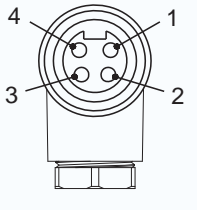
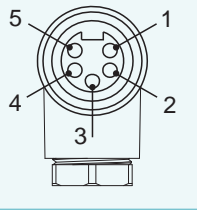
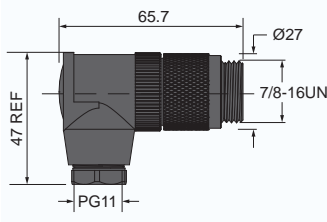
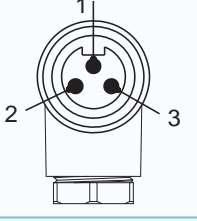
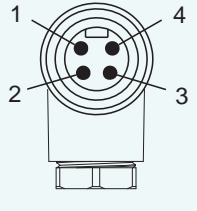
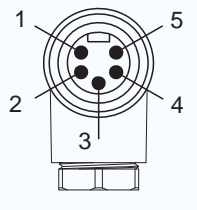

现场可接线连接器	型号	订货号	特性描述	针脚编号分布
7/8" 直角孔座 - 螺钉连接  	MLK3211-0/11	10255321	尼龙+玻璃纤维黑色 PG11电缆出线口 可连接的电缆外径范围: 8-10mm 插孔尾部可连接的最大线:2.5mm <sup>2</sup> 螺钉连接 85°C,250V,12 A	
	MLK4211-0/11	10092320	尼龙+玻璃纤维黑色 PG11电缆出线口 可连接的电缆外径范围: 8-10mm 插孔尾部可连接的最大线:2.5mm <sup>2</sup> 螺钉连接 85°C,250V,9 A	
	MLK5211-0/11	10092009	尼龙+玻璃纤维黑色 PG11电缆出线口 可连接的电缆外径范围: 8-10mm 插孔尾部可连接的最大线:2.5mm <sup>2</sup> 螺钉连接 85°C,250V,9 A	
7/8" 直角针座 - 螺钉连接  	MLZ3211-0/11	10092344	尼龙+玻璃纤维黑色 PG11电缆出线口 可连接的电缆外径范围: 8-10mm 插针尾部可连接的最大线:2.5mm <sup>2</sup> 螺钉连接 85°C,250V,12 A	
	MLZ4211-0/11	10092321	尼龙+玻璃纤维黑色 PG11电缆出线口 可连接的电缆外径范围: 8-10mm 插针尾部可连接的最大线:2.5mm <sup>2</sup> 螺钉连接 85°C,250V,9 A	
	MLZ5211-0/11	10092224	尼龙+玻璃纤维黑色 PG11电缆出线口 可连接的电缆外径范围: 8-10mm 插针尾部可连接的最大线:2.5mm <sup>2</sup> 螺钉连接 85°C,250V,9 A	

## 3针/4针/5针7/8"现场可接线连接器



现场可接线连接器	型号	订货号	特性描述	针脚编号分布
7/8" 直线孔座 - 螺钉连接  	MK3212-0/9	10092013	尼龙+玻璃纤维黑色 不锈钢螺母 PG9电缆出线口 可连接的电缆外径范围: 6-8mm 插孔尾部可连接的最大线: 2.5mm <sup>2</sup> 螺钉连接 85°C, 250V, 12 A	
	MK3212-0/11	10092014	尼龙+玻璃纤维黑色 不锈钢螺母 PG11电缆出线口 可连接的电缆外径范围: 8-10mm 插孔尾部可连接的最大线: 2.5mm <sup>2</sup> 螺钉连接 85°C, 250V, 12 A	
	MK3212-0/13.5	10255322	尼龙+玻璃纤维黑色 不锈钢螺母 PG13.5电缆出线口 可连接的电缆外径范围: 10-12mm 插孔尾部可连接的最大线: 2.5mm <sup>2</sup> 螺钉连接 85°C, 250V, 12 A	
	MK4212-0/9	10092018	尼龙+玻璃纤维黑色 不锈钢螺母 PG9电缆出线口 可连接的电缆外径范围: 6-8mm 插孔尾部可连接的最大线: 2.5mm <sup>2</sup> 螺钉连接 85°C, 250V, 9 A	
	MK4212-0/11	10092017	尼龙+玻璃纤维黑色 不锈钢螺母 PG11电缆出线口 可连接的电缆外径范围: 8-10mm 插孔尾部可连接的最大线: 2.5mm <sup>2</sup> 螺钉连接 85°C, 250V, 9 A	
	MK4212-0/13.5	10092012	尼龙+玻璃纤维黑色 不锈钢螺母 PG13.5电缆出线口 可连接的电缆外径范围: 10-12mm 插孔尾部可连接的最大线: 2.5mm <sup>2</sup> 螺钉连接 85°C, 250V, 9 A	
	MK5212-0/9	10092319	尼龙+玻璃纤维黑色 不锈钢螺母 PG9电缆出线口 可连接的电缆外径范围: 6-8mm 插孔尾部可连接的最大线: 2.5mm <sup>2</sup> 螺钉连接 85°C, 250V, 9 A	
	MK5212-0/11	10092318	尼龙+玻璃纤维黑色 不锈钢螺母 PG11电缆出线口 可连接的电缆外径范围: 8-10mm 插孔尾部可连接的最大线: 2.5mm <sup>2</sup> 螺钉连接 85°C, 250V, 9 A	
	MK5212-0/13.5	10092323	尼龙+玻璃纤维黑色 不锈钢螺母 PG13.5电缆出线口 可连接的电缆外径范围: 10-12mm 插孔尾部可连接的最大线: 2.5mm <sup>2</sup> 螺钉连接 85°C, 250V, 9 A	



现场可接线连接器	型号	订货号	特性描述	针脚编号分布
7/8" 直线针座 - 螺钉连接  	MZ3212-0/9	10255323	尼龙+玻璃纤维黑色 不锈钢螺母 PG9电缆出线 可连接的电缆外径范围: 6-8mm 插针尾部可连接的最大线:2.5mm <sup>2</sup> 螺钉连接 85°C,250V,12 A	
	MZ3212-0/11	10092015	尼龙+玻璃纤维黑色 不锈钢螺母 PG11电缆出线口 可连接的电缆外径范围: 8-10mm 插针尾部可连接的最大线:2.5mm <sup>2</sup> 螺钉连接 85°C,250V,12 A	
	MZ3212-0/13.5	10255324	尼龙+玻璃纤维黑色 不锈钢螺母 PG13.5电缆出线口 可连接的电缆外径范围: 10-12mm 插针尾部可连接的最大线:2.5mm <sup>2</sup> 螺钉连接 85°C,250V,12 A	
	MZ4212-0/9	10092317	尼龙+玻璃纤维黑色 不锈钢螺母 PG9电缆出线口 可连接的电缆外径范围: 6-8mm 插针尾部可连接的最大线:2.5mm <sup>2</sup> 螺钉连接 85°C,250V,9 A	
	MZ4212-0/11	10092316	尼龙+玻璃纤维黑色 不锈钢螺母 PG11电缆出线口 可连接的电缆外径范围: 8-10mm 插针尾部可连接的最大线:2.5mm <sup>2</sup> 螺钉连接 85°C,250V,9 A	
	MZ4212-0/13.5	10092008	尼龙+玻璃纤维黑色 不锈钢螺母 PG13.5电缆出线口 可连接的电缆外径范围: 10-12mm 插针尾部可连接的最大线:2.5mm <sup>2</sup> 螺钉连接 85°C,250V,9 A	
	MZ5212-0/9	10092310	尼龙+玻璃纤维黑色 不锈钢螺母 PG9电缆出线口 可连接的电缆外径范围: 6-8mm 插针尾部可连接的最大线:2.5mm <sup>2</sup> 螺钉连接 85°C,250V,9 A	
	MZ5212-0/11	10092311	尼龙+玻璃纤维黑色 不锈钢螺母 PG11电缆出线口 可连接的电缆外径范围: 8-10mm 插针尾部可连接的最大线:2.5mm <sup>2</sup> 螺钉连接 85°C,250V,9 A	
	MZ5212-0/13.5	10092324	尼龙+玻璃纤维黑色 不锈钢螺母 PG13.5电缆出线口 可连接的电缆外径范围: 10-12mm 插针尾部可连接的最大线:2.5mm <sup>2</sup> 螺钉连接 85°C,250V,9 A	

## 3针/4针/5针7/8"现场可接线连接器

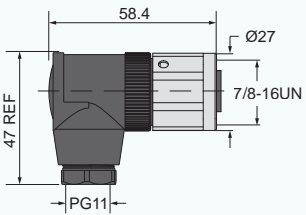
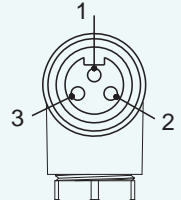
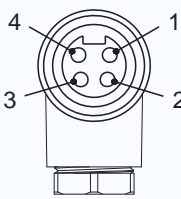
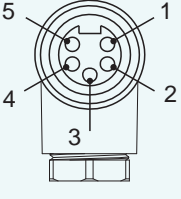
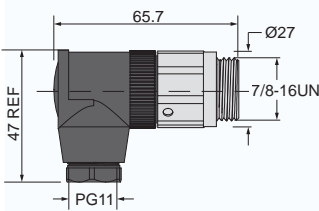
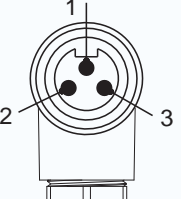
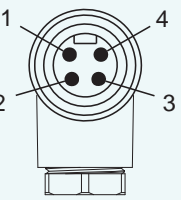
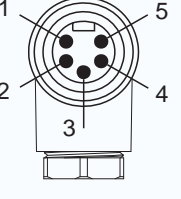

现场可接线连接器	型号	订货号	特性描述	针脚编号分布
7/8" 直角孔座 - 螺钉连接  	MLK3212-0/11	10255325	尼龙+玻璃纤维黑色 不锈钢螺母 PG11电缆出线口 可连接的电缆外径范围: 8-10mm 插孔尾部可连接的最大线: 2.5mm <sup>2</sup> 螺钉连接 85°C, 250V, 9 A	
	MLK4212-0/11	10092312	尼龙+玻璃纤维黑色 不锈钢螺母 PG11电缆出线口 可连接的电缆外径范围: 8-10mm 插孔尾部可连接的最大线: 2.5mm <sup>2</sup> 螺钉连接 85°C, 250V, 9 A	
	MLK5212-0/11	10092313	尼龙+玻璃纤维黑色 不锈钢螺母 PG11电缆出线口 可连接的电缆外径范围: 8-10mm 插孔尾部可连接的最大线: 2.5mm <sup>2</sup> 螺钉连接 85°C, 250V, 9 A	
7/8" 直角针座 - 螺钉连接  	MLZ3212-0/11	10255326	尼龙+玻璃纤维黑色 不锈钢螺母 PG11电缆出线口 可连接的电缆外径范围: 8-10mm 插针尾部可连接的最大线: 2.5mm <sup>2</sup> 螺钉连接 85°C, 250V, 9 A	
	MLZ4212-0/11	10092314	尼龙+玻璃纤维黑色 不锈钢螺母 PG11电缆出线口 可连接的电缆外径范围: 8-10mm 插针尾部可连接的最大线: 2.5mm <sup>2</sup> 螺钉连接 85°C, 250V, 9 A	
	MLZ5212-0/11	10092315	尼龙+玻璃纤维黑色 不锈钢螺母 PG11电缆出线口 可连接的电缆外径范围: 8-10mm 插针尾部可连接的最大线: 2.5mm <sup>2</sup> 螺钉连接 85°C, 250V, 9 A	



法兰连接器	型号	订货号	特性描述	针脚编号分布
<p>7/8" 后端锁紧, 出线孔座</p> <p>后部尺寸</p> <p>开孔尺寸</p>	FMK32-0.5/M20	10042126	3x16AWG(3x1.5mm <sup>2</sup> ) PVC 105°C 600V 9A	
	FMK32-1.0/M20	10042136		
	FMK42-0.5/M20	10042000	4x16AWG(4x1.5mm <sup>2</sup> ) PVC 105°C 600V 9A	
	FMK42-1.0/M20	10042002		
	FMK52-0.5/M20	10042010	5x16AWG(5x1.5mm <sup>2</sup> ) PVC 105°C 600V 9A	
	FMK52-1.0/M20	10042021		
<p>7/8" 后端锁紧, 出线针座</p> <p>后部尺寸</p> <p>开孔尺寸</p>	FMZ32-0.5/M20	10046150	3x16AWG(3x1.5mm <sup>2</sup> ) PVC 105°C 600V 9A	
	FMZ32-1.0/M20	10046162		
	FMZ42-0.5/M20	10042100	4x16AWG(4x1.5mm <sup>2</sup> ) PVC 105°C 600V 9A	
	FMZ42-1.0/M20	10046158		
	FMZ52-0.5/M20	10042110	5x16AWG(5x1.5mm <sup>2</sup> ) PVC 105°C 600V 9A	
	FMZ52-1.0/M20	10042031		

# 6针7/8"法兰连接器



法兰连接器	型号	订货号	特性描述	针脚编号分布
<p>7/8" 后端锁紧, 出线孔座</p> <p>后部尺寸</p> <p>开孔尺寸</p>	<p>FMK62-0.5/M20</p> <p>FMK62-1.0/M20</p>	<p>10041169</p> <p>10041170</p>	<p>6x16AWG(6x1.5mm<sup>2</sup>)</p> <p>PVC</p> <p>105°C</p> <p>600V</p> <p>9A</p>	<p>1.WH</p> <p>2.RD</p> <p>3.GN</p> <p>4.OR</p> <p>5.BK</p> <p>6.BU</p>
<p>7/8" 后端锁紧, 出线针座</p> <p>后部尺寸</p> <p>开孔尺寸</p>	<p>FMZ62-0.5/M20</p> <p>FMZ62-1.0/M20</p>	<p>10041171</p> <p>10041172</p>	<p>6x16AWG(6x1.5mm<sup>2</sup>)</p> <p>PVC</p> <p>105°C</p> <p>600V</p> <p>9A</p>	<p>1.WH</p> <p>2.RD</p> <p>3.GN</p> <p>4.OR</p> <p>5.BK</p> <p>6.BU</p>

## 3针/4针5针/6针7/8' 前锁紧法兰连接器



法兰连接器	型号	订货号	特性描述	针脚编号分布
<p>7/8" 前端锁紧, 出线孔座</p>	<p>FMK31-0.5/M30 FMK31-1.0/M30</p>	<p>10093222 10093223</p>	<p>3x16AWG(3x1.5mm<sup>2</sup>) PVC 105°C 600V 9A</p>	<p>1.GN/YE 2.BN 3.BU</p>
	<p>FMK41-0.5/M30 FMK41-1.0/M30</p>	<p>10093224 10093225</p>	<p>4x16AWG(4x1.5mm<sup>2</sup>) PVC 105°C 600V 9A</p>	<p>1.RD 2.GN 3.WH 4.BK</p>
	<p>FMK51-0.5/M30 FMK51-1.0/M30</p>	<p>10093226 10093227</p>	<p>5x16AWG(5x1.5mm<sup>2</sup>) PVC 105°C 600V 9A</p>	<p>1.BK 2.BU 3.GN/YE 4.BN 5.WH</p>
<p>开孔尺寸</p>	<p>FMK61-0.5/M30 FMK61-1.0/M30</p>	<p>10093228 10093229</p>	<p>6x16AWG(6x1.5mm<sup>2</sup>) PVC 105°C 600V 9A</p>	<p>1.WH 2.RD 3.GN 4.OR 5.BK 6.BU</p>

## 3针/4针/5针/6针7/8' 前锁紧法兰连接器

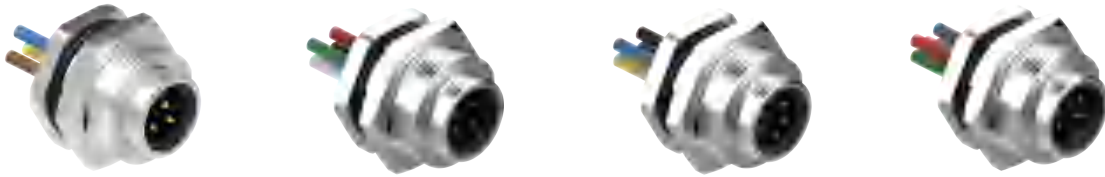

法兰连接器	型号	订货号	特性描述	针脚编号分布
<p>7/8" 前端锁紧, 出线 针座</p>	<p>FMZ31-0.5/M30 FMZ31-1.0/M30</p>	<p>10093230 10093231</p>	<p>3x16AWG(3x1.5mm<sup>2</sup>) PVC 105°C 600V 9A</p>	<p>1.GN/YE 2.BN 3.BU</p>
	<p>FMZ41-0.5/M30 FMZ41-1.0/M30</p>	<p>10093232 10093233</p>	<p>4x16AWG(4x1.5mm<sup>2</sup>) PVC 105°C 600V 9A</p>	<p>1.RD 2.GN 3.WH 4.BK</p>
	<p>FMZ51-0.5/M30 FMZ51-1.0/M30</p>	<p>10093234 10093235</p>	<p>5x16AWG(5x1.5mm<sup>2</sup>) PVC 105°C 600V 9A</p>	<p>1.BK 2.BU 3.GN/YE 4.BN 5.WH</p>
<p>开孔尺寸</p>	<p>FMZ61-0.5/M30 FMZ61-1.0/M30</p>	<p>10093236 10093237</p>	<p>6x16AWG(6x1.5mm<sup>2</sup>) PVC 105°C 600V 9A</p>	<p>1.WH 2.RD 3.GN 4.OR 5.BK 6.BU</p>



法兰连接器	型号	订货号	特性描述	针脚编号分布
<p>7/8" 转换接头</p> <p>建议开孔尺寸</p>	FMK3 FMZ3/7/8	10041180	3芯 公-母 105°C 600V 9A	
	FMK4 FMZ4/7/8	10042080	4芯 公-母 105°C 600V 9A	
	FMK5 FMZ5/7/8	10042081	5芯 公-母 105°C 600V 9A	
	FMK6 FMZ6/7/8	10041181	6芯 公-母 105°C 600V 9A	



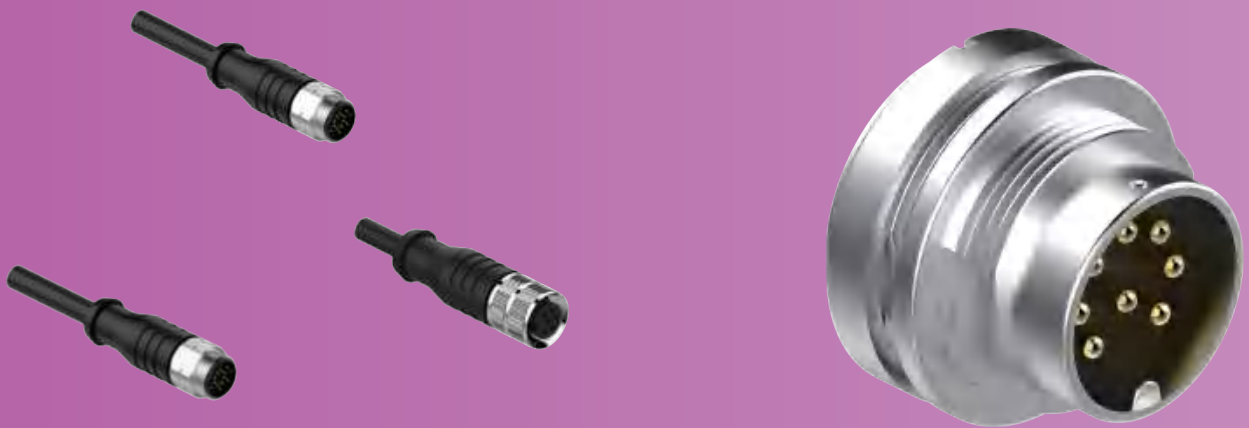

## ■ M16 工业连接器

# M16预铸式连接器型号命名规则

## 预铸式连接器命名规则

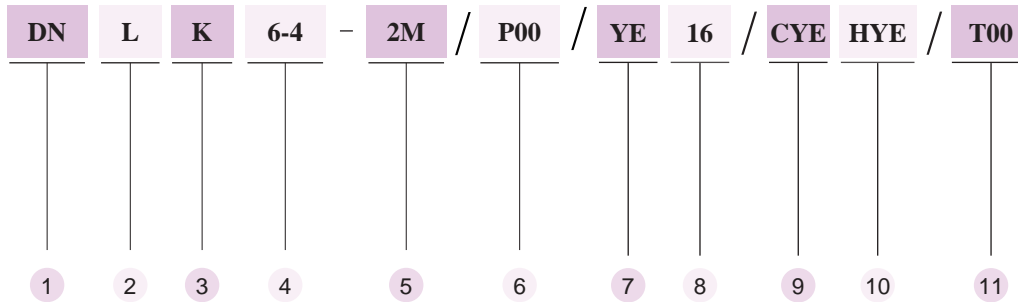

- |   |   |
|---|---|
| <p>1 DN M16x0.75连接器_内螺纹<br/>DW M16x0.75连接器_外螺纹</p> <p>2 Blank 直线型<br/>L 直角型</p> <p>3 K 孔座<br/>Z 针座</p> <p>4 针脚数<br/>6-4 6针接4线<br/>8-8 8针接8线<br/>14-10 14针接10线</p> <p>5 线缆长度[m]</p> <p>6 线缆材质代码<br/>参考电缆型号说明</p> | <p>7 电缆颜色<br/>Blank 标准色<br/>GY 灰色<br/>GN 绿色</p> <p>8 电缆线规<br/>Blank 标准线规 14AWG 3 - 4pin<br/>18AWG 5 - 8pin<br/>24AWG 12-19pin<br/>16 16AWG:1.5mm<sup>2</sup><br/>18 18AWG:0.75mm<sup>2</sup></p> <p>9 针托颜色<br/>Blank 标准色黑色<br/>CYE 黄色针托</p> <p>10 预铸接头颜色<br/>Blank 标准色黑色<br/>HGY 灰色预铸头</p> <p>11 特殊规格定制</p> |
|---|---|

## 双端预铸连接器型号说明



DNK6-6 DWZ6-6-2M/P00



DNLK6-6 DWZ6-6-2M/P00



DNK6-6 DWLZ6-6-2M/P00

## 法兰连接器命名规则

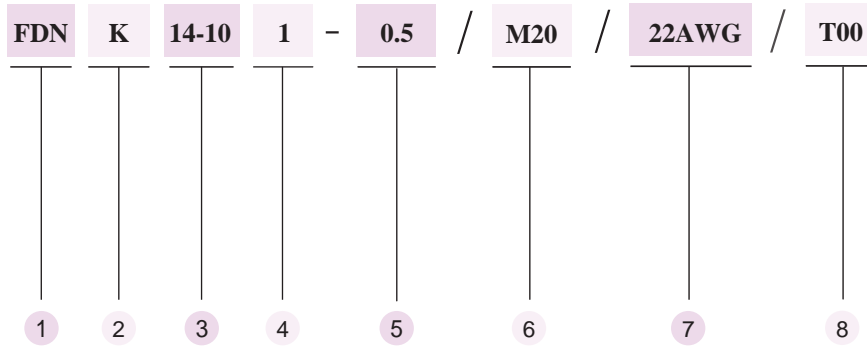

1 FDN M16X0.75 连接器\_内螺纹  
FDW M16X0.75 连接器\_外螺纹

2 K 孔座  
Z 针座

3 针脚数  
14-10 (14针接10线)  
14-14 (14针接14线)  
19-19 (19针接19线)

4 固定方式  
1 前端拧紧型  
2 后端拧紧型

5 0.5 尾线长度 0.5m  
L 导线焊接触点  
P PCB焊接触点

6 连接螺纹规格  
M20 M20X1  
M18 M18X1

7 线规  
Blank:标准线规  
电源3-4针 14AWG  
薄型2-8针 18AWG  
薄型12-19针 24AWG

8 特殊规格定制  
T900 薄型法兰

## 现场可接线连接器命名规则

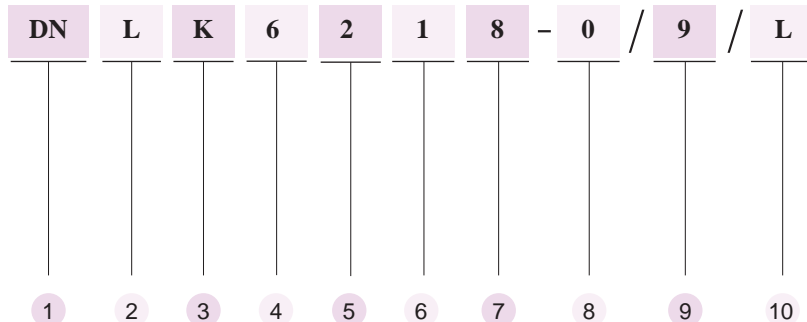

1 DN M16x0.75 连接器\_内螺纹  
DW M16x0.75 连接器\_外螺纹

2 Blank 直线型  
L 直角型

3 K 孔座  
Z 针座

4 针脚数  
编号分配

5 触点材质  
1 铜合金镀银  
2 铜合金镀金

6 1 A-CODE

7 外壳材质  
8 黄铜镀镍金属外壳  
9 不锈钢外壳

8 后端连接方式  
0:单输出口  
1:双输出口

9 电缆接口  
9 PG9  
11 PG11  
13.5 PG13.5

10 连接方式  
Blank 螺钉连接  
L 焊接连接  
C 压接连接

## 3针/4针M16 预铸式连接器

- 预铸接头:TPU材质,黑色
- 锁紧螺母:黄铜镀镍
- 针托:TPU材质,黑色
- 触点:黄铜镀金
- 密封圈:FPM/FKM
- 防护等级:IP67
- 电流等级:15A
- 电压等级:600V
- 绝缘电阻: $\geq 10^9 \Omega$
- 接触电阻: $\leq 5m\Omega$
- 污染等级:3
- 使用环境温度: $-40 \sim +80^\circ\text{C}$
- 可插拔寿命:最小100次
- 电缆最大外径: 10mm



法兰连接器	型号	订货号	特性描述	针脚排列图
直线孔座DNK.** 	DNK3-3-2M/P00 DNK3-3-5M/P00 DNK3-3-10M/P00	10100202 10100203 10100204	黑色PVC电缆 3x14AWG (3x2.5mm <sup>2</sup> ) Ø9.6mm 电缆型号: 58460911-*M	孔座 
直角孔座DNLK.** 	DNLK3-3-2M/P00 DNLK3-3-5M/P00 DNLK3-3-10M/P00	10100205 10100206 10100207		
直线针座DWZ.** 	DWZ3-3-2M/P00 DWZ3-3-5M/P00 DWZ3-3-10M/P00	10100208 10100209 10100260	黑色PVC电缆 3x14AWG (3x2.5mm <sup>2</sup> ) Ø9.6mm 电缆型号: 58460911-*M	针座 
直角针座DWLZ.** 	DWLZ3-3-2M/P00 DWLZ3-3-5M/P00 DWLZ3-3-10M/P00	10100270 10100271 10093238		
直线孔座DNK.** 	DNK4-4-2M/P00 DNK4-4-5M/P00 DNK4-4-10M/P00	10100220 10100221 10100222	黑色PVC电缆 4x14AWG (4x2.5mm <sup>2</sup> ) Ø10.3mm 电缆型号: 58463911-*M	孔座 
直角孔座DNLK.** 	DNLK4-4-2M/P00 DNLK4-4-5M/P00 DNLK4-4-10M/P00	10100223 10100224 10100225		
直线针座DWZ.** 	DWZ4-4-2M/P00 DWZ4-4-5M/P00 DWZ4-4-10M/P00	10100226 10100227 10100228	黑色PVC电缆 4x14AWG (4x2.5mm <sup>2</sup> ) Ø10.3mm 电缆型号: 58463911-*M	针座 
直角针座DWLZ.** 	DWLZ4-4-2M/P00 DWLZ4-4-5M/P00 DWLZ4-4-10M/P00	10100229 10100230 10100231		

\* 标准长度为2/5/10米,可订制任意长度

\*\* 标准锁紧螺母材质为黄铜镀镍

\*\*\*单端尾部标准长度为100mm

## 6针M16预铸式连接器

- 预铸接头:TPU材质,黑色
- 锁紧螺母:黄铜镀镍
- 针托:TPU材质,黑色
- 触点:黄铜镀金
- 密封圈:FPM/FKM
- 防护等级:IP67
- 电流等级:7A
- 电压等级:300V
- 绝缘电阻: $\geq 10^9 \Omega$
- 接触电阻: $\leq 5m\Omega$
- 污染等级:3
- 使用环境温度: $-40 \sim +80^\circ\text{C}$
- 可插拔寿命:最小100次
- 电缆最大外径: 10mm



法兰连接器	型号	订货号	特性描述	针脚排列图
<b>直线孔座DNK..**</b> 	DNK6-4-2M/P00 DNK6-4-5M/P00 DNK6-4-10M/P00	10100000 10100014 10100016	黑色PVC电缆 4x18AWG (4x0.75mm <sup>2</sup> ) Ø7.0mm 电缆型号: 58027151-*M	<b>孔座</b> <ul style="list-style-type: none"> <li>1.BU (CAN-)</li> <li>2.WH (CAN+)</li> <li>3.N/C</li> <li>4.N/C</li> <li>5.RD (+24V)</li> <li>6.BK (GND)</li> </ul>
<b>直角孔座DNLK..**</b> 	DNLK6-4-2M/P00 DNLK6-4-5M/P00 DNLK6-4-10M/P00	10100010 10100015 10100017		
<b>直线针座DWZ..**</b> 	DWZ6-4-2M/P00 DWZ6-4-5M/P00 DWZ6-4-10M/P00	10100020 10100023 10100024	黑色PVC电缆 4x18AWG (4x0.75mm <sup>2</sup> ) Ø7.0mm 电缆型号: 58027151-*M	<b>针座</b> <ul style="list-style-type: none"> <li>1.BU (CAN-)</li> <li>2.WH (CAN+)</li> <li>3.N/C</li> <li>4.N/C</li> <li>5.RD (+24V)</li> <li>6.BK (GND)</li> </ul>
<b>直角针座DWLZ..**</b> 	DWLZ6-4-2M/P00 DWLZ6-4-5M/P00 DWLZ6-4-10M/P00	10100030 10100082 10100083		
<b>直线孔座DNK..**</b> 	DNK6-6-2M/P00 DNK6-6-5M/P00 DNK6-6-10M/P00	10100050 10100066 10100018	黑色PVC电缆 6x18AWG (6x0.75mm <sup>2</sup> ) Ø7.5mm 电缆型号: 58616351-*M	<b>孔座</b> <ul style="list-style-type: none"> <li>1.BN</li> <li>2.WH</li> <li>3.BU</li> <li>4.BK</li> <li>5.GY</li> <li>6.PK</li> </ul>
<b>直角孔座DNLK..**</b> 	DNLK6-6-2M/P00 DNLK6-6-5M/P00 DNLK6-6-10M/P00	10100060 10100019 10100026		
<b>直线针座DWZ..**</b> 	DWZ6-6-2M/P00 DWZ6-6-5M/P00 DWZ6-6-10M/P00	10100070 10100027 10100028	黑色PVC电缆 6x18AWG (6x0.75mm <sup>2</sup> ) Ø7.5mm 电缆型号: 58616351-*M	<b>针座</b> <ul style="list-style-type: none"> <li>1.BN</li> <li>2.WH</li> <li>3.BU</li> <li>4.BK</li> <li>5.GY</li> <li>6.PK</li> </ul>
<b>直角针座DWLZ..**</b> 	DWLZ6-6-2M/P00 DWLZ6-6-5M/P00 DWLZ6-6-10M/P00	10100080 10100084 10100085		

\* 标准长度为2/5/10米,可订制任意长度

\*\* 标准锁紧螺母材质为黄铜镀镍

\*\*\*单端尾部标准长度为100mm

## 8针/14针M16预铸式连接器

- 预铸接头:TPU材质,黑色
- 锁紧螺母:黄铜镀镍
- 针托:TPU材质,黑色
- 触点:黄铜镀金
- 密封圈:FPM/FKM
- 防护等级:IP67
- 电流等级:7A(8x18AWG), 3A(2x20+8x24AWG)
- 电压等级:125V(8x18AWG), 30V(2x20+8x24AWG)
- 绝缘电阻: $\geq 10^9 \Omega$
- 接触电阻: $\leq 5m\Omega$
- 污染等级:3
- 使用环境温度:-40~+80°C
- 可插拔寿命:最小100次
- 电缆最大外径: 10mm



法兰连接器	型号	订货号	特性描述	针脚排列图
<b>直线孔座DNK..**</b> 	DNK8-8-2M/P00 DNK8-8-5M/P00 DNK8-8-10M/P00	10100112 10100113 10100114	黑色PVC电缆 8x18AWG (8x0.75mm <sup>2</sup> ) Ø8.5mm 电缆型号: 58004151-*M	<b>孔座</b>  1. WH 2. BN 3. GN 4. YE 5. GY 6. PK 7. BU 8. RD
<b>直角孔座DNLK..**</b> 	DNLK8-8-2M/P00 DNLK8-8-5M/P00 DNLK8-8-10M/P00	10100115 10100116 10100117		
<b>直线针座DWZ..**</b> 	DWZ8-8-2M/P00 DWZ8-8-5M/P00 DWZ8-8-10M/P00	10100021 10100106 10100107	黑色PVC电缆 8x18AWG (8x0.75mm <sup>2</sup> ) Ø8.5mm 电缆型号: 58004151-*M	<b>针座</b>  1. WH 2. BN 3. GN 4. YE 5. GY 6. PK 7. BU 8. RD
<b>直角针座DWLZ..**</b> 	DWLZ8-8-2M/P00 DWLZ8-8-5M/P00 DWLZ8-8-10M/P00	10100108 10100109 10100067		
<b>直线孔座DNK..**</b> 	DNK14-10-2M/P00 DNK14-10-5M/P00 DNK14-10-10M/P00	10100100 10052335 10100102	黑色PVC电缆 2x20AWG +8x24AWG (2x0.5mm <sup>2</sup> +8x0.25mm <sup>2</sup> ) Ø8.0mm 电缆型号: 58503161-*M	<b>孔座</b>  A.BN C.N/C E.BK G.PK J.GN L.BU M.与A短接 N.N/C O.VT P.WH R.RD S.GY T.YE U.与L短接
<b>直角孔座DNLK..**</b> 	DNLK14-10-2M/P00 DNLK14-10-5M/P00 DNLK14-10-10M/P00	10100110 10100111 10052334		
<b>直线针座DWZ..**</b> 	DWZ14-10-2M/P00 DWZ14-10-5M/P00 DWZ14-10-10M/P00	10100120 10100118 10100119	黑色PVC 电缆 2x20AWG +8x24AWG (2x0.5mm <sup>2</sup> +8x0.25mm <sup>2</sup> ) Ø8.0mm 电缆型号: 58503161-*M	<b>针座</b>  A.BN C.N/C E.BK G.PK J.GN L.BU M.与A短接 N.N/C O.VT P.WH R.RD S.GY T.YE U.与L短接
<b>直角针座DWLZ..**</b> 	DWLZ14-10-2M/P00 DWLZ14-10-5M/P00 DWLZ14-10-10M/P00	10100130 10100128 10100129		

\* 标准长度为2/5/10米,可订制任意长度

\*\* 标准锁紧螺母材质为黄铜镀镍

\*\*\*单端尾部标准长度为100mm

## 14/19针 M16 预铸式连接器

- 预铸接头:TPU材质,黑色
- 锁紧螺母:黄铜镀镍
- 针托:TPU材质,黑色
- 触点:黄铜镀金
- 密封圈:FPM/FKM
- 防护等级:IP67
- 电流等级:3A(14x24AWG)
- 电压等级:30V(14x24AWG)
- 绝缘电阻: $\geq 10^9 \Omega$
- 接触电阻: $\leq 5m\Omega$
- 污染等级:3
- 使用环境温度: $-40 \sim +80^\circ\text{C}$
- 可插拔寿命:最小100次
- 电缆最大外径: 10mm



法兰连接器	型号	订货号	特性描述	针脚排列图
<b>直线孔座DNK..**</b> 	DNK14-14-2M/P00 DNK14-14-5M/P00 DNK14-14-10M/P00	10100150 10100151 10100152	黑色PVC电缆 14*24AWG (14*0.25mm <sup>2</sup> ) Ø7.4mm 电缆型号: 58432911-*M	<b>孔座</b> 
<b>直角孔座DNLK..**</b> 	DNLK14-14-2M/P00 DNLK14-14-5M/P00 DNLK14-14-10M/P00	10100170 10100171 10100172		<b>针座</b> 
<b>直线针座DWZ..**</b> 	DWZ14-14-2M/P00 DWZ14-14-5M/P00 DWZ14-14-10M/P00	10100190 10100191 10100192		<b>针座</b> 
<b>直角针座DWLZ..**</b> 	DWLZ14-14-2M/P00 DWLZ14-14-5M/P00 DWLZ14-14-10M/P00	10100210 10100211 10100212		<b>针座</b> 



\* 标准长度为2/5/10米,可订制任意长度

\*\* 标准锁紧螺母材质为黄铜镀镍

\*\*\*单端尾部标准长度为100mm

# 6针/8针/14针/19针M16现场可接线连接器

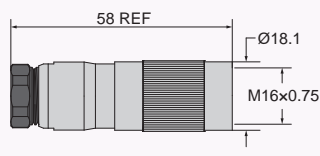

现场可接线连接器	型号	订货号	特性描述	针脚排列图
M16x0.75 直线孔座 - 焊接连接	DNK6218-0/9/L	10255336	铜镀镍金属外壳, PBT尾部螺母 PG 9 电缆出线口 可连接的电缆外径范围: 6-8 mm 可连接的最大线芯: 18AWG(0.75 mm <sup>2</sup> ) 焊接连接 250 V, 5 A 85°C IP67	孔座 
	DNK8218-0/9/L	10052353	铜镀镍金属外壳, PBT尾部螺母 PG 9 电缆出线口 可连接的电缆外径范围: 6-8 mm 可连接的最大线芯: 18AWG(0.75 mm <sup>2</sup> ) 焊接连接 60 V, 5 A 85°C IP67	孔座 
	DNK14218-0/9/L	10100166	铜镀镍金属外壳, PBT尾部螺母 PG 9 电缆出线口 可连接的电缆外径范围: 6-8 mm 可连接的最大线芯: 24AWG(0.25 mm <sup>2</sup> ) 焊接连接 60 V, 3 A 85°C IP67	孔座 

## 6针/8针/14针/19针M16现场可接线连接器



现场可接线连接器	型号	订货号	特性描述	针脚排列图
M16x0.75 直线针座 - 焊接连接  	DWZ6218-0/9/L	10044056	铜镀镍金属外壳, PBT尾部螺母 PG 9 电缆出线口 可连接的电缆外径范围: 6-8 mm 可连接的最大线芯: 18AWG(0.75 mm <sup>2</sup> ) 焊接连接 250 V, 5 A 85°C IP67	针座  
	DWZ8218-0/9/L	10044054	铜镀镍金属外壳, PBT尾部螺母 PG 9 电缆出线口 可连接的电缆外径范围: 6-8 mm 可连接的最大线芯: 18AWG(0.75 mm <sup>2</sup> ) 焊接连接 60 V, 5 A 85°C IP67	针座  
	DWZ14218-0/9/L	10100167	铜镀镍金属外壳, PBT尾部螺母 PG 9 电缆出线口 可连接的电缆外径范围: 6-8 mm 可连接的最大线芯: 24AWG(0.25 mm <sup>2</sup> ) 焊接连接 60 V, 3 A 85°C IP67	针座  
	DWZ19218-0/9/L	10093239	铜镀镍金属外壳, PBT尾部螺母 PG 9 电缆出线口 可连接的电缆外径范围: 6-8 mm 可连接的最大线芯: 24AWG(0.25 mm <sup>2</sup> ) 焊接连接 60 V, 3 A 85°C IP67	针座  

# 3针/4针M16电源法兰连接器



法兰连接器	型号	订货号	特性描述	针脚排列图
M16后端锁紧, 出线 孔座 	FDNK3-32-0.5/M20 FDNK3-32-1.0/M20	10100240 10100241	3x14AWG(3x2.5 mm <sup>2</sup> ) PVC 105°C 600V 15A	孔座 1.WH 2.GN 3.BK
	FDNK4-42-0.5/M20 FDNK4-42-1.0/M20	10100242 10100243	4x14AWG(4x2.5 mm <sup>2</sup> ) PVC 105°C 600V 15A	孔座 1.WH 2.GN 3.BK 4.RD
M16后端锁紧, 出线 针座 	FDWZ3-32-0.5/M20 FDWZ3-32-1.0/M20	10100244 10100245	3x14AWG(3x2.5 mm <sup>2</sup> ) PVC 105°C 600V 15A	针座 1.WH 2.GN 3.BK
	FDWZ4-42-0.5/M20 FDWZ4-42-1.0/M20	10100246 10100247	4x14AWG(4x2.5 mm <sup>2</sup> ) PVC 105°C 600V 15A	针座 1.WH 2.GN 3.BK 4.RD



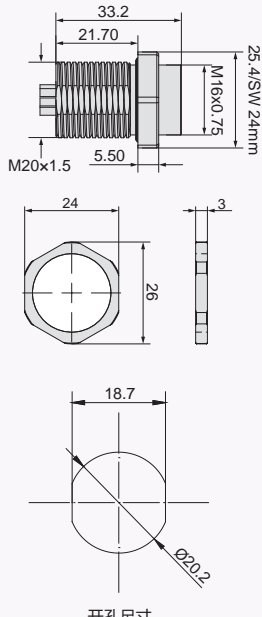
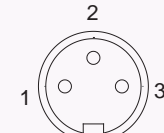
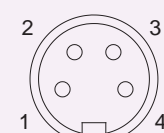
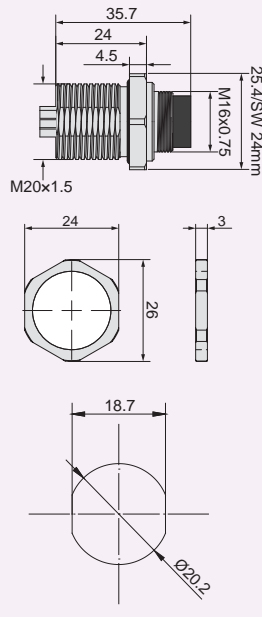
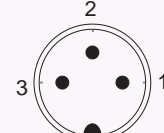
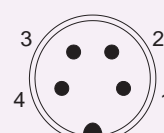

法兰连接器	型号	订货号	特性描述	针脚排列图
M16后端锁紧,焊接 孔座 	FDNK32-L/M20	10100250	最大焊接: 14AWG(2.5mm <sup>2</sup> ) ~-40+80°C 600V 15A	孔座 
	FDNK42-L/M20	10100251	最大焊接: 14AWG(2.5mm <sup>2</sup> ) ~-40+80°C 600V 15A	孔座 
M16后端锁紧,焊接 针座 	FDWZ32-L/M20	10100252	最大焊接: 14AWG(2.5mm <sup>2</sup> ) ~-40+80°C 600V 15A	针座 
	FDWZ42-L/M20	10100253	最大焊接: 14AWG(2.5mm <sup>2</sup> ) ~-40+80°C 600V 15A	针座 

# 6针/8针/14针M16法兰连接器

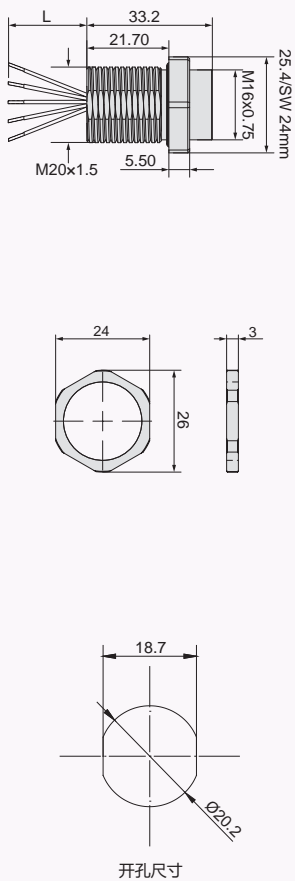
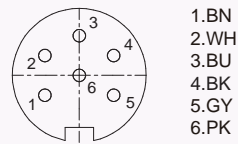
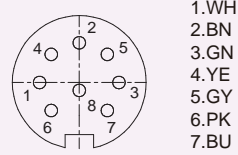
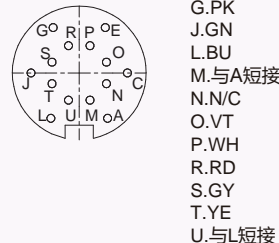
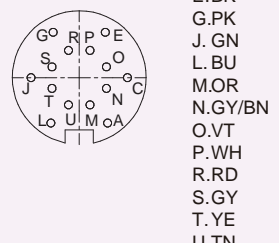

法兰连接器	型号	订货号	特性描述	针脚排列图
M16后端锁紧, 出线 孔座  	FDNK6-62-0.5/M20 FDNK6-62-1.0/M20	10044000 10044013	6x18AWG (6x0.75mm <sup>2</sup> ) PVC 105°C 300V 7A	孔座  
	FDNK8-82-0.5/M20 FDNK8-82-1.0/M20	10044011 10044024	8x18AWG (8x0.75mm <sup>2</sup> ) PVC 105°C 300V 7A	孔座  
	FDNK14-102-0.5/M20 FDNK14-102-1.0/M20	10093240 10093241	10x24AWG (10x0.25mm <sup>2</sup> ) PVC 105°C 30V 3A	孔座  
	FDNK14-142-0.5/M20 FDNK14-142-1.0/M20	10044010 10044134	14x24AWG (14x0.25mm <sup>2</sup> ) PVC 105°C 30V 3A	孔座  

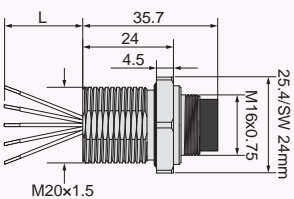
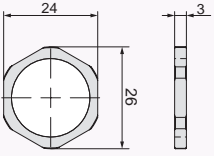
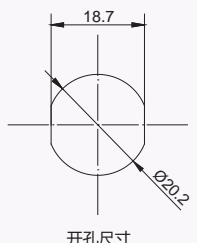
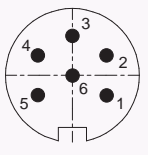
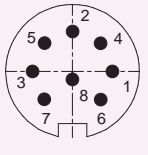
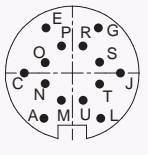

法兰连接器	型号	订货号	特性描述	针脚排列图
M16后端锁紧,出线 针座      	FDWZ6-62-0.5/M20 FDWZ6-62-1.0/M20	10044008 10044023	6x18AWG (6x0.75mm <sup>2</sup> ) PVC 105°C 300V 7A	针座   1.BN 2.WH 3.BU 4.BK 5.GY 6.PK
	FDWZ8-82-0.5/M20 FDWZ8-82-1.0/M20	10044025 10044026	8x18AWG (8x0.75mm <sup>2</sup> ) PVC 105°C 300V 7A	针座   1.WH 2.BN 3.GN 4.YE 5.GY 6.PK 7.BU 8.RD
	FDWZ14-102-0.5/M20 FDWZ14-102-1.0/M20	10093242 10093243	10x24AWG (10x0.25mm <sup>2</sup> ) PVC 105°C 30V 3A	针座   A.BN C.N/C E.BK G.PK J.GN L.BU M.与A短接 N.N/C O.VT P.WH R.RD S.GY T.YE U.与L短接
	FDWZ14-142-0.5/M20 FDWZ14-142-1.0/M20	10044130 10044020	14x24AWG (14x0.25mm <sup>2</sup> ) PVC 105°C 30V 3A	针座   A.BN C.RD/BU E.BK G.PK J.GN L.BU M.OR N.GY/BN O.VT P.WH R.RD S.GY T.YE U.TN

# 6针/8针M16法兰连接器



法兰连接器	型号	订货号	特性描述	针脚排列图
M16后端锁紧,焊接 孔座 	FDNK62-L/M20	10044002	最大焊接: 18AWG(0.75mm <sup>2</sup> ) -40°C~+85°C 300V 7A	孔座 
	FDNK82-L/M20	10044027	最大焊接: 18AWG(0.75mm <sup>2</sup> ) -40°C~+85°C 300V 7A	孔座 
M16后端锁紧,焊接 针座 	FDWZ62-L/M20	10044122	最大焊接: 18AWG(0.75mm <sup>2</sup> ) -40°C~+85°C 300V 7A	针座 
	FDWZ82-L/M20	10044009	最大焊接: 18AWG(0.75mm <sup>2</sup> ) -40°C~+85°C 300V 7A	针座 

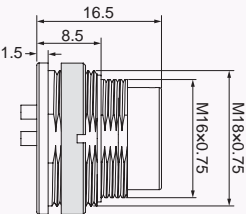
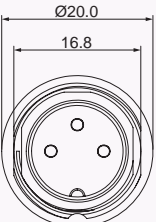
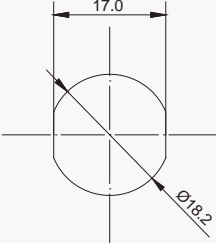
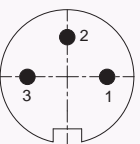
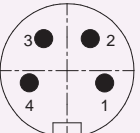
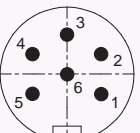
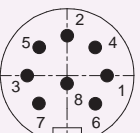

法兰连接器	型号	订货号	特性描述	针脚排列图																										
<p>M16 薄型前端锁紧 焊接 针座</p>   	FDWZ31-L/M18/T900	10100254	最大焊接: 18AWG(0.75mm <sup>2</sup> ) -40°C~+85°C 250V 7A IP40	针座  <table border="1"> <thead> <tr> <th></th> <th>X</th> <th>Y</th> </tr> </thead> <tbody> <tr> <td>1</td> <td>3.50</td> <td>0.00</td> </tr> <tr> <td>2</td> <td>0.00</td> <td>3.50</td> </tr> <tr> <td>3</td> <td>-3.50</td> <td>0.00</td> </tr> </tbody> </table>		X	Y	1	3.50	0.00	2	0.00	3.50	3	-3.50	0.00														
		X	Y																											
	1	3.50	0.00																											
	2	0.00	3.50																											
3	-3.50	0.00																												
FDWZ41-L/M18/T900	10100255	最大焊接: 18AWG(0.75mm <sup>2</sup> ) -40°C~+85°C 250V 6A IP40	针座  <table border="1"> <thead> <tr> <th></th> <th>X</th> <th>Y</th> </tr> </thead> <tbody> <tr> <td>1</td> <td>3.32</td> <td>-1.08</td> </tr> <tr> <td>2</td> <td>2.05</td> <td>2.83</td> </tr> <tr> <td>3</td> <td>-2.05</td> <td>2.83</td> </tr> <tr> <td>4</td> <td>-3.32</td> <td>-1.08</td> </tr> </tbody> </table>		X	Y	1	3.32	-1.08	2	2.05	2.83	3	-2.05	2.83	4	-3.32	-1.08												
	X	Y																												
1	3.32	-1.08																												
2	2.05	2.83																												
3	-2.05	2.83																												
4	-3.32	-1.08																												
FDWZ61-L/M18/T900	10100257	最大焊接: 18AWG(0.75mm <sup>2</sup> ) -40°C~+85°C 250V 5A IP40	针座  <table border="1"> <thead> <tr> <th></th> <th>X</th> <th>Y</th> </tr> </thead> <tbody> <tr> <td>1</td> <td>3.03</td> <td>-1.75</td> </tr> <tr> <td>2</td> <td>3.03</td> <td>1.75</td> </tr> <tr> <td>3</td> <td>0.00</td> <td>3.50</td> </tr> <tr> <td>4</td> <td>-3.03</td> <td>1.75</td> </tr> <tr> <td>5</td> <td>-3.03</td> <td>-1.75</td> </tr> <tr> <td>6</td> <td>0.00</td> <td>0.00</td> </tr> </tbody> </table>		X	Y	1	3.03	-1.75	2	3.03	1.75	3	0.00	3.50	4	-3.03	1.75	5	-3.03	-1.75	6	0.00	0.00						
	X	Y																												
1	3.03	-1.75																												
2	3.03	1.75																												
3	0.00	3.50																												
4	-3.03	1.75																												
5	-3.03	-1.75																												
6	0.00	0.00																												
FDWZ81-L/M18/T900	10100256	最大焊接: 18AWG(0.75mm <sup>2</sup> ) -40°C~+85°C 250V 5A IP40	针座  <table border="1"> <thead> <tr> <th></th> <th>X</th> <th>Y</th> </tr> </thead> <tbody> <tr> <td>1</td> <td>3.50</td> <td>0.00</td> </tr> <tr> <td>2</td> <td>0.00</td> <td>3.50</td> </tr> <tr> <td>3</td> <td>-3.50</td> <td>0.00</td> </tr> <tr> <td>4</td> <td>2.47</td> <td>2.47</td> </tr> <tr> <td>5</td> <td>-2.47</td> <td>2.47</td> </tr> <tr> <td>6</td> <td>2.47</td> <td>-2.47</td> </tr> <tr> <td>7</td> <td>-2.47</td> <td>-2.47</td> </tr> <tr> <td>8</td> <td>0.00</td> <td>-0.70</td> </tr> </tbody> </table>		X	Y	1	3.50	0.00	2	0.00	3.50	3	-3.50	0.00	4	2.47	2.47	5	-2.47	2.47	6	2.47	-2.47	7	-2.47	-2.47	8	0.00	-0.70
	X	Y																												
1	3.50	0.00																												
2	0.00	3.50																												
3	-3.50	0.00																												
4	2.47	2.47																												
5	-2.47	2.47																												
6	2.47	-2.47																												
7	-2.47	-2.47																												
8	0.00	-0.70																												

# 14针M16法兰连接器(薄型)



法兰连接器	型号	订货号	特性描述	针脚排列图
<p>M16 薄型前端锁紧 焊接 针座</p> <p>前锁紧法兰</p> <p>开孔尺寸</p>	<p>FDWZ141-L/M18/T900</p>	<p>10100258</p>	<p>最大焊接: 24AWG(0.25mm<sup>2</sup>) -40°C~+85°C 60V 3A IP40</p>	<p>针座</p>

## 3针/4针/6针/8针M16法兰连接器(薄型)

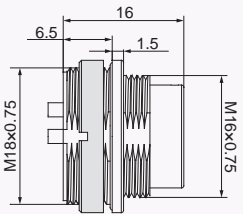
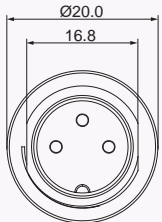
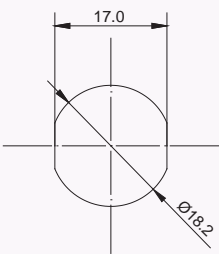
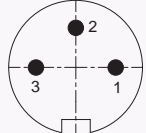
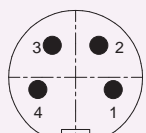
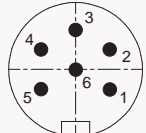
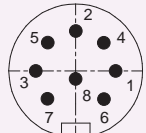

法兰连接器	型号	订货号	特性描述	针脚排列图
<p>M16 薄型后端锁紧 焊接 针座</p>    <p>开孔尺寸</p>	FDWZ32-L/M18/T900	10100290	最大焊接: 18AWG(0.75mm <sup>2</sup> ) -40°C~+85°C 250V 7A IP40	针座 
	FDWZ42-L/M18/T900	10100291	最大焊接: 18AWG(0.75mm <sup>2</sup> ) -40°C~+85°C 250V 6A IP40	针座 
	FDWZ62-L/M18/T900	10100293	最大焊接: 18AWG(0.75mm <sup>2</sup> ) -40°C~+85°C 250V 5A IP40	针座 
	FDWZ82-L/M18/T900	10100292	最大焊接: 18AWG(0.75mm <sup>2</sup> ) -40°C~+85°C 250V 5A IP40	针座 

# 14针M16法兰连接器(薄型)



法兰连接器	型号	订货号	特性描述	针脚排列图
<p>M16 薄型后端锁紧 焊接 针座</p>	<p>FDWZ142-L/M18/T900</p>	<p>10100294</p>	<p>最大焊接: 24AWG(0.25mm<sup>2</sup>) -40°C~+85°C 60V 3A IP40</p>	<p>针座</p>

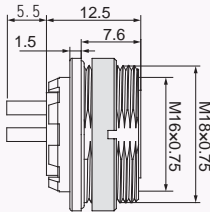
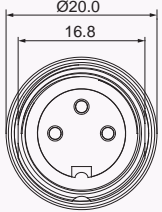
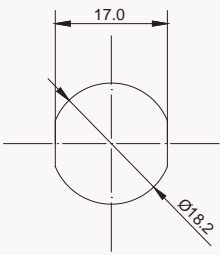
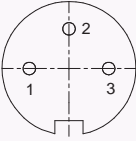
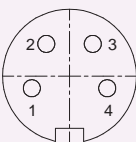
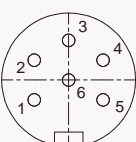
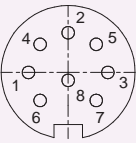

法兰连接器	型号	订货号	特性描述	针脚排列图
<p>M16 薄型前端锁紧 焊接 孔座</p>   	FDNK31-L/M18/T900	10100296	最大焊接: 18AWG(0.75mm <sup>2</sup> ) -40°C~+85°C 250V 7A IP40	孔座 
	FDNK41-L/M18/T900	10100297	最大焊接: 18AWG(0.75mm <sup>2</sup> ) -40°C~+85°C 250V 6A IP40	孔座 
	FDNK61-L/M18/T900	10100298	最大焊接: 18AWG(0.75mm <sup>2</sup> ) -40°C~+85°C 250V 5A IP40	孔座 
	FDNK81-L/M18/T900	10100299	最大焊接: 18AWG(0.75mm <sup>2</sup> ) -40°C~+85°C 250V 5A IP40	孔座 

### 3针/4针/6针/8针M16法兰连接器(薄型)

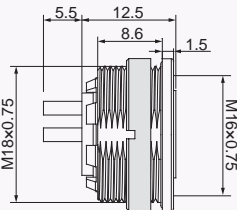
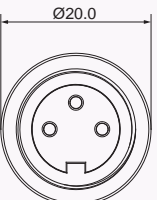
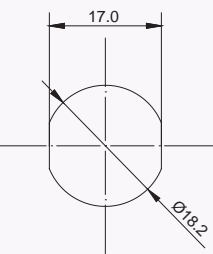
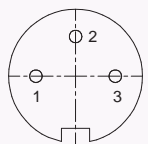
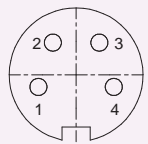
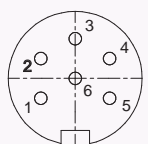
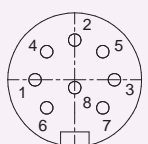

法兰连接器	型号	订货号	特性描述	针脚排列图
<p>M16 薄型后端锁紧 焊接 孔座</p>    <p>开孔尺寸</p>	FDNK32-L/M18/T900	10100300	最大焊接: 18AWG(0.75mm <sup>2</sup> ) -40°C~+85°C 250V 7A IP40	孔座 
	FDNK42-L/M18/T900	10100301	最大焊接: 18AWG(0.75mm <sup>2</sup> ) -40°C~+85°C 250V 6A IP40	孔座 
	FDNK62-L/M18/T900	10100302	最大焊接: 18AWG(0.75mm <sup>2</sup> ) -40°C~+85°C 250V 5A IP40	孔座 
	FDNK82-L/M18/T900	10100303	最大焊接: 18AWG(0.75mm <sup>2</sup> ) -40°C~+85°C 250V 5A IP40	孔座 

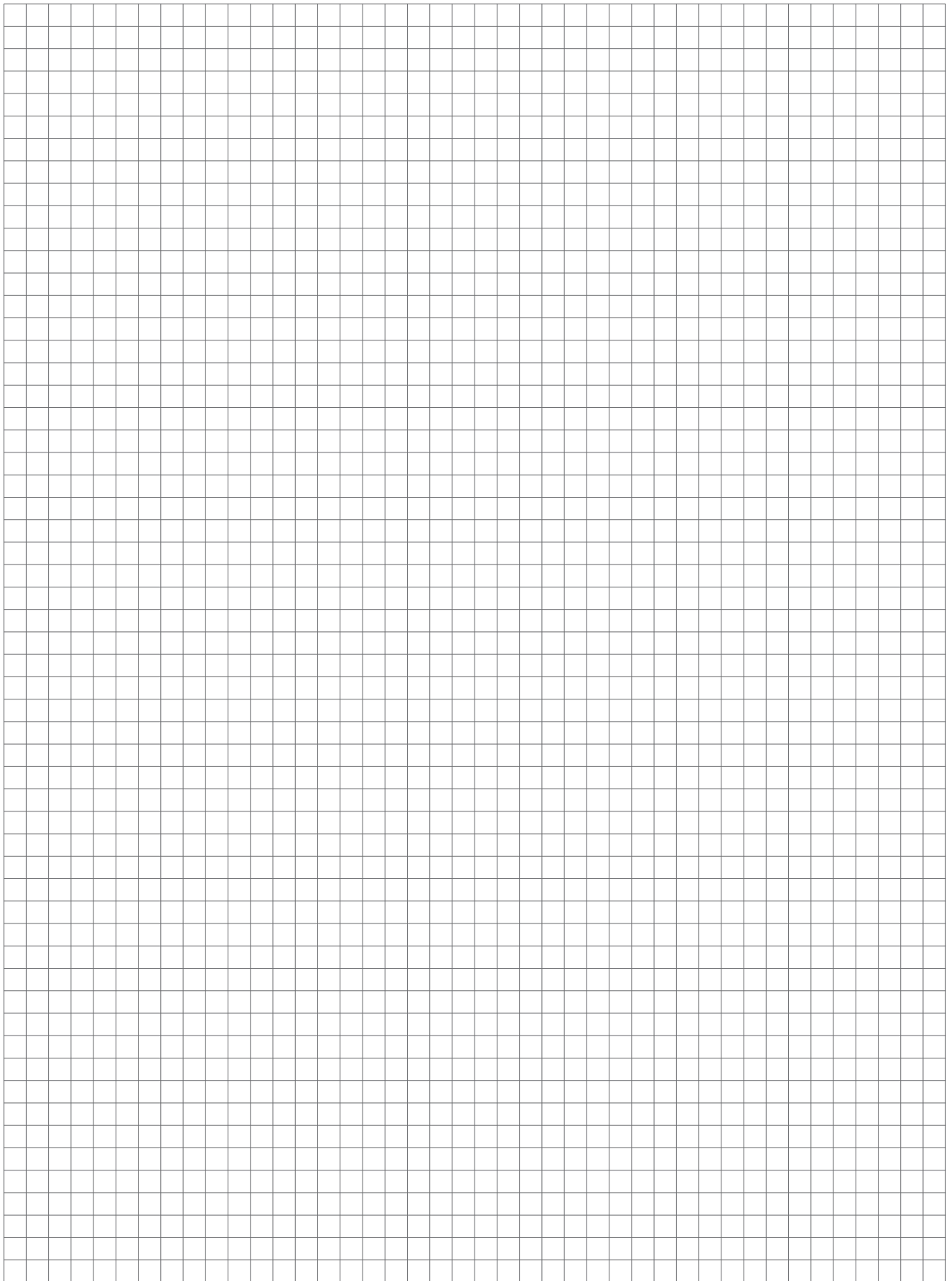



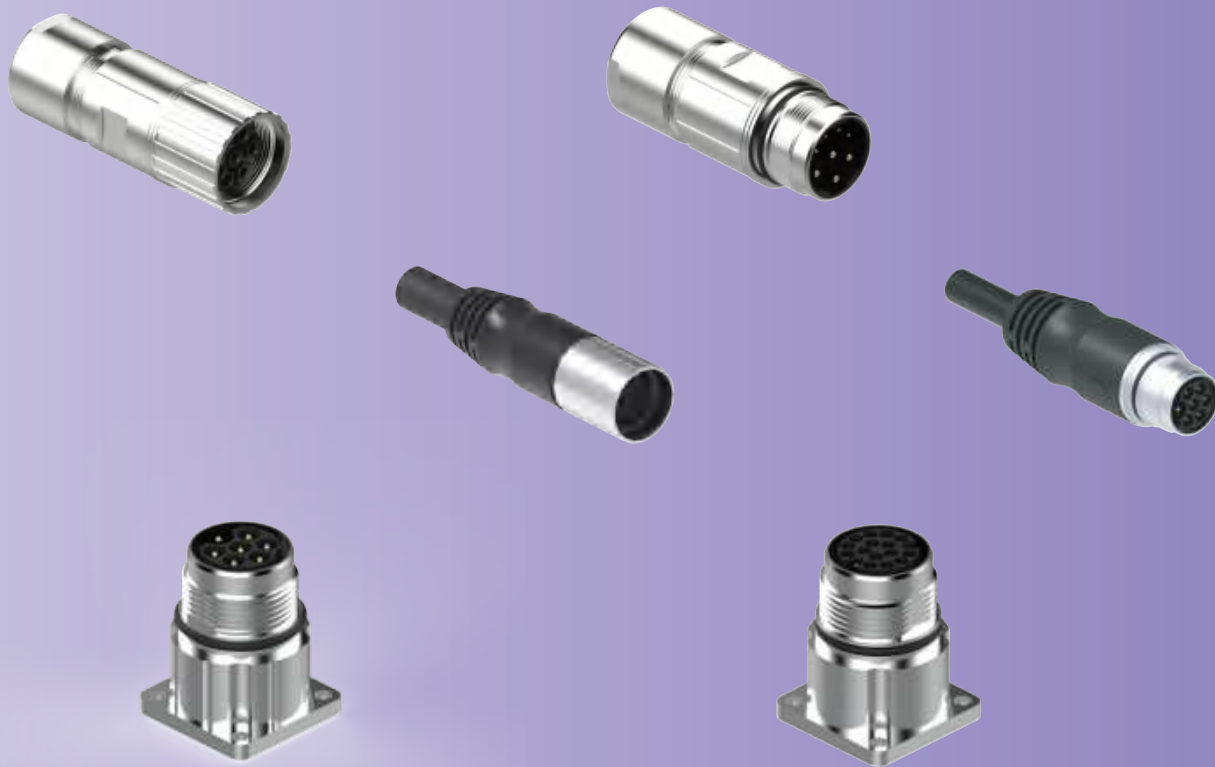

## ■ M17 工业连接器

# M17连接器型号命名规则

## 预铸式连接器命名规则

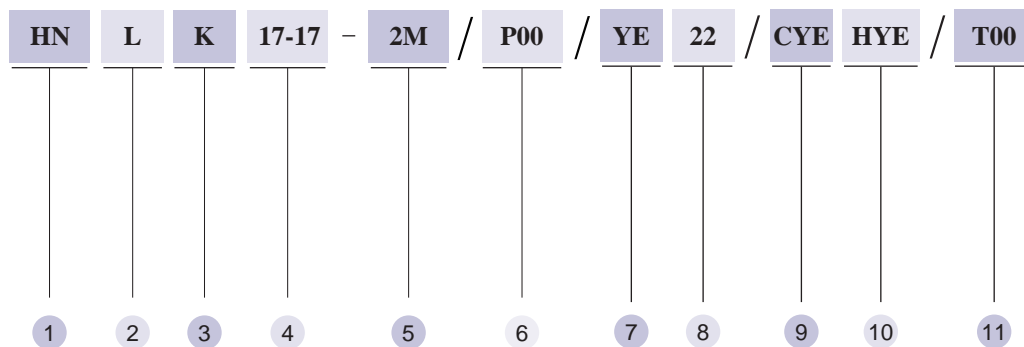

- |  |  |   |
|--|--|---|
| <p>1 HN M17x1 连接器_内螺纹<br/>HW M17x1 连接器_外螺纹</p> <p>2 Blank 直线型<br/>L 直角型</p> <p>3 K 孔座<br/>Z 针座</p> <p>4 针脚数<br/>7-7 7 针接 7 线<br/>17-17 17 针接 17 线</p> <p>5 线缆长度[m]</p> | <p>6 线缆材质代码<br/>参考电缆型号说明</p> <p>7 电缆颜色<br/>Blank 标准色 黑色<br/>GY 灰色<br/>YE 黄色</p> <p>8 电缆线规<br/>Blank 标准线规<br/>18AWG 7 pin<br/>24AWG 17 pin<br/>22 22AWG (17pin)</p> | <p>9 针托颜色<br/>Blank 标准色 黑色</p> <p>10 预铸接头颜色<br/>Blank 标准色 黑色</p> <p>11 特殊规格定制</p> |
|--|--|---|

## 双端预铸连接器型号说明



HNK7-7 HWZ7-7-2M/P00

HNZ7-7 HWK7-7-2M/P00

HNK17-17 HWZ17-17-2M/P00

HNZ17-17 HWK17-17-2M/P00

## 法兰连接器命名规则

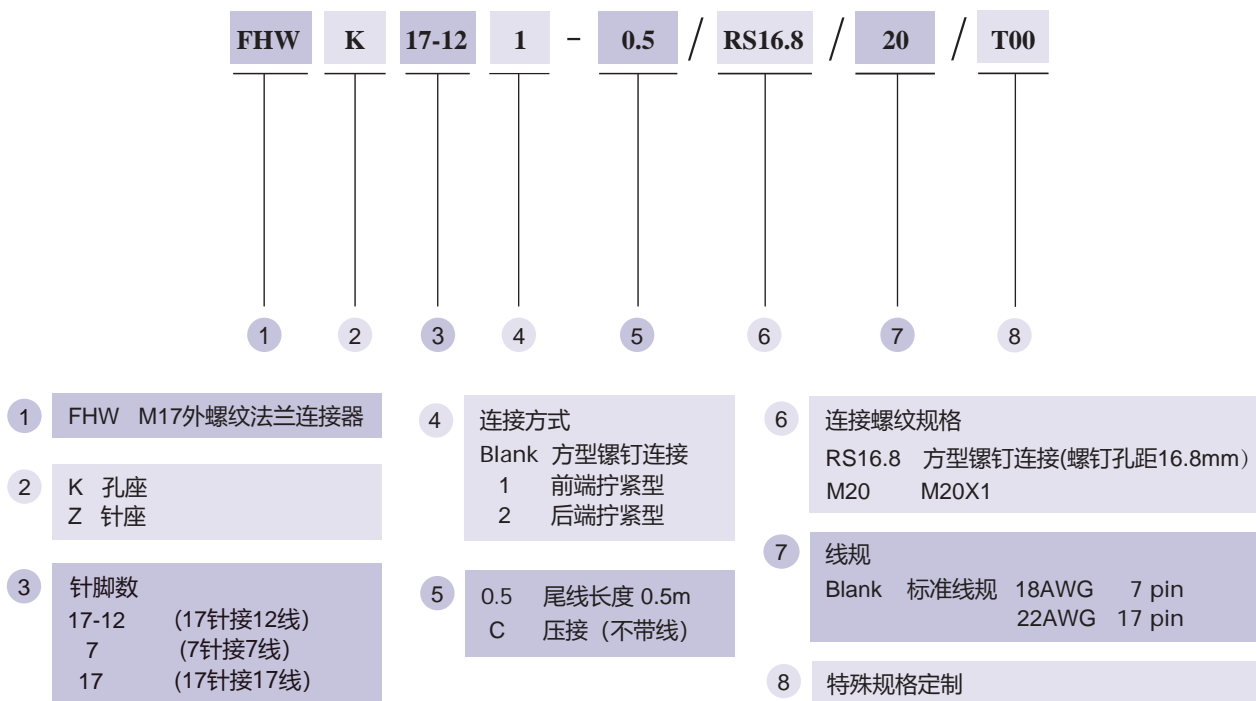

## 现场可接线连接器命名规则



## 7针/17针M17预铸式连接器

- 预铸接头:TPU材质,黑色
- 锁紧螺母:黄铜镀镍
- 针托:PA6/PBT, 黑色
- 触点:黄铜镀金
- 密封圈:NBR
- 防护等级:IP67
- 电流等级:8A/3.6A
- 电压等级:300V/60V
- 绝缘电阻: $\geq 10^9 \Omega$
- 接触电阻: $\leq 5m\Omega$
- 污染等级:3
- 使用环境温度: $-20 \sim +80^\circ\text{C}$
- 可插拔寿命:最小100次
- 电缆最大外径: 12mm



法兰连接器	型号	订货号	特性描述	针脚排列图
直线型内螺纹HN..**  	HNK7-7-5M/P00 HNK7-7-10M/P00	10053020 10053021	黑色PVC电缆 7x18AWG (7x0.75mm <sup>2</sup> ) Ø8mm 电缆型号: 58140911-*M	<div style="display: flex; justify-content: space-between;"> <div style="text-align: center;"> </div> <div style="text-align: right;"> <b>孔座</b>                      1.WH 2.BN 3.GN 4.YE 5.GY 6.PK PE.GN/YE                 </div> </div>
	HNZ7-7-2M/P00	10053060		<div style="display: flex; justify-content: space-between;"> <div style="text-align: center;"> </div> <div style="text-align: right;"> <b>针座</b>                      1.WH 2.BN 3.GN 4.YE 5.GY 6.PK PE.GN/YE                 </div> </div>
	HNK17-17-5M/P00 HNK17-17-10M/P00	10053024 10053025	黑色PVC电缆 17x24AWG (17x0.25mm <sup>2</sup> ) Ø8.2mm 电缆型号: 58142911-*M	<div style="display: flex; justify-content: space-between;"> <div style="text-align: center;"> </div> <div style="text-align: right;"> <b>孔座</b>                      1.VT 7.GY/PK 13.YE/BN 2.RD 8.WH/GN 14.BN/GN 3.GY 9.WH/YE 15.WH 4.RD/BU 10.WH/GY 16.YE 5.GN 11.BK 17.PK 6.BU 12.GN/YE                 </div> </div>
	HNZ17-17-2M/P00	10053062		<div style="display: flex; justify-content: space-between;"> <div style="text-align: center;"> </div> <div style="text-align: right;"> <b>针座</b>                      1.VT 7.GY/PK 13.YE/BN 2.RD 8.WH/GN 14.BN/GN 3.GY 9.WH/YE 15.WH 4.RD/BU 10.WH/GY 16.YE 5.GN 11.BK 17.PK 6.BU 12.GN/YE                 </div> </div>
直线型外螺纹HW..**  	HWK7-7-2M/P10	10053000	黑色PUR电缆 7x18AWG (7x0.75mm <sup>2</sup> ) Ø8mm	<div style="display: flex; justify-content: space-between;"> <div style="text-align: center;"> </div> <div style="text-align: right;"> <b>孔座</b>                      1.WH 2.BN 3.GN 4.YE 5.GY 6.PK PE.GN/YE                 </div> </div>
	HWZ7-7-2M/P10 HWZ7-7-5M/P10 HWZ7-7-10M/P10	10053006 10053063 10053026	黑色PUR电缆 7x18AWG (7x0.75mm <sup>2</sup> ) Ø8mm 电缆型号: 58141911-*M	<div style="display: flex; justify-content: space-between;"> <div style="text-align: center;"> </div> <div style="text-align: right;"> <b>针座</b>                      1.WH 2.BN 3.GN 4.YE 5.GY 6.PK PE.GN/YE                 </div> </div>
	HWK17-17-2M/P10	10053064	黑色PVC电缆 17x24AWG (17x0.25mm <sup>2</sup> ) Ø8.2mm	<div style="display: flex; justify-content: space-between;"> <div style="text-align: center;"> </div> <div style="text-align: right;"> <b>孔座</b>                      1.VT 7.GY/PK 13.YE/BN 2.RD 8.WH/GN 14.BN/GN 3.GY 9.WH/YE 15.WH 4.RD/BU 10.WH/GY 16.YE 5.GN 11.BK 17.PK 6.BU 12.GN/YE                 </div> </div>
	HWZ17-17-2M/P10 HWZ17-17-5M/P10 HWZ17-17-10M/P10	10053002 10053104 10053105	黑色PVC电缆 17x24AWG (17x0.25mm <sup>2</sup> ) Ø8.2mm 电缆型号: 58143911-*M	<div style="display: flex; justify-content: space-between;"> <div style="text-align: center;"> </div> <div style="text-align: right;"> <b>针座</b>                      1.VT 7.GY/PK 13.YE/BN 2.RD 8.WH/GN 14.BN/GN 3.GY 9.WH/YE 15.WH 4.RD/BU 10.WH/GY 16.YE 5.GN 11.BK 17.PK 6.BU 12.GN/YE                 </div> </div>

\* 标准长度为2/5/10米,可订制任意长度

\*\* 标准锁紧螺母材质为黄铜镀镍

# 7针 M17法兰连接器



法兰连接器	型号	订货号	特性描述	针脚排列图
<p>M17方盘法兰，前端锁紧，压接</p> <p>密封圈</p> <p>方盘外形尺寸</p> <p>安装孔尺寸</p>	FHWK7-C/RS16.8	10041674	外壳材质铜锌合金 压接-20°C~+80°C 630V 14A C:可接线芯范围 0.25~1mm <sup>2</sup> C1:可接线芯范围 0.75~1.5mm <sup>2</sup> (型号自带7PIN插针)	孔座 
	FHWK7-C1/RS16.8			
	HK0.25-1-C.728	13021003	接线芯范围:0.25~1mm <sup>2</sup>	
	HK0.75-1.5-C1.728	13021004	接线芯范围:0.75~1.5mm <sup>2</sup>	
	FHWZ7-C/RS16.8	10041675	外壳材质铜锌合金 压接-20°C~+80°C 630V 14A C:可接线芯范围 0.25~1mm <sup>2</sup> C1:可接线芯范围 0.75~1.5mm <sup>2</sup> (型号自带7PIN插针)	针座 
	FHWZ7-C1/RS16.8			
	HZ0.25-1-C.728	13021005	接线芯范围:0.25~1mm <sup>2</sup>	
	HZ0.75-1.5-C1.728	13021006	接线芯范围:0.75~1.5mm <sup>2</sup>	

# 17针M17法兰连接器



法兰连接器	型号	订货号	特性描述	针脚排列图
<p>M17方盘法兰, 前端锁紧, 压接</p> <p>方盘外形尺寸</p> <p>安装孔尺寸</p>	FHWK17-C/RS16.8	10041676	外壳材质铜锌合金 压接-20°C~+80°C 60V 3.6A C:可接线芯范围: 0.14~0.5mm <sup>2</sup> (型号自带17PIN插针)	孔座 
	HK0.14-0.5-C.1728	13021001	接线芯范围:0.14~0.5mm <sup>2</sup>	
	FHWZ17-C/RS16.8	10041668	外壳材质铜锌合金 压接-20°C~+80°C 60V 3.6A C:可接线芯范围 0.14~0.5mm <sup>2</sup> (型号自带17PIN插针)	针座 
	HZ0.14-0.5-C.1728	13021002	接线芯范围:0.14~0.5mm <sup>2</sup>	

# 7针M17现场可接线连接器



现场可接线连接器	型号	订货号	特性描述	针脚排列图
<b>M17 直线型_内螺纹 压接</b> 	HNK728-0/M18/C	10053012	铜镀镍金属外壳 可接电缆外径范围: 7-12mm 630V, 14A -20°C~+80°C 压接连接: /C 母针型号HK0.25-1-C.728 公针型号HZ0.25-1-C.728 可接线芯范围:0.25~1mm <sup>2</sup> /C1 母针型号HK0.75-1.5-C1.728 公针型号HZ0.75-1.5-C1.728 可接线芯范围:0.75~1.5mm <sup>2</sup> (型号自带7PIN插针)	
	HNK728-0/M18/C1	10053200		
	HNZ728-0/M18/C	10095576		
	HNZ728-0/M18/C1			
<b>M17 直线型_外螺纹 压接</b> 	HWK728-0/M18/C	10041679	/C 母针型号HK0.25-1-C.728 公针型号HZ0.25-1-C.728 可接线芯范围:0.25~1mm <sup>2</sup> /C1 母针型号HK0.75-1.5-C1.728 公针型号HZ0.75-1.5-C1.728 可接线芯范围:0.75~1.5mm <sup>2</sup> (型号自带7PIN插针)	
	HWK728-0/M18/C1	10053202		
	HWZ728-0/M18/C	10053013		
	HWZ728-0/M18/C1	10053203		
母针	HK0.25-1-C.728	13021003	接线芯范围:0.25~1mm <sup>2</sup>	
	HK0.75-1.5-C1.728	13021004	接线芯范围:0.75~1.5mm <sup>2</sup>	
公针	HZ0.25-1-C.728	13021005	接线芯范围:0.25~1mm <sup>2</sup>	
	HZ0.75-1.5-C1.728	13021006	接线芯范围:0.75~1.5mm <sup>2</sup>	

# 17针M17现场可接线连接器



现场可接线连接器	型号	订货号	特性描述	针脚排列图
M17直线型_内螺纹 压接 	HNK1728-0/M18/C	10052699	铜镀镍金属外壳 可接电缆外径范围:7-12mm 60 V, 3.6A -20°C~+80°C 压接连接: /C 母针型号HK0.14-0.5-C.1728 公针型号HZ0.14-0.5-C.1728 可接线芯范围:0.14~0.5mm <sup>2</sup> (型号自带17PIN插针)	孔座 
	HNZ1728-0/M18/C	10044264		针座 
M17直线型_外螺纹 压接 	HWK1728-0/M18/C	10053050		孔座 
	HWZ1728-0/M18/C	10053014		针座 
母针	HK0.14-0.5-C.1728	13021001	接线芯范围:0.14~0.5mm <sup>2</sup>	
公针	HZ0.14-0.5-C.1728	13021002	接线芯范围:0.14~0.5mm <sup>2</sup>	

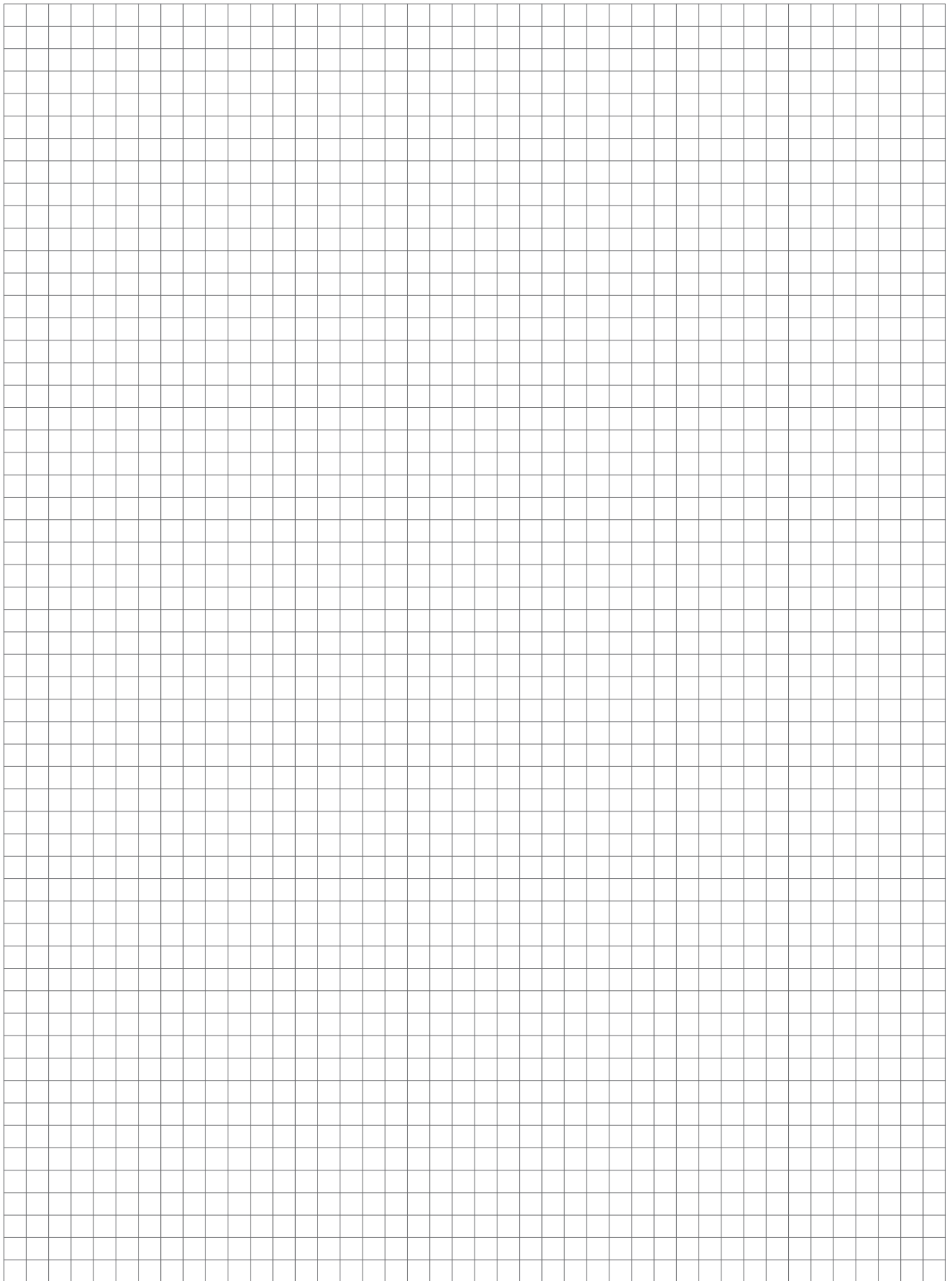





## ■ M23 工业连接器

# M23预铸式连接器型号命名规则

## 预铸式连接器命名规则

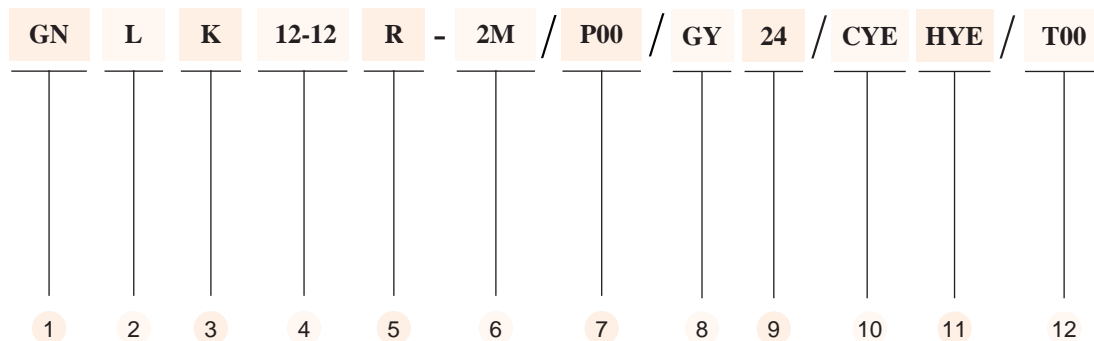

1 GN M23x1连接器\_内螺纹  
GW M23x1连接器\_外螺纹

2 Blank 直线型  
L 直角型

3 K 孔座  
Z 针座

4 针脚数  
编号分配 12-11(12针接11线)  
编号分配 12-12(12针接12线)

5 触点分配  
Blank 常规型号  
R 与常规型号针脚排布方向相反

6 线缆长度[m]

7 线缆材质代码  
参考线缆型号说明

8 线缆颜色  
Blank 6-8针 标准色 橙色  
12-19针 标准色 黑色  
GY 灰色  
YE 黄色

9 电缆线规  
Blank 标准线规 6-7针14AWG,  
12-11,12-12(18AWG),  
19-11(3\*18+8\*22AWG),  
19-19(3\*18+16\*22AWG)  
24 24AWG

10 针托颜色  
Blank 标准色6-9针黑色  
12-19针白色  
CYE 黄色针托

11 预铸接头颜色  
Blank 标准色黑色  
HYE 黄色预铸接头

12 特殊规格定制

## 双端预铸连接器型号说明



GNK12-11 GNZ12-11-2M/P00

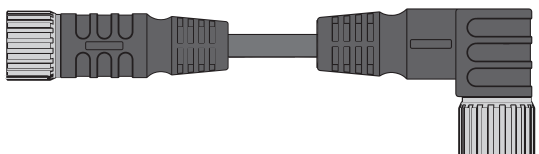

GNK12-11 GNLZ12-11-2M/P00

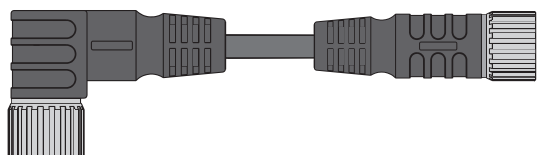

GNLK12-11 GNZ12-11-2M/P00

## 法兰连接器命名规则

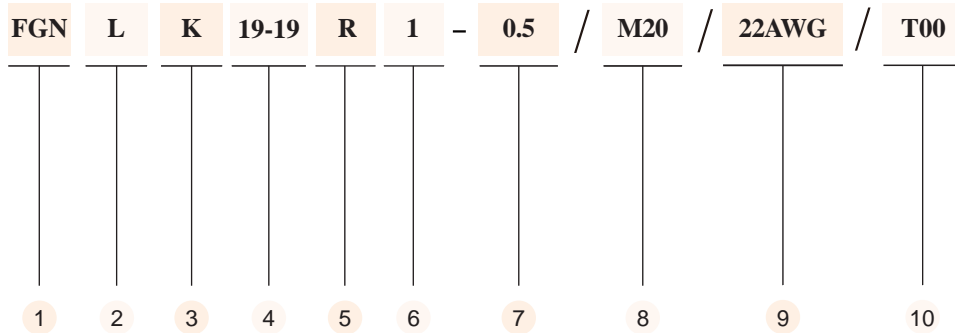

- |  |   |  |
|--|---|--|
| <p>1 FGN M23x1连接器_内螺纹<br/>FGW M23x1连接器_外螺纹</p> <p>2 Blank 直头<br/>L 弯头</p> <p>3 K 孔座<br/>Z 针座</p> <p>4 针脚数<br/>6 (6针, 方型螺钉连接)<br/>8 (8针, 方型螺钉连接)<br/>17 (17针, 方型螺钉连接)<br/>12-11 (12针接11线)<br/>19-19 (19针接19线)</p> | <p>5 针脚方向<br/>Blank 常规型号<br/>R 与常规型号针脚排布相反</p> <p>6 连接方式<br/>Blank 方型螺钉连接<br/>1 前端拧紧型<br/>2 后端拧紧型</p> <p>7 0.5 尾线长度 0.5m<br/>L 导线焊接触点<br/>C 冷压接连接</p> | <p>8 连接螺纹规格<br/>M20 M20X1.5<br/>RS19.8 方形螺钉链接<br/>RF19.8 方形螺钉链接,外壳无凸台<br/>其他规格可定制</p> <p>9 线规<br/>Blank 6-7针 14AWG,12针 18AWG<br/>19针 3x18AWG+16x22AWG</p> <p>10 特殊规格定制</p> |
|--|---|--|

## 现场可接线连接器命名规则

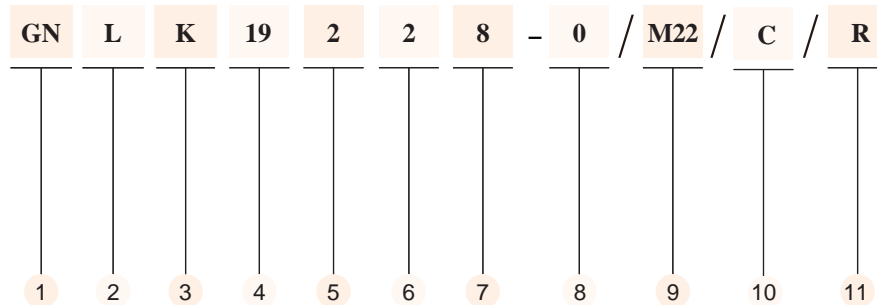

- |   |   |   |
|---|---|---|
| <p>1 GN M23x1连接器_内螺纹<br/>GW M23x1连接器_外螺纹</p> <p>2 Blank 直线型<br/>L 直角型</p> <p>3 K 孔座<br/>Z 针座</p> <p>4 针脚数<br/>6 6针<br/>8 8针<br/>9 9针<br/>12 12针<br/>17 17针<br/>19 19针</p> | <p>5 触点材质<br/>1 铜合金镀银<br/>2 铜合金镀金</p> <p>6 Blank A-CODE(12,17,19针)<br/>2 6, 8 针用<br/>6 9 针用</p> <p>7 外壳材质<br/>8 全金属外壳</p> <p>8 输出方式<br/>0:单输出口<br/>1:双输出口</p> | <p>9 电缆接口<br/>M22<br/>M24<br/>M25</p> <p>10 连接方式<br/>Blank 螺钉连接<br/>C 压接连接<br/>L 焊接连接</p> <p>11 针脚方向<br/>Blank 普通型号<br/>R 和普通型号针脚排布相反</p> |
|---|---|---|

## 6针/8针M23预铸式电源连接器

- 预铸接头:TPU材质,黑色
- 锁紧螺母:锌合金镀镍
- 针托:PA6材质,黑色
- 触点:黄铜镀金
- 密封圈:NBR
- 防护等级:IP67
- 电流等级:6针:18A/8针:30A(1-4针);8A(A-D针)
- 电压等级:6针:630V/8针:630V(1-4针);250V(A-D针)
- 绝缘电阻: $\geq 10^9 \Omega$
- 接触电阻: $\leq 5m\Omega$
- 污染等级:3
- 使用环境温度:-25~+80°C
- 可插拔寿命:最小100次
- 电缆最大外径:13mm



预铸式连接器	型号	订货号	电缆	针脚编号分布
直线孔座 GNK..** 	GNK6-6-2M/P10 GNK6-6-5M/P10 GNK6-6-10M/P10	10057201 10095142 10052976	橙色PUR电缆 4X16 AWG+2X17 AWG (4x1.5mm <sup>2</sup> +2X1.0 mm <sup>2</sup> ) Ø11.2mm 电缆型号: 58556761-*M	孔座 1. L1 2. L2 3. GN/YE 4. L3 5. BK 6. WH
直角孔座 GNLK..** 	GNLK6-6-2M/P10	10057211		1. L1 2. L2 3. GN/YE 4. L3 5. BK 6. WH
直线针座 GWZ..** 	GWZ6-6-2M/P10 GWZ6-6-5M/P10 GWZ6-6-10M/P10	10057202 10095148 10052977	橙色PUR电缆 4X16 AWG+2X17 AWG (4x1.5mm <sup>2</sup> +2X1.0 mm <sup>2</sup> ) Ø11.2mm 电缆型号: 58556761-*M	针座 1. L1 2. L2 3. GN/YE 4. L3 5. BK 6. WH
直角针座 GWLZ..** 	GWLZ6-6-2M/P10	10057224		1. L1 2. L2 3. GN/YE 4. L3 5. BK 6. WH
直线孔座 GNK..** 	GNK8-8-5M/P10 GNK8-8-10M/P10	10095147 10052975	橙色PUR电缆 4X16 AWG+2X2X 18AWG (4x1.5mm <sup>2</sup> +2X2X 0.75mm <sup>2</sup> ) Ø12.8mm 电缆型号: 58545761-*M	孔座 1. L1 2. GN/YE 3. L2 4. L3 A. BK5 B. BK6 C. BK7 D. BK8
直角孔座 GNLK..** 	GNLK8-8-2M/P10	10057212		1. L1 2. GN/YE 3. L2 4. L3 A. BK5 B. BK6 C. BK7 D. BK8
直线针座 GWZ..** 	GWZ8-8-2M/P10	10057223	橙色PUR电缆 4X16 AWG+2X2X 18AWG (4x1.5mm <sup>2</sup> +2X2X 0.75mm <sup>2</sup> ) Ø12.8mm 电缆型号: 58545761-*M	针座 1. L1 2. GN/YE 3. L2 4. L3 A. BK5 B. BK6 C. BK7 D. BK8
直角针座 GWLZ..** 	GWLZ8-8-2M/P10	10057225		1. L1 2. GN/YE 3. L2 4. L3 A. BK5 B. BK6 C. BK7 D. BK8

\* 标准长度为2/5/10米,可订制任意长度

\*\* 标准锁紧螺母材质为黄铜镀镍

## 12针-11芯-12芯M23预铸式连接器

- 预铸接头:TPU材质,黑色
- 锁紧螺母:锌合金镀镍
- 针托:PBT材质,白色
- 触点:黄铜镀银
- 密封圈:NBR
- 防护等级:IP67
- 电流等级:6A
- 电压等级:300V
- 绝缘电阻: $\geq 10^9 \Omega$
- 接触电阻: $\leq 5m\Omega$
- 污染等级:3
- 使用环境温度: $-40 \sim +80^\circ\text{C}$
- 可插拔寿命:最小100次
- 电缆最大外径: 14mm



预铸式连接器	型号	订货号	电缆	针脚编号分布
直线孔座GNK..** 	GNK12-11-2M/P00 GNK12-11-5M/P00 GNK12-11-10M/P00	10050110 10052232 10052001	黑色PVC电缆 11x18AWG (11x0.75mm <sup>2</sup> ) Ø10 mm 电缆型号: 58092911-*M	孔座 <ol style="list-style-type: none"> <li>1. WH</li> <li>2. GN(BN/BU)</li> <li>3. YE</li> <li>4. GY</li> <li>5. PK</li> <li>6. RD</li> <li>7. BK</li> <li>8. VT</li> <li>9. BU</li> <li>10. BU</li> <li>11. BN</li> <li>12. GN/YE (BN/RD)</li> </ol>
直角孔座GNLK..** 	GNLK12-11-2M/P00 GNLK12-11-5M/P00 GNLK12-11-10M/P00	10050100 10050101 10050102		
直线针座GNZ..** 	GNZ12-11-2M/P00 GNZ12-11-5M/P00 GNZ12-11-10M/P00	10050117 10052066 10052067		
直角针座GNLZ..** 	GNLZ12-11-2M/P00 GNLZ12-11-5M/P00 GNLZ12-11-10M/P00	10052030 10052076 10052077		针座 <ol style="list-style-type: none"> <li>1. WH</li> <li>2. GN(BN/BU)</li> <li>3. YE</li> <li>4. GY</li> <li>5. PK</li> <li>6. RD</li> <li>7. BK</li> <li>8. VT</li> <li>9. BU</li> <li>10. BU</li> <li>11. BN</li> <li>12. GN/YE (BN/RD)</li> </ol>
直线孔座GNK..** 	GNK12-12-2M/P00 GNK12-12-5M/P00 GNK12-12-10M/P00	10050172 10052039 10050140	黑色PVC电缆 12x18AWG (12x0.75mm <sup>2</sup> ) Ø10.5mm 电缆型号: 58116911-*M	孔座 <ol style="list-style-type: none"> <li>1. BN</li> <li>2. BU</li> <li>3. WH</li> <li>4. BN/RD</li> <li>5. OG</li> <li>6. YE</li> <li>7. GY</li> <li>8. PK</li> <li>9. RD</li> <li>10. BN/WH</li> <li>11. BU/WH</li> <li>12. GN/WH</li> </ol>
直角孔座GNLK..** 	GNLK12-12-2M/P00 GNLK12-12-5M/P00 GNLK12-12-10M/P00	10050189 10050190 10050191		
直线针座GNZ..** 	GNZ12-12-2M/P00 GNZ12-12-5M/P00 GNZ12-12-10M/P00	10052068 10052055 10052054		
直角针座GNLZ..** 	GNLZ12-12-2M/P00 GNLZ12-12-5M/P00 GNLZ12-12-10M/P00	10052078 10052079 10052086		针座 <ol style="list-style-type: none"> <li>1. BN</li> <li>2. BU</li> <li>3. WH</li> <li>4. BN/RD</li> <li>5. OG</li> <li>6. YE</li> <li>7. GY</li> <li>8. PK</li> <li>9. RD</li> <li>10. BN/WH</li> <li>11. BU/WH</li> <li>12. GN/WH</li> </ol>

\* 标准长度为2/5/10米,可订制任意长度

\*\* 标准锁紧螺母材质为黄铜镀镍

# 17针/19针M23预铸式连接器

- 预铸接头:TPU材质,黑色
- 锁紧螺母:黄铜镀镍
- 针托:TPU材质,白色
- 触点:黄铜镀银
- 密封圈:NBR
- 防护等级:IP67
- 电流等级:9A(18AWG)  
2A(22AWG)
- 电压等级:150V
- 接触电阻: $\geq 10^\circ\Omega$
- 正向电阻: $\leq 5m\Omega$
- 污染等级:3
- 使用环境温度:-40~+80°C
- 可插拔寿命:最小100次
- 电缆最大外径: 14mm



预铸式连接器	型号	订货号	电缆	针脚编号分布
直线孔座GNK...** 	GNK17-17-2M/P00 GNK17-17-5M/P00 GNK17-17-10M/P00	10052051 10052044 10052045	黑色PVC电缆 3x18+16 22AWG (3x0.75+ 16x0.34mm <sup>2</sup> ) Ø10.7mm 电缆型号: 58094911-*M 剪掉VT,GY/BN	孔座 <ol style="list-style-type: none"> <li>1. BU</li> <li>2. RD</li> <li>3. BN</li> <li>4. GY</li> <li>5. GN/YE (BN/RD)</li> <li>6. RD/BU</li> <li>7. GN(BN/BU)</li> <li>8. GY/PK</li> <li>9. WH/GN</li> <li>10. WH/YE</li> <li>11. WH/GY</li> <li>12. BK</li> <li>13. YE/BN</li> <li>14. BN/GN</li> <li>15. WH</li> <li>16. YE</li> <li>17. PK</li> </ol>
直角孔座GNLK...** 	GNLK17-17-2M/P00 GNLK17-17-5M/P00 GNLK17-17-10M/P00	10052047 10052060 10052049	黑色PVC电缆 3x18+16 22AWG (3x0.75+ 16x0.34mm <sup>2</sup> ) Ø10.7mm 电缆型号: 58094911-*M 剪掉VT,GY/BN	针座 <ol style="list-style-type: none"> <li>1. BU</li> <li>2. RD</li> <li>3. BN</li> <li>4. GY</li> <li>5. GN/YE (BN/RD)</li> <li>6. RD/BU</li> <li>7. GN(BN/BU)</li> <li>8. GY/PK</li> <li>9. WH/GN</li> <li>10. WH/YE</li> <li>11. WH/GY</li> <li>12. BK</li> <li>13. YE/BN</li> <li>14. BN/GN</li> <li>15. WH</li> <li>16. YE</li> <li>17. PK</li> </ol>
直线针座GNZ...** 	GNZ17-17-2M/P00 GNZ17-17-5M/P00 GNZ17-17-10M/P00	10052080 10052081 10052082	黑色PVC电缆 3x18+16 22AWG (3x0.75+ 16x0.34mm <sup>2</sup> ) Ø10.7mm 电缆型号: 58094911-*M 剪掉VT,GY/BN	孔座 <ol style="list-style-type: none"> <li>1. BU</li> <li>2. RD</li> <li>3. BN</li> <li>4. GY</li> <li>5. GN/YE (BN/RD)</li> <li>6. RD/BU</li> <li>7. GN(BN/BU)</li> <li>8. GY/PK</li> <li>9. WH/GN</li> <li>10. WH/YE</li> <li>11. WH/GY</li> <li>12. BK</li> <li>13. YE/BN</li> <li>14. BN/GN</li> <li>15. WH</li> <li>16. YE</li> <li>17. PK</li> </ol>
直角针座GNLZ...** 	GNLZ17-17-2M/P00 GNLZ17-17-5M/P00 GNLZ17-17-10M/P00	10050130 10052090 10052091	黑色PVC电缆 3x18+16 22AWG (3x0.75+ 16x0.34mm <sup>2</sup> ) Ø10.7mm 电缆型号: 58094911-*M 剪掉VT,GY/BN	针座 <ol style="list-style-type: none"> <li>1. BU</li> <li>2. RD</li> <li>3. BN</li> <li>4. GY</li> <li>5. GN/YE (BN/RD)</li> <li>6. RD/BU</li> <li>7. GN(BN/BU)</li> <li>8. GY/PK</li> <li>9. WH/GN</li> <li>10. WH/YE</li> <li>11. WH/GY</li> <li>12. BK</li> <li>13. YE/BN</li> <li>14. BN/GN</li> <li>15. WH</li> <li>16. YE</li> <li>17. PK</li> </ol>
直线孔座GNK...** 	GNK19-11-2M/P00 GNK19-11-5M/P00 GNK19-11-10M/P00	10052100 10052102 10052395	黑色PVC电缆 3x18+8x22AWG (3x0.75+ 8x0.34mm <sup>2</sup> ) Ø10.5mm 电缆型号: 58096913-*M	孔座 <ol style="list-style-type: none"> <li>1. N/C</li> <li>2. N/C</li> <li>3. GY</li> <li>4. RD/BU</li> <li>5. GN(BN/BU)</li> <li>6. BU</li> <li>7. GY/PK</li> <li>8. WH/GN</li> <li>9. N/C</li> <li>10. N/C</li> <li>11. N/C</li> <li>12. GN/YE (BN/RD)</li> <li>13. N/C</li> <li>14. BN/GN</li> <li>15. WH</li> <li>16. YE</li> <li>18. N/C</li> <li>17. N/C</li> <li>19. BN</li> </ol>
直角孔座GNLK...** 	GNLK19-11-2M/P00 GNLK19-11-5M/P00 GNLK19-11-10M/P00	10052120 10052123 10052121	黑色PVC电缆 3x18+8*22AWG (3x0.75+ 8x0.34mm <sup>2</sup> ) Ø10.5mm 电缆型号: 58096913-*M	针座 <ol style="list-style-type: none"> <li>1. N/C</li> <li>2. N/C</li> <li>3. GY</li> <li>4. RD/BU</li> <li>5. GN(BN/BU)</li> <li>6. BU</li> <li>7. GY/PK</li> <li>8. WH/GN</li> <li>9. N/C</li> <li>10. N/C</li> <li>11. N/C</li> <li>12. GN/YE (BN/RD)</li> <li>13. N/C</li> <li>14. BN/GN</li> <li>15. WH</li> <li>16. YE</li> <li>18. N/C</li> <li>17. N/C</li> <li>19. BN</li> </ol>
直线针座GNZ...** 	GNZ19-11-2M/P00 GNZ19-11-5M/P00 GNZ19-11-10M/P00	10052110 10052112 10052113	黑色PVC电缆 3x18+8*22AWG (3x0.75+ 8x0.34mm <sup>2</sup> ) Ø10.5mm 电缆型号: 58096913-*M	孔座 <ol style="list-style-type: none"> <li>1. N/C</li> <li>2. N/C</li> <li>3. GY</li> <li>4. RD/BU</li> <li>5. GN(BN/BU)</li> <li>6. BU</li> <li>7. GY/PK</li> <li>8. WH/GN</li> <li>9. N/C</li> <li>10. N/C</li> <li>11. N/C</li> <li>12. GN/YE (BN/RD)</li> <li>13. N/C</li> <li>14. BN/GN</li> <li>15. WH</li> <li>16. YE</li> <li>18. N/C</li> <li>17. N/C</li> <li>19. BN</li> </ol>
直角针座GNLZ...** 	GNLZ19-11-2M/P00 GNLZ19-11-5M/P00 GNLZ19-11-10M/P00	10052130 10052131 10052132	黑色PVC电缆 3x18+8*22AWG (3x0.75+ 8x0.34mm <sup>2</sup> ) Ø10.5mm 电缆型号: 58096913-*M	针座 <ol style="list-style-type: none"> <li>1. N/C</li> <li>2. N/C</li> <li>3. GY</li> <li>4. RD/BU</li> <li>5. GN(BN/BU)</li> <li>6. BU</li> <li>7. GY/PK</li> <li>8. WH/GN</li> <li>9. N/C</li> <li>10. N/C</li> <li>11. N/C</li> <li>12. GN/YE (BN/RD)</li> <li>13. N/C</li> <li>14. BN/GN</li> <li>15. WH</li> <li>16. YE</li> <li>18. N/C</li> <li>17. N/C</li> <li>19. BN</li> </ol>

\* 标准长度为2/5/10米,可订制任意长度

\*\* 标准锁紧螺母材质为黄铜镀镍

## 19针M23预铸式连接器

- 预铸接头:TPU材质,黑色
- 锁紧螺母:黄铜镀镍
- 针托:TPU材质,白色
- 触点:黄铜镀银
- 密封圈:NBR
- 防护等级:IP67
- 电流等级:9A(18AWG)  
2A(22AWG)
- 电压等级:150V
- 绝缘电阻: $\geq 10^9 \Omega$
- 接触电阻: $\leq 5m\Omega$
- 污染等级:3
- 使用环境温度:-40~+80°C
- 可插拔寿命:最小100次
- 电缆最大外径: 14mm



预铸式连接器	型号	订货号	电缆	针脚编号分布
直线孔座GNK..** 	GNK19-15-2M/P00 GNK19-15-5M/P00 GNK19-15-10M/P00	10052390 10052391 10052392	黑色PVC电缆 3x18+12*22AWG (3x0.75+ 12x0.34mm <sup>2</sup> ) Ø10mm 电缆型号: 58028151-*M	孔座 <ol style="list-style-type: none"> <li>1. N/C</li> <li>2. RD</li> <li>3. GY</li> <li>4. RD/BU</li> <li>5. GN(BN/BU)</li> <li>6. BU</li> <li>7. GY/PK</li> <li>8. WH/GN</li> <li>9. WH/YE</li> <li>10. N/C</li> <li>11. N/C</li> <li>12. GN/YE (BN/RD)</li> <li>13. YE/BN</li> <li>14. BN/GN</li> <li>15. WH</li> <li>16. YE</li> <li>18. N/C</li> <li>17. PK</li> <li>19. BN</li> </ol>
直角孔座GNLK..** 	GNLK19-15-2M/P00 GNLK19-15-5M/P00 GNLK19-15-10M/P00	10052400 10052401 10052402		
直线针座GNZ..** 	GNZ19-15-2M/P00 GNZ19-15-5M/P00 GNZ19-15-10M/P00	10052420 10052421 10052422	黑色PVC电缆 3x18+12*22AWG (3x0.75+ 12x0.34mm <sup>2</sup> ) Ø10mm 电缆型号: 58028151-*M	针座 <ol style="list-style-type: none"> <li>1. N/C</li> <li>2. RD</li> <li>3. GY</li> <li>4. RD/BU</li> <li>5. GN(BN/BU)</li> <li>6. BU</li> <li>7. GY/PK</li> <li>8. WH/GN</li> <li>9. WH/YE</li> <li>10. N/C</li> <li>11. N/C</li> <li>12. GN/YE (BN/RD)</li> <li>13. YE/BN</li> <li>14. BN/GN</li> <li>15. WH</li> <li>16. YE</li> <li>18. N/C</li> <li>17. PK</li> <li>19. BN</li> </ol>
直角针座GNLZ..** 	GNLZ19-15-2M/P00 GNLZ19-15-5M/P00 GNLZ19-15-10M/P00	10052430 10052431 10052432		
直线孔座GNK..** 	GNK19-19-2M/P00 GNK19-19-5M/P00 GNK19-19-10M/P00	10050148 10050149 10052228	黑色PVC电缆 3x18+16*22AWG (3x0.75+ 16x0.34mm <sup>2</sup> ) Ø10.7mm 电缆型号: 58094911-*M	孔座 <ol style="list-style-type: none"> <li>1. VT</li> <li>2. RD</li> <li>3. GY</li> <li>4. RD/BU</li> <li>5. GN(BN/BU)</li> <li>6. BU</li> <li>7. GY/PK</li> <li>8. WH/GN</li> <li>9. WH/YE</li> <li>10. WH/GY</li> <li>11. BK</li> <li>12. GN/YE (BN/RD)</li> <li>13. YE/BN</li> <li>14. BN/GN</li> <li>15. WH</li> <li>16. YE</li> <li>18. GY/BN</li> <li>17. PK</li> <li>19. BN</li> </ol>
直角孔座GNLK..** 	GNLK19-19-2M/P00 GNLK19-19-5M/P00 GNLK19-19-10M/P00	10050500 10050501 10052221		
直线针座GNZ..** 	GNZ19-19-2M/P00 GNZ19-19-5M/P00 GNZ19-19-10M/P00	10052210 10052211 10052237	黑色PVC电缆 3x18+16*22AWG (3x0.75+ 16x0.34mm <sup>2</sup> ) Ø10.7mm 电缆型号: 58094911-*M	针座 <ol style="list-style-type: none"> <li>1. VT</li> <li>2. RD</li> <li>3. GY</li> <li>4. RD/BU</li> <li>5. GN(BN/BU)</li> <li>6. BU</li> <li>7. GY/PK</li> <li>8. WH/GN</li> <li>9. WH/YE</li> <li>10. WH/GY</li> <li>11. BK</li> <li>12. GN/YE (BN/RD)</li> <li>13. YE/BN</li> <li>14. BN/GN</li> <li>15. WH</li> <li>16. YE</li> <li>18. GY/BN</li> <li>17. PK</li> <li>19. BN</li> </ol>
直角针座GNLZ..** 	GNLZ19-19-2M/P00 GNLZ19-19-5M/P00 GNLZ19-19-10M/P00	10052230 10052242 10052263		

\* 标准长度为2/5/10米,可订制任意长度

\*\* 标准锁紧螺母材质为黄铜镀镍

# 12针/17针/19针M23预铸式连接器

- 预铸接头:TPU材质,黑色
- 锁紧螺母:黄铜镀镍
- 针托:TPU材质,白色
- 触点:黄铜镀银
- 密封圈:NBR
- 防护等级:IP67
- 电流等级:12针6A\19针9A (18AWG) , 2A (22AWG)
- 电压等级:12针300V\19针150V
- 绝缘电阻: $\geq 10^9 \Omega$
- 接触电阻: $\leq 5m\Omega$
- 污染等级:3
- 使用环境温度:-40~+80°C
- 可插拔寿命:最小100次
- 电缆最大外径: 14mm



预铸式连接器	型号	订货号	电缆	针脚编号分布
直线针座GWZ..** 	GWZ12-11-2M/P00 GWZ12-11-5M/P00 GWZ12-11-10M/P00	10052069 10052074 10052075	黑色PVC电缆 11x18AWG (11x0.75mm <sup>2</sup> ) Ø10.0mm 电缆型号: 58092911-*M	针座 <ol style="list-style-type: none"> <li>1. WH</li> <li>2. GN(BN/BU)</li> <li>3. YE</li> <li>4. GY</li> <li>5. PK</li> <li>6. RD</li> <li>7. BK</li> <li>8. VT</li> <li>9. BU</li> <li>10. BU</li> <li>11. BN</li> <li>12. GN/YE (BN/RD)</li> </ol>
直角针座GWLZ..** 	GWLZ12-11-2M/P00 GWLZ12-11-5M/P00 GWLZ12-11-10M/P00	10052456 10052457 10052459	黑色PVC电缆 12x18AWG (12x0.75mm <sup>2</sup> ) Ø10.5mm 电缆型号: 58116911-*M	针座 <ol style="list-style-type: none"> <li>1. BN</li> <li>2. BU</li> <li>3. WH</li> <li>4. BN/RD</li> <li>5. OG</li> <li>6. YE</li> <li>7. GY</li> <li>8. PK</li> <li>9. RD</li> <li>10. BN/WH</li> <li>11. BU/WH</li> <li>12. GN/WH</li> </ol>
直线针座GWZ..** 	GWZ12-12-2M/P00 GWZ12-12-5M/P00 GWZ12-12-10M/P00	10052010 10052087 10052088	黑色PVC电缆 12x18AWG (12x0.75mm <sup>2</sup> ) Ø10.5mm 电缆型号: 58116911-*M	针座 <ol style="list-style-type: none"> <li>1. BU</li> <li>2. RD</li> <li>3. BN</li> <li>4. GY</li> <li>5. GN/YE (BN/RD)</li> <li>6. RD/BU</li> <li>7. GN (BN/BU)</li> <li>8. GY/PK</li> <li>9. WH/GN</li> <li>10. WH/YE</li> <li>11. WH/GY</li> <li>12. BK</li> <li>13. YE/BN</li> <li>14. BN/GN</li> <li>15. WH</li> <li>16. YE</li> <li>17. PK</li> </ol>
直角针座GWLZ..** 	GWLZ12-12-2M/P00 GWLZ12-12-5M/P00 GWLZ12-12-10M/P00	10052463 10052464 10052465	黑色PVC电缆 3x18+16*22AWG (3x0.75+ 16x0.34mm <sup>2</sup> ) Ø10.7mm 电缆型号: 58094911-*M 剪掉VT,GY,BN	针座 <ol style="list-style-type: none"> <li>1. N/C</li> <li>2. N/C</li> <li>3. GY</li> <li>4. RD/BU</li> <li>5. GN(BN/BU)</li> <li>6. BU</li> <li>7. GY/PK</li> <li>8. WH/GN</li> <li>9. N/C</li> <li>10. N/C</li> <li>11. N/C</li> <li>12. GN/YE (BN/RD)</li> <li>13. N/C</li> <li>14. BN/GN</li> <li>15. WH</li> <li>16. YE</li> <li>18. N/C</li> <li>19. BN</li> </ol>
直线针座GWZ..** 	GWZ17-17-2M/P00 GWZ17-17-5M/P00 GWZ17-17-10M/P00	10052440 10052441 10052442	黑色PVC电缆 3x18+16*22AWG (3x0.75+ 16x0.34mm <sup>2</sup> ) Ø10.7mm 电缆型号: 58094911-*M 剪掉VT,GY,BN	针座 <ol style="list-style-type: none"> <li>1. N/C</li> <li>2. N/C</li> <li>3. GY</li> <li>4. RD/BU</li> <li>5. GN(BN/BU)</li> <li>6. BU</li> <li>7. GY/PK</li> <li>8. WH/GN</li> <li>9. N/C</li> <li>10. N/C</li> <li>11. N/C</li> <li>12. GN/YE (BN/RD)</li> <li>13. N/C</li> <li>14. BN/GN</li> <li>15. WH</li> <li>16. YE</li> <li>18. N/C</li> <li>19. BN</li> </ol>
直角针座GWLZ..** 	GWLZ17-17-2M/P00 GWLZ17-17-5M/P00 GWLZ17-17-10M/P00	10052450 10052451 10052452	黑色PVC电缆 3x18+8*22AWG (3x0.75+ 8x0.34mm <sup>2</sup> ) Ø10.5mm 电缆型号: 58096913-*M	针座 <ol style="list-style-type: none"> <li>1. N/C</li> <li>2. N/C</li> <li>3. GY</li> <li>4. RD/BU</li> <li>5. GN(BN/BU)</li> <li>6. BU</li> <li>7. GY/PK</li> <li>8. WH/GN</li> <li>9. N/C</li> <li>10. N/C</li> <li>11. N/C</li> <li>12. GN/YE (BN/RD)</li> <li>13. N/C</li> <li>14. BN/GN</li> <li>15. WH</li> <li>16. YE</li> <li>18. N/C</li> <li>19. BN</li> </ol>

\* 标准长度为2/5/10米,可订制任意长度

\*\* 标准锁紧螺母材质为黄铜镀镍

## 19针/12针、19针分线盒用M23预铸式连接器

- 预铸接头:TPU材质,黑色
- 锁紧螺母:黄铜镀镍
- 针托:TPU材质,白色
- 触点:黄铜镀银
- 密封圈:NBR
- 防护等级:IP67
- 电流等级:12针6A, 19针9A(18AWG)、2A(22AWG)
- 电压等级:12针300V, 19针150V
- 绝缘电阻: $\geq 10^9 \Omega$
- 接触电阻: $\leq 5m\Omega$
- 污染等级:3
- 使用环境温度: $-40 \sim +80^\circ\text{C}$
- 可插拔寿命:最小100次
- 电缆最大外径: 14mm



预铸式连接器	型号	订货号	电缆	针脚编号分布
<b>直线针座GWZ..**</b> 	GWZ19-19-2M/P00 GWZ19-19-5M/P00 GWZ19-19-10M/P00	10052036 10052016 10052040	黑色PVC电缆 3x18AWG+ 16x22AWG (3x0.75mm <sup>2</sup> + 16x0.34mm <sup>2</sup> ) Ø10.7mm 电缆型号: 58094911-*M	<b>针座</b>  1. VT 2. RD 3. GY 4. RD/BU 5. GN(BN/BU) 6. BU 7. GY/PK 8. WH/GN 9. WH/YE 10. WH/GY 11. BK 12. GN/YE (BN/RD) 13. YE/BN 14. BN/GN 15. WH 16. YE 18. GY/BN 17. PK 19. BN
<b>直角针座GWLZ..**</b> 	GWLZ19-19-2M/P00 GWLZ19-19-5M/P00 GWLZ19-19-10M/P00	10052035 10052034 10052640	黑色PVC电缆 7x18AWG (7x0.75mm <sup>2</sup> ) Ø8.8mm 电缆型号: 58030151-*M (对插分线盒型号: JB4M12-4P-T)	<b>孔座</b>  1. WH 2. GN(BN/BU) 3. YE 4. GY 5. N/C 6. N/C 7. N/C 8. N/C 9. BU 10. BU 11. BN 12. GN/YE (BN/RD)
<b>直线孔座GNK..**</b> 	GNK12-7-2M/P00 GNK12-7-5M/P00 GNK12-7-10M/P00	10052269 10052233 10052234	黑色PVC电缆 9x18AWG (9x0.75mm <sup>2</sup> ) Ø10.0mm 电缆型号: 58031151-*M (对插分线盒型号: JB6M12-4P-T)	<b>孔座</b>  1. WH 2. GN(BN/BU) 3. YE 4. GY 5. N/C 6. N/C 7. N/C 8. N/C 9. BU 10. BU 11. BN 12. GN/YE (BN/RD)
<b>直角孔座GNLK..**</b> 	GNLK12-7-2M/P00 GNLK12-7-5M/P00 GNLK12-7-10M/P00	10093244 10093245 10093246	黑色PVC电缆 9x18AWG (9x0.75mm <sup>2</sup> ) Ø10.0mm 电缆型号: 58031151-*M (对插分线盒型号: JB6M12-4P-T)	<b>孔座</b>  1. WH 2. GN(BN/BU) 3. YE 4. GY 5. PK 6. RD 7. N/C 8. N/C 9. BU 10. BU 11. BN 12. GN/YE (BN/RD)
<b>直线孔座GNK..**</b> 	GNK12-9-2M/P00 GNK12-9-5M/P00 GNK12-9-10M/P00	10093247 10093248 10093249	黑色PVC电缆 2*20+12*24AWG (2x0.5+ 12x0.25mm <sup>2</sup> ) Ø8.5mm 电缆型号: 58099911-*M (对插分线盒型号: JBW12M8-3P-T)	<b>孔座</b>  1. WH 2. GN(BN/BU) 3. YE 4. GY 5. PK 6. BU 7. RD 8. BK 9. VT 10. GY/PK 11. RD/BU 12. N/C 13. WH/GN 14. BN/GN 15. N/C 16. N/C 18. N/C 17. N/C 19. BN
<b>直角孔座GNLK..**</b> 	GNLK19-14-2M/P00 GNLK19-14-5M/P00 GNLK19-14-10M/P00	10050171 10052770 10052642	黑色PVC电缆 2*20+12*24AWG (2x0.5+ 12x0.25mm <sup>2</sup> ) Ø8.5mm 电缆型号: 58099911-*M (对插分线盒型号: JBW12M8-3P-T)	<b>孔座</b>  1. WH 2. GN(BN/BU) 3. YE 4. GY 5. PK 6. BU 7. RD 8. BK 9. VT 10. GY/PK 11. RD/BU 12. N/C 13. WH/GN 14. BN/GN 15. N/C 16. N/C 18. N/C 17. N/C 19. BN

\* 标准长度为2/5/10米,可订制任意长度

\*\* 标准锁紧螺母材质为黄铜镀镍

## 12针M23预铸式连接器(R反向)

- 预铸接头:TPU材质,黑色
- 锁紧螺母:黄铜镀镍
- 针托:TPU材质,白色
- 触点:黄铜镀银
- 密封圈:NBR
- 防护等级:IP67
- 电流等级:6A
- 电压等级:300V
- 绝缘电阻: $\geq 10^9 \Omega$
- 接触电阻: $\leq 5m\Omega$
- 污染等级:3
- 使用环境温度: $-40 \sim +80^\circ\text{C}$
- 可插拔寿命:最小100次
- 电缆最大外径: 14mm



预铸式连接器	型号	订货号	电缆	针脚编号分布
直线孔座GWK..** 	GWK12-12R-2M/P00 GWK12-12R-5M/P00 GWK12-12R-10M/P00	10093254 10093255 10093256	黑色PVC电缆 12x18AWG (12x0.75mm <sup>2</sup> ) Ø10.5mm 电缆型号: 58116911-*M	孔座 <ol style="list-style-type: none"> <li>1. BN</li> <li>2. BU</li> <li>3. WH</li> <li>4. BN/RD</li> <li>5. OG</li> <li>6. YE</li> <li>7. GY</li> <li>8. PK</li> <li>9. RD</li> <li>10. BN/WH</li> <li>11. BU/WH</li> <li>12. GN/WH</li> </ol>
直角孔座GWLK..** 	GWLK12-12R-2M/P00 GWLK12-12R-5M/P00 GWLK12-12R-10M/P00	10093257 10093258 10093259		针座 <ol style="list-style-type: none"> <li>1. BN</li> <li>2. BU</li> <li>3. WH</li> <li>4. BN/RD</li> <li>5. OG</li> <li>6. YE</li> <li>7. GY</li> <li>8. PK</li> <li>9. RD</li> <li>10. BN/WH</li> <li>11. BU/WH</li> <li>12. GN/WH</li> </ol>
直线针座GWZ..** 	GWZ12-12R-2M/P00 GWZ12-12R-5M/P00 GWZ12-12R-10M/P00	10052702 10052703 10052704	黑色PVC电缆 12x18AWG (12x0.75mm <sup>2</sup> ) Ø10.5mm 电缆型号: 58116911-*M	孔座 <ol style="list-style-type: none"> <li>1. BN</li> <li>2. BU</li> <li>3. WH</li> <li>4. BN/RD</li> <li>5. OG</li> <li>6. YE</li> <li>7. GY</li> <li>8. PK</li> <li>9. RD</li> <li>10. BN/WH</li> <li>11. BU/WH</li> <li>12. GN/WH</li> </ol>
直角针座GWLZ..** 	GWLZ12-12R-2M/P00 GWLZ12-12R-5M/P00 GWLZ12-12R-10M/P00	10052705 10052706 10052707		针座 <ol style="list-style-type: none"> <li>1. BN</li> <li>2. BU</li> <li>3. WH</li> <li>4. BN/RD</li> <li>5. OG</li> <li>6. YE</li> <li>7. GY</li> <li>8. PK</li> <li>9. RD</li> <li>10. BN/WH</li> <li>11. BU/WH</li> <li>12. GN/WH</li> </ol>
直线孔座GNK..** 	GNK12-12R-2M/P00 GNK12-12R-5M/P00 GNK12-12R-10M/P00	10050188 10050175 10052662	黑色PVC电缆 12x18AWG (12x0.75mm <sup>2</sup> ) Ø10.5mm 电缆型号: 58116911-*M	孔座 <ol style="list-style-type: none"> <li>1. BN</li> <li>2. BU</li> <li>3. WH</li> <li>4. BN/RD</li> <li>5. OG</li> <li>6. YE</li> <li>7. GY</li> <li>8. PK</li> <li>9. RD</li> <li>10. BN/WH</li> <li>11. BU/WH</li> <li>12. GN/WH</li> </ol>
直角孔座GNLK..** 	GNLK12-12R-2M/P00 GNLK12-12R-5M/P00 GNLK12-12R-10M/P00	10052663 10052664 10052665		针座 <ol style="list-style-type: none"> <li>1. BN</li> <li>2. BU</li> <li>3. WH</li> <li>4. BN/RD</li> <li>5. OG</li> <li>6. YE</li> <li>7. GY</li> <li>8. PK</li> <li>9. RD</li> <li>10. BN/WH</li> <li>11. BU/WH</li> <li>12. GN/WH</li> </ol>
直线针座GNZ..** 	GNZ12-12R-2M/P00 GNZ12-12R-5M/P00 GNZ12-12R-10M/P00	10052666 10052667 10052668	黑色PVC电缆 12x18AWG (12x0.75mm <sup>2</sup> ) Ø10.5mm 电缆型号: 58116911-*M	孔座 <ol style="list-style-type: none"> <li>1. BN</li> <li>2. BU</li> <li>3. WH</li> <li>4. BN/RD</li> <li>5. OG</li> <li>6. YE</li> <li>7. GY</li> <li>8. PK</li> <li>9. RD</li> <li>10. BN/WH</li> <li>11. BU/WH</li> <li>12. GN/WH</li> </ol>
直角针座GNLZ..** 	GNLZ12-12R-2M/P00 GNLZ12-12R-5M/P00 GNLZ12-12R-10M/P00	10052669 10052670 10052671		针座 <ol style="list-style-type: none"> <li>1. BN</li> <li>2. BU</li> <li>3. WH</li> <li>4. BN/RD</li> <li>5. OG</li> <li>6. YE</li> <li>7. GY</li> <li>8. PK</li> <li>9. RD</li> <li>10. BN/WH</li> <li>11. BU/WH</li> <li>12. GN/WH</li> </ol>

\* 标准长度为2/5/10米,可订制任意长度

\*\* 标准锁紧螺母材质为黄铜镀镍

## 12针/17针/19针M23现场可接线连接器



现场可接线连接器	型号	订货号	特性描述	针脚编号分布
M23 直线型 焊接连接  	GNK1228-0/M22/L	10095000	铜锌合金 M22电缆出线口 可连接的电缆外径范围: 6-10mm 焊接连接 85°C, 300 V, 8 A	12芯孔座 
	GNZ1228-0/M22/L	10095011	铜锌合金 M22电缆出线口 可连接的电缆外径范围: 6-10mm 焊接连接 85°C, 300 V, 8 A	12芯针座 
	GNK1728-0/M22/L	10052600	铜锌合金 M22电缆出线口 可连接的电缆外径范围: 6-10mm 焊接连接 85°C, 150 V, 8 A	17芯孔座 
	GNZ1728-0/M22/L	10052611	铜锌合金 M22电缆出线口 可连接的电缆外径范围: 6-10mm 焊接连接 85°C, 150 V, 8 A	17芯针座 
	GNK1928-0/M22/L	10052614	铜锌合金 M22电缆出线口 可连接的电缆外径范围: 6-10mm 焊接连接 85°C, 150 V, 8 A	19芯孔座 
	GNZ1928-0/M22/L	10095021	铜锌合金 M22电缆出线口 可连接的电缆外径范围: 6-10mm 焊接连接 85°C, 150 V, 8 A	19芯针座 

## 12针/17针/19针M23现场可接线连接器

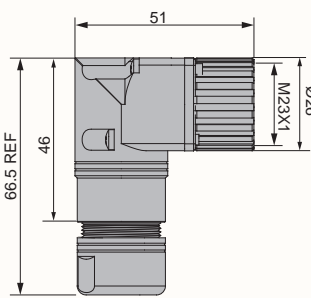
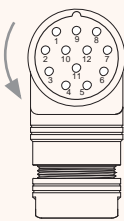
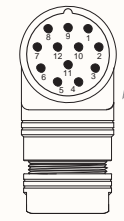
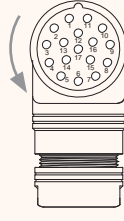
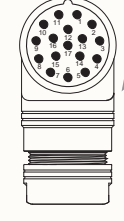
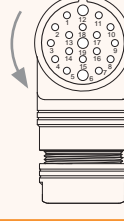
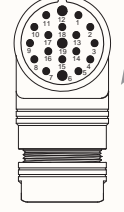

现场可接线连接器	型号	订货号	特性描述	针脚编号分布
M23 直角型 焊接连接  	GNLK1228-0/M22/L	10095029	铜锌合金 M22电缆出线口 可连接的电缆外径范围：6-10mm 焊接连接 85°C, 300 V, 8 A	 12芯孔座
	GNLZ1228-0/M22/L	10095032	铜锌合金 M22电缆出线口 可连接的电缆外径范围：6-10mm 焊接连接 85°C, 300 V, 8 A	 12芯针座
	GNLK1728-0/M22/L	10052612	铜锌合金 M22电缆出线口 可连接的电缆外径范围：6-10mm 焊接连接 85°C, 150 V, 8 A	 17芯孔座
	GNLZ1728-0/M22/L	10095036	铜锌合金 M22电缆出线口 可连接的电缆外径范围：6-10mm 焊接连接 85°C, 150 V, 8 A	 17芯针座
	GNLK1928-0/M22/L	10052613	铜锌合金 M22电缆出线口 可连接的电缆外径范围：6-10mm 焊接连接 85°C, 150 V, 8 A	 19芯孔座
	GNLZ1928-0/M22/L	10095020	铜锌合金 M22电缆出线口 可连接的电缆外径范围：6-10mm 焊接连接 85°C, 150 V, 8 A	 19芯针座



现场可接线连接器	型号	订货号	特性描述	针脚编号分布
M23 直线型 焊接连接  	GWZ1228-0/M22/L	10095009	铜锌合金 M22电缆出线口 可连接的电缆外径范围: 6-10mm 焊接连接 85°C, 300 V, 8 A	12芯针座 
	GWZ1728-0/M22/L	10052690	铜锌合金 M22电缆出线口 可连接的电缆外径范围: 6-10mm 焊接连接 85°C, 150 V, 8 A	17芯针座 
	GWZ1928-0/M22/L	10095012	铜锌合金 M22电缆出线口 可连接的电缆外径范围: 6-10mm 焊接连接 85°C, 150 V, 8 A	19芯针座 

## 12针/17针M23现场可接线连接器(反向)

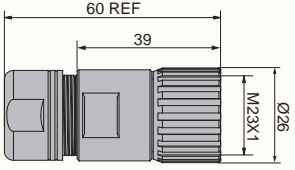
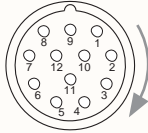
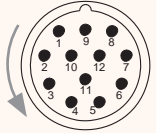
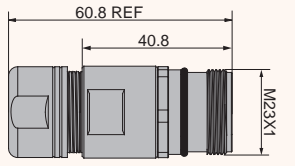
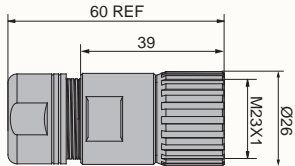
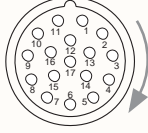
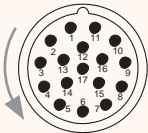
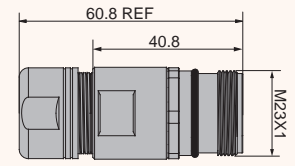

现场可接线连接器	型号	订货号	特性描述	针脚编号分布
M23直线型 焊接连接 反向 	GNK1228-0/M22/L/R	10095017	铜锌合金 M22电缆出线口 可连接的电缆外径范围: 6-10mm 焊接连接 85°C, 300 V, 8 A	12芯孔座 
	GNZ1228-0/M22/L/R	10095037		12芯针座 
M23直线型 焊接连接 反向 	GWZ1228-0/M22/L/R	10095018		
M23直线型 焊接连接 反向 	GNK1728-0/M22/L/R	10052618	铜锌合金 M22电缆出线口 可连接的电缆外径范围: 6-10mm 焊接连接 85°C, 150 V, 8 A	17芯孔座 
	GNZ1728-0/M22/L/R	10052617		17芯针座 
M23直线型 焊接连接 反向 	GWZ1728-0/M22/L/R	10052691		

## 12针/17针M23现场可接线连接器(反向)



现场可接线连接器	型号	订货号	特性描述	针脚编号分布
	GNLK1228-0/M22/L/R	10095039	铜锌合金 M22电缆出线口 可连接的电缆外径范围: 6-10mm 焊接连接 85°C, 300 V, 8 A	 12芯孔座
	GNLZ1228-0/M22/L/R	10095040	铜锌合金 M22电缆出线口 可连接的电缆外径范围: 6-10mm 焊接连接 85°C, 300 V, 8 A	 12芯针座
	GNLK1728-0/M22/L/R	10052622	铜锌合金 M22电缆出线口 可连接的电缆外径范围: 6-10mm 焊接连接 85°C, 150 V, 8 A	 17芯孔座
	GNLZ1728-0/M22/L/R	10052623	铜锌合金 M22电缆出线口 可连接的电缆外径范围: 6-10mm 焊接连接 85°C, 150 V, 8 A	 17芯针座

## 9针M23现场可接线连接器



现场可接线连接器	型号	订货号	特性描述	针脚编号分布
M23 9芯直线型 焊接连接 	GNK9628-0/M22/L	10095023	铜锌合金 M22电缆出线口 可连接的电缆外径范围: 6-10mm 焊接连接 85°C, 9 POS(3+6) 电源: 150 V, 20 A 信号: 150 V, 8 A	孔座 
	GNZ9628-0/M22/L	10095022	铜锌合金 M22电缆出线口 可连接的电缆外径范围: 6-10mm 焊接连接 85°C, 9 POS(3+6) 电源: 150 V, 20 A 信号: 150 V, 8 A	针座 
M23 9芯直线型 焊接连接 	GWZ9628-0/M22/L	10095043	铜锌合金 M22电缆出线口 可连接的电缆外径范围: 6-10mm 焊接连接 85°C 9 POS(3+6) 电源: 150 V, 20 A 信号: 150 V, 8 A	针座 



现场可接线连接器	型号	订货号	特性描述	针脚编号分布
M23 6芯直线型 压接连接 	GNK6228-0/M24/C GNK6228-0/M24/C1	10095004 10095044	外壳材质铜锌合金 可接电缆外径范围:7-12mm, 11-17mm 85°C 630 V 28 A 压接连接: (型号自带6PIN插针) /C 母针型号GK1-2.5-C.6228 可接线芯范围:1~2.5mm <sup>2</sup> /C1 母针型号GK2.5-4-C1.6228 可接线芯范围:2.5~4mm <sup>2</sup>	孔座 
M23 6芯直线型 压接连接 	GWZ6228-0/M24/C GWZ6228-0/M24/C1	10095008 10095105	外壳材质铜锌合金 可接电缆外径范围:7-12mm, 11-17mm 85°C 630 V 28 A 压接连接: (型号自带6PIN插针) /C 公针型号GZ1-2.5-C.6228 可接线芯范围:1~2.5mm <sup>2</sup> /C1 公针型号GZ2.5-4-C1.6228 可接线芯范围:2.5~4mm <sup>2</sup>	针座 
母针	GK1-2.5-C.6228	10093260	可接线芯范围 1~2.5mm <sup>2</sup>	
	GK2.5-4-C1.6228	10093261	可接线芯范围2.5~4mm <sup>2</sup>	
公针	GZ1-2.5-C.6228	10093262	可接线芯范围 1~2.5mm <sup>2</sup>	
	GZ2.5-4-C1.6228	10093263	可接线芯范围 2.5~4mm <sup>2</sup>	

## 8针M23 现场可接线连接器



现场可接线连接器	型号	订货号	特性描述	针脚编号分布
M23 8芯直线型 压接连接 	GNK8228-0/M24/C GNK8228-0/M24/C1	10052571 10052867	外壳材质铜锌合金 可接电缆外径范围: 7-12mm, 11-17mm 85°C (型号自带8PIN插针) 电源: 630 V(粗);250V(细) 20 A(粗);8A(细) 压接连接 /C 母针(粗)型号GK1-2.5-C.8228 母针(细)型号GK0.25-1-C.8228 /C1 母针(粗)型号GK2.5-4-C1.8228 母针(细)型号GK0.75-1.5-C1.8228	孔座 
M23 8芯直线型 压接连接 	GWZ8228-0/M24/C GWZ8228-0/M24/C1	10052572 10052868	外壳材质铜锌合金 可接电缆外径范围: 7-12mm, 11-17mm 85°C (型号自带8PIN插针) 电源: 630 V(粗);250V(细) 20 A(粗);8A(细) 压接连接 /C 公针(粗)型号GZ1-2.5-C.8228 公针(细)型号GZ0.25-1-C.8228 /C1 公针(粗)型号GZ2.5-4-C1.8228 公针(细)型号GZ0.75-1.5-C1.8228	针座 

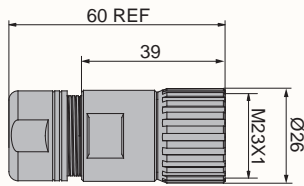

现场可接线连接器	型号	订货号	特性描述	针脚编号分布
M23 直线型 压接连接	GNK1228-0/M22/C	10095028	铜锌合金 M22电缆出线口 可连接的电缆外径范围: 6-10mm 85°C,300V,8A 压接连接: (型号自带12PIN插针)	12芯孔座 
	GNZ1228-0/M22/C	10095126	铜锌合金 M22电缆出线口 可连接的电缆外径范围: 6-10mm 85°C,300V,8A 压接连接: (型号自带12PIN插针)	12芯针座 
	GNK1728-0/M22/C	10095052	铜锌合金 M22电缆出线口 可连接的电缆外径范围: 6-10mm 85°C,150V,8A 压接连接: (型号自带17PIN插针)	17芯孔座 
	GNZ1728-0/M22/C	10095562	铜锌合金 M22电缆出线口 可连接的电缆外径范围: 6-10mm 85°C,150V,8A 压接连接: (型号自带17PIN插针)	17芯针座 
	GNK1928-0/M22/C	10095083	铜锌合金 M22电缆出线口 可连接的电缆外径范围: 6-10mm 85°C 150 V, 9A(粗),2A(细) 压接连接: (型号自带16+3PIN插针)	19芯孔座 
	GNZ1928-0/M22/C	10052837	铜锌合金 M22电缆出线口 可连接的电缆外径范围: 6-10mm 85°C 150 V, 9A(粗),2A(细) 压接连接: (型号自带16+3PIN插针)	19芯针座 

# 12针/17针/19针M23现场可接线连接器



现场可接线连接器	型号	订货号	特性描述	针脚编号分布
M23 直角型 压接连接  	GNLK1228-0/M22/C	10095057	铜锌合金 M22电缆出线口 可连接的电缆外径范围: 6-10mm 焊接连接 85°C, 300 V, 8 A 压接连接: (型号自带12PIN插针)	12芯孔座
	GNLZ1228-0/M22/C	10095056	铜锌合金 M22电缆出线口 可连接的电缆外径范围: 6-10mm 焊接连接 85°C, 300 V, 8 A 压接连接: (型号自带12PIN插针)	12芯针座
	GNLK1728-0/M22/C	10095058	铜锌合金 M22电缆出线口 可连接的电缆外径范围: 6-10mm 焊接连接 85°C, 150 V, 8 A 压接连接: (型号自带17PIN插针)	17芯孔座
	GNLZ1728-0/M22/C	10095086	铜锌合金 M22电缆出线口 可连接的电缆外径范围: 6-10mm 焊接连接 85°C, 150 V, 8 A 压接连接: (型号自带17PIN插针)	17芯针座
	GNLK1928-0/M22/C	10095059	铜锌合金 M22电缆出线口 可连接的电缆外径范围: 6-10mm 焊接连接 85°C, 150 V, 8 A	19芯孔座
	GNLZ1928-0/M22/C	10095087	铜锌合金 M22电缆出线口 可连接的电缆外径范围: 6-10mm 焊接连接 85°C, 150 V, 8 A	19芯针座



法兰连接器	型号	订货号	特性描述	针脚编号分布
<p>M23 后端锁紧 出线 孔座</p>	FGWK12-112-0.5/M20 FGWK12-112-1.0/M20	10044990 10044991	线规: 11x0.75mm <sup>2</sup> 材质: PVC 电流: 6A 电压: 300V	<p>孔座</p> <ol style="list-style-type: none"> <li>1. WH</li> <li>2. BN/BU</li> <li>3. YE</li> <li>4. GY</li> <li>5. PK</li> <li>6. RD</li> <li>7. BK</li> <li>8. VT</li> <li>9. BU</li> <li>10. BU</li> <li>11. BN</li> <li>12. GN/YE</li> </ol>
	FGWK12-122-0.5/M20 FGWK12-122-1.0/M20	10045000 10045145	线规: 12x0.75mm <sup>2</sup> 材质: PVC 电流: 6A 电压: 300V	<p>孔座</p> <ol style="list-style-type: none"> <li>1. BN</li> <li>2. BU</li> <li>3. WH</li> <li>4. BN/RD</li> <li>5. OG</li> <li>6. YE</li> <li>7. GY</li> <li>8. PK</li> <li>9. RD</li> <li>10. BN/WH</li> <li>11. BU/WH</li> <li>12. GN/WH</li> </ol>
	FGWK17-172-0.5/M20 FGWK17-172-1.0/M20	10044980 10044981	电源: 3x0.75mm <sup>2</sup> 信号: 14X0.34mm <sup>2</sup> 材质: PVC 电源: 9A 信号: 2A 电压: 150V	<p>孔座</p> <ol style="list-style-type: none"> <li>1. BU</li> <li>2. RD</li> <li>3. BN</li> <li>4. GY</li> <li>5. BN/RD</li> <li>6. RD/BU</li> <li>7. BN/BU</li> <li>8. GY/PK</li> <li>9. WH/GN</li> <li>10. WH/YE</li> <li>11. WH/GY</li> <li>12. BK</li> <li>13. YE/BN</li> <li>14. BN/GN</li> <li>15. WH</li> <li>16. YE</li> <li>17. PK</li> </ol>
	FGWK19-112-0.5/M20 FGWK19-112-1.0/M20	10044970 10044971	电源: 3x0.75mm <sup>2</sup> 信号: 8X0.34mm <sup>2</sup> 材质: PVC 电源: 9A 信号: 2A 电压: 150V	<p>孔座</p> <ol style="list-style-type: none"> <li>1. N/C</li> <li>2. N/C</li> <li>3. GY</li> <li>4. RD/BU</li> <li>5. BN/BU</li> <li>6. BU</li> <li>7. GY/PK</li> <li>8. WH/GN</li> <li>9. N/C</li> <li>10. N/C</li> <li>11. N/C</li> <li>12. BN/RD</li> <li>13. N/C</li> <li>14. BN/GN</li> <li>15. WH</li> <li>16. YE</li> <li>17. N/C</li> <li>18. N/C</li> <li>19. BN</li> </ol>
	FGWK19-152-0.5/M20 FGWK19-152-1.0/M20	10044960 10044961	电源: 3x0.75mm <sup>2</sup> 信号: 12X0.34mm <sup>2</sup> 材质: PVC 电源: 9A 信号: 2A 电压: 150V	<p>孔座</p> <ol style="list-style-type: none"> <li>1. N/C</li> <li>2. RD</li> <li>3. GY</li> <li>4. RD/BU</li> <li>5. BN/BU</li> <li>6. BU</li> <li>7. GY/PK</li> <li>8. WH/GN</li> <li>9. WH/YE</li> <li>10. N/C</li> <li>11. N/C</li> <li>12. BN/RD</li> <li>13. YE/BN</li> <li>14. BN/GN</li> <li>15. WH</li> <li>16. YE</li> <li>17. PK</li> <li>18. N/C</li> <li>19. BN</li> </ol>
	FGWK19-192-0.5/M20 FGWK19-192-1.0/M20	10045010 10044021	电源: 3x0.75mm <sup>2</sup> 信号: 16X0.34mm <sup>2</sup> 材质: PVC 电源: 9A 信号: 2A 电压: 150V	<p>孔座</p> <ol style="list-style-type: none"> <li>1. VT</li> <li>2. RD</li> <li>3. GY</li> <li>4. RD/BU</li> <li>5. BN/BU</li> <li>6. BU</li> <li>7. GY/PK</li> <li>8. WH/GN</li> <li>9. WH/YE</li> <li>10. WH/GY</li> <li>11. BK</li> <li>12. BN/RD</li> <li>13. YE/BN</li> <li>14. BN/GN</li> <li>15. WH</li> <li>16. YE</li> <li>17. PK</li> <li>18. GY/BN</li> <li>19. BN</li> </ol>

# M23法兰连接器



法兰连接器	型号	订货号	特性描述	针脚编号分布
<p>M23 后端锁紧 出线 针座</p> <p>开孔尺寸</p>	FGWZ12-112-0.5/M20 FGWZ12-112-1.0/M20	10044950 10044951	线规: 11x0.75mm <sup>2</sup> 材质: PVC 电流: 6A 电压: 300V	<p>针座</p> <ol style="list-style-type: none"> <li>1. WH</li> <li>2. BN/BU</li> <li>3. YE</li> <li>4. GY</li> <li>5. PK</li> <li>6. RD</li> <li>7. BK</li> <li>8. VT</li> <li>9. BU</li> <li>10. BU</li> <li>11. BN</li> <li>12. BN/RD</li> </ol>
	FGWZ12-122-0.5/M20 FGWZ12-122-1.0/M20	10045120 10045119	线规: 12x0.75mm <sup>2</sup> 材质: PVC 电流: 6A 电压: 300V	<p>针座</p> <ol style="list-style-type: none"> <li>1. BN</li> <li>2. BU</li> <li>3. WH</li> <li>4. BN/RD</li> <li>5. OG</li> <li>6. YE</li> <li>7. GY</li> <li>8. PK</li> <li>9. RD</li> <li>10. BN/WH</li> <li>11. BU/WH</li> <li>12. GN/WH</li> </ol>
	FGWZ17-172-0.5/M20 FGWZ17-172-1.0/M20	10044940 10044941	电源: 3x0.75mm <sup>2</sup> 信号: 14X0.34mm <sup>2</sup> 材质: PVC 电源: 9A 信号: 2A 电压: 150V	<p>针座</p> <ol style="list-style-type: none"> <li>1. BU</li> <li>2. RD</li> <li>3. BN</li> <li>4. GY</li> <li>5. BN/RD</li> <li>6. RD/BU</li> <li>7. BN/BU</li> <li>8. GY/PK</li> <li>9. WH/GN</li> <li>10. WH/YE</li> <li>11. WH/GY</li> <li>12. BK</li> <li>13. YE/BN</li> <li>14. BN/GN</li> <li>15. WH</li> <li>16. YE</li> <li>17. PK</li> </ol>
	FGWZ19-112-0.5/M20 FGWZ19-112-1.0/M20	10044930 10044931	电源: 3x0.75mm <sup>2</sup> 信号: 8X0.34mm <sup>2</sup> 材质: PVC 电源: 9A 信号: 2A 电压: 150V	<p>针座</p> <ol style="list-style-type: none"> <li>1. N/C</li> <li>2. N/C</li> <li>3. GY</li> <li>4. RD/BU</li> <li>5. BN/BU</li> <li>6. BU</li> <li>7. GY/PK</li> <li>8. WH/GN</li> <li>9. N/C</li> <li>10. N/C</li> <li>11. N/C</li> <li>12. BN/RD</li> <li>13. N/C</li> <li>14. BN/GN</li> <li>15. WH</li> <li>16. YE</li> <li>17. N/C</li> <li>18. N/C</li> <li>19. BN</li> </ol>
	FGWZ19-152-0.5/M20 FGWZ19-152-1.0/M20	10044920 10044921	电源: 3x0.75mm <sup>2</sup> 信号: 12X0.34mm <sup>2</sup> 材质: PVC 电源: 9A 信号: 2A 电压: 150V	<p>针座</p> <ol style="list-style-type: none"> <li>1. N/C</li> <li>2. RD</li> <li>3. GY</li> <li>4. RD/BU</li> <li>5. BN/BU</li> <li>6. BU</li> <li>7. GY/PK</li> <li>8. WH/GN</li> <li>9. WH/YE</li> <li>10. N/C</li> <li>11. N/C</li> <li>12. BN/RD</li> <li>13. YE/BN</li> <li>14. BN/GN</li> <li>15. WH</li> <li>16. YE</li> <li>17. PK</li> <li>18. N/C</li> <li>19. BN</li> </ol>
	FGWZ19-192-0.5/M20 FGWZ19-192-1.0/M20	10045130 10045133	电源: 3x0.75mm <sup>2</sup> 信号: 16X0.34mm <sup>2</sup> 材质: PVC 电源: 9A 信号: 2A 电压: 150V	<p>针座</p> <ol style="list-style-type: none"> <li>1. VT</li> <li>2. RD</li> <li>3. GY</li> <li>4. RD/BU</li> <li>5. BN/BU</li> <li>6. BU</li> <li>7. GY/PK</li> <li>8. WH/GN</li> <li>9. WH/YE</li> <li>10. WH/GY</li> <li>11. BK</li> <li>12. BN/RD</li> <li>13. YE/BN</li> <li>14. BN/GN</li> <li>15. WH</li> <li>16. YE</li> <li>17. PK</li> <li>18. GY/BN</li> <li>19. BN</li> </ol>

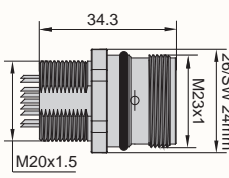
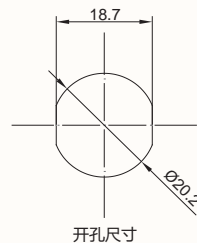
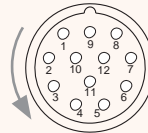
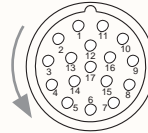
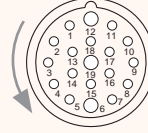
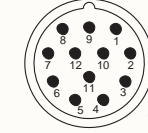
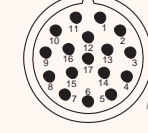
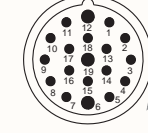

法兰连接器	型号	订货号	特性描述	针脚编号分布
M23 后端锁紧 焊接连接     开孔尺寸	FGWK122-L/M20	10045002	线规: 0.75mm <sup>2</sup> 电流: 6A 电压: 150V 连接: 焊接	孔座 
	FGWK172-L/M20	10045003	线规: 0.75mm <sup>2</sup> 电流: 6A 电压: 150V 连接: 焊接	孔座 
	FGWK192-L/M20	10045141	电源: 0.75mm <sup>2</sup> 信号: 0.34mm <sup>2</sup> 电源: 9A 信号: 2A 电压: 150V 连接: 焊接	孔座 
	FGWZ122-L/M20	10045122	线规: 0.75mm <sup>2</sup> 电源: 9A 信号: 2A 电压: 150V 连接: 焊接	针座 
	FGWZ172-L/M20	10045004	线规: 0.75mm <sup>2</sup> 电源: 9A 信号: 2A 电压: 150V 连接: 焊接	针座 
	FGWZ192-L/M20	10045132	电源: 0.75mm <sup>2</sup> 信号: 0.34mm <sup>2</sup> 电源: 9A 信号: 2A 电压: 150V 连接: 焊接	针座 

# M23法兰连接器(反向)



法兰连接器	型号	订货号	特性描述	针脚编号分布
M23 后端锁紧,出线	FGWK12-12R2-0.5/M20 FGWK12-12R2-1.0/M20	10044510 10044511	线规: 12x0.75mm <sup>2</sup> 材质: PVC 电流: 6A 电压: 300V	<p>孔座</p> <ul style="list-style-type: none"> <li>1. BN</li> <li>2. BU</li> <li>3. WH</li> <li>4. BN/RD</li> <li>5. OG</li> <li>6. YE</li> <li>7. GY</li> <li>8. PK</li> <li>11. BU/WH</li> <li>9. RD</li> <li>12. GN/WH</li> <li>10. BN/WH</li> </ul>
	FGWK17-17R2-0.5/M20 FGWK17-17R2-1.0/M20	10044520 10044521	电源: 3x0.75mm <sup>2</sup> 信号: 14X0.34mm <sup>2</sup> 材质: PVC 电源: 9A 信号: 2A 电压: 150V	<p>孔座</p> <ul style="list-style-type: none"> <li>1. BU</li> <li>2. RD</li> <li>3. BN</li> <li>4. GY</li> <li>5. BN/RD</li> <li>6. RD/BU</li> <li>7. BN/BU</li> <li>13. YE/BN</li> <li>8. GY/PK</li> <li>14. BN/GN</li> <li>9. WH/GN</li> <li>15. WH</li> <li>10. WH/YE</li> <li>16. YE</li> <li>11. WH/GY</li> <li>17. PK</li> <li>12. BK</li> </ul>
	FGWZ12-12R2-0.5/M20 FGWZ12-12R2-1.0/M20	10044570 10044571	线规: 12x0.75mm <sup>2</sup> 材质: PVC 电流: 6A 电压: 300V	<p>针座</p> <ul style="list-style-type: none"> <li>1. BN</li> <li>2. BU</li> <li>3. WH</li> <li>4. BN/RD</li> <li>5. OG</li> <li>6. YE</li> <li>7. GY</li> <li>8. PK</li> <li>11. BU/WH</li> <li>9. RD</li> <li>12. GN/WH</li> <li>10. BN/WH</li> </ul>
	FGWZ17-17R2-0.5/M20 FGWZ17-17R2-1.0/M20	10044580 10044581	电源: 3x0.75mm <sup>2</sup> 信号: 14X0.34mm <sup>2</sup> 材质: PVC 电源: 9A 信号: 2A 电压: 150V	<p>针座</p> <ul style="list-style-type: none"> <li>1. BU</li> <li>2. RD</li> <li>3. BN</li> <li>4. GY</li> <li>5. BN/RD</li> <li>6. RD/BU</li> <li>7. BN/BU</li> <li>13. YE/BN</li> <li>8. GY/PK</li> <li>14. BN/GN</li> <li>9. WH/GN</li> <li>15. WH</li> <li>10. WH/YE</li> <li>16. YE</li> <li>11. WH/GY</li> <li>17. PK</li> <li>12. BK</li> </ul>

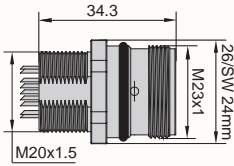
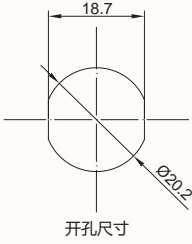
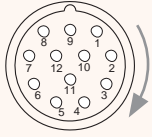
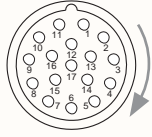
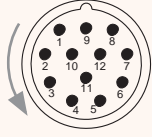
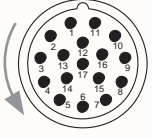

法兰连接器	型号	订货号	特性描述	针脚编号分布
M23 后端锁紧 焊接连接    	FGWK12R2-L/M20	10044710	线规: 0.75mm <sup>2</sup> 电流: 6A 电压: 300V 连接: 焊接	孔座 
	FGWK17R2-L/M20	10044711	线规: 0.75mm <sup>2</sup> 电流: 6A 电压: 150V 连接: 焊接	孔座 
	FGWZ12R2-L/M20	10044713	线规: 0.75mm <sup>2</sup> 电源: 9A 信号: 2A 电压: 300V 连接: 焊接	针座 
	FGWZ17R2-L/M20	10044714	线规: 0.75mm <sup>2</sup> 电源: 9A 信号: 2A 电压: 150V 连接: 焊接	针座 

# M23法兰连接器



法兰连接器	型号	订货号	特性描述	针脚编号分布
<p>M23 方型螺钉连接,出线 孔座</p> <p>方盘外形尺寸</p> <p>开孔尺寸</p>	FGWK12-11-0.5/RS19.8 FGWK12-11-1.0/RS19.8	10044220 10044221	线规: 11x0.75mm <sup>2</sup> 材质: PVC 电流: 6A 电压: 300V	孔座 <ol style="list-style-type: none"> <li>WH</li> <li>BN/BU</li> <li>YE</li> <li>GY</li> <li>PK</li> <li>RD</li> <li>BK</li> <li>VT</li> <li>BU</li> <li>BN</li> <li>BN/RD</li> <li>BU</li> </ol>
	FGWK12-12-0.5/RS19.8 FGWK12-12-1.0/RS19.8	10044230 10044231	线规: 12x0.75mm <sup>2</sup> 材质: PVC 电流: 6A 电压: 300V	孔座 <ol style="list-style-type: none"> <li>BN</li> <li>BU</li> <li>WH</li> <li>BN/RD</li> <li>OG</li> <li>YE</li> <li>GY</li> <li>PK</li> <li>RD</li> <li>BU/WH</li> <li>GN/WH</li> <li>BN/WH</li> </ol>
	FGWK17-17-0.5/RS19.8 FGWK17-17-1.0/RS19.8	10044240 10044241	电源: 3x0.75mm <sup>2</sup> 信号: 14X0.34mm <sup>2</sup> 材质: PVC 电源: 9A 信号: 2A 电压: 150V	孔座 <ol style="list-style-type: none"> <li>BU</li> <li>RD</li> <li>BN</li> <li>GY</li> <li>BN/RD</li> <li>RD/BU</li> <li>BN/BU</li> <li>GY/PK</li> <li>YE/BN</li> <li>BN/GN</li> <li>WH/GN</li> <li>WH</li> <li>WH/YE</li> <li>YE</li> <li>WH/GY</li> <li>PK</li> <li>BK</li> </ol>
	FGWK19-11-0.5/RS19.8 FGWK19-11-1.0/RS19.8	10044250 10044251	电源: 3x0.75mm <sup>2</sup> 信号: 8X0.34mm <sup>2</sup> 材质: PVC 电源: 9A 信号: 2A 电压: 150V	孔座 <ol style="list-style-type: none"> <li>N/C</li> <li>N/C</li> <li>GY</li> <li>RD/BU</li> <li>BN/BU</li> <li>BU</li> <li>GY/PK</li> <li>WH/GN</li> <li>YE/BN</li> <li>BN/GN</li> <li>WH</li> <li>WH/GN</li> <li>YE</li> <li>N/C</li> <li>N/C</li> <li>N/C</li> <li>N/C</li> <li>BN</li> <li>BN/RD</li> </ol>
	FGWK19-15-0.5/RS19.8 FGWK19-15-1.0/RS19.8	10044260 10044261	电源: 3x0.75mm <sup>2</sup> 信号: 12X0.34mm <sup>2</sup> 材质: PVC 电源: 9A 信号: 2A 电压: 150V	孔座 <ol style="list-style-type: none"> <li>N/C</li> <li>RD</li> <li>GY</li> <li>RD/BU</li> <li>BN/BU</li> <li>BU</li> <li>GY/PK</li> <li>WH/GN</li> <li>YE/BN</li> <li>BN/GN</li> <li>WH</li> <li>WH/GN</li> <li>YE</li> <li>WH/YE</li> <li>PK</li> <li>N/C</li> <li>N/C</li> <li>BN</li> <li>BN/RD</li> </ol>
	FGWK19-19-0.5/RS19.8 FGWK19-19-1.0/RS19.8	10044270 10044271	电源: 3x0.75mm <sup>2</sup> 信号: 16X0.34mm <sup>2</sup> 材质: PVC 电源: 9A 信号: 2A 电压: 150V	孔座 <ol style="list-style-type: none"> <li>VT</li> <li>RD</li> <li>GY</li> <li>RD/BU</li> <li>BN/BU</li> <li>BU</li> <li>GY/PK</li> <li>WH/GN</li> <li>YE/BN</li> <li>BN/GN</li> <li>WH</li> <li>WH/GN</li> <li>YE</li> <li>WH/YE</li> <li>PK</li> <li>WH/GY</li> <li>GY/BN</li> <li>BK</li> <li>BN</li> <li>BN/RD</li> </ol>



法兰连接器	型号	订货号	特性描述	针脚编号分布
<p>方盘外形尺寸</p> <p>开孔尺寸</p>	M23 方型螺钉连接,出线 针座			
	FGWZ12-11-0.5/RS19.8 FGWZ12-11-1.0/RS19.8	10044280 10044281	线规: 11x0.75mm <sup>2</sup> 材质: PVC 电流: 6A 电压: 300V	<p>针座</p> <ol style="list-style-type: none"> <li>1. WH</li> <li>2. BN/BU</li> <li>3. YE</li> <li>4. GY</li> <li>5. PK</li> <li>6. RD</li> <li>7. BK</li> <li>8. VT</li> <li>9. BU</li> <li>10. BU</li> <li>11. BN</li> <li>12. BN/RD</li> </ol>
	FGWZ12-12-0.5/RS19.8 FGWZ12-12-1.0/RS19.8	10044290 10044291	线规: 12x0.75mm <sup>2</sup> 材质: PVC 电流: 6A 电压: 300V	<p>针座</p> <ol style="list-style-type: none"> <li>1. BN</li> <li>2. BU</li> <li>3. WH</li> <li>4. BN/RD</li> <li>5. OG</li> <li>6. YE</li> <li>7. GY</li> <li>8. PK</li> <li>9. RD</li> <li>10. BN/WH</li> <li>11. BU/WH</li> <li>12. GN/WH</li> </ol>
	FGWZ17-17-0.5/RS19.8 FGWZ17-17-1.0/RS19.8	10044300 10044301	电源: 3x0.75mm <sup>2</sup> 信号: 14X0.34mm <sup>2</sup> 材质: PVC 电源: 9A 信号: 2A 电压: 150V	<p>针座</p> <ol style="list-style-type: none"> <li>1. BU</li> <li>2. RD</li> <li>3. BN</li> <li>4. GY</li> <li>5. BN/RD</li> <li>6. RD/BU</li> <li>7. BN/BU</li> <li>8. GY/PK</li> <li>9. WH/GN</li> <li>10. WH/YE</li> <li>11. WH/GY</li> <li>12. BK</li> <li>13. YE/BN</li> <li>14. BN/GN</li> <li>15. WH</li> <li>16. YE</li> <li>17. PK</li> </ol>
	FGWZ19-11-0.5/RS19.8 FGWZ19-11-1.0/RS19.8	10044310 10044311	电源: 3x0.75mm <sup>2</sup> 信号: 8X0.34mm <sup>2</sup> 材质: PVC 电源: 9A 信号: 2A 电压: 150V	<p>针座</p> <ol style="list-style-type: none"> <li>1. N/C</li> <li>2. N/C</li> <li>3. GY</li> <li>4. RD/BU</li> <li>5. BN/BU</li> <li>6. BU</li> <li>7. GY/PK</li> <li>8. WH/GN</li> <li>9. N/C</li> <li>10. N/C</li> <li>11. N/C</li> <li>12. N/C</li> <li>13. N/C</li> <li>14. BN/GN</li> <li>15. WH</li> <li>16. YE</li> <li>17. N/C</li> <li>18. N/C</li> <li>19. BN</li> </ol>
	FGWZ19-15-0.5/RS19.8 FGWZ19-15-1.0/RS19.8	10044450 10044451	电源: 3x0.75mm <sup>2</sup> 信号: 12X0.34mm <sup>2</sup> 材质: PVC 电源: 9A 信号: 2A 电压: 150V	<p>针座</p> <ol style="list-style-type: none"> <li>1. N/C</li> <li>2. RD</li> <li>3. GY</li> <li>4. RD/BU</li> <li>5. BN/BU</li> <li>6. BU</li> <li>7. GY/PK</li> <li>8. WH/GN</li> <li>9. WH/YE</li> <li>10. N/C</li> <li>11. N/C</li> <li>12. N/C</li> <li>13. YE/BN</li> <li>14. BN/GN</li> <li>15. WH</li> <li>16. YE</li> <li>17. PK</li> <li>18. N/C</li> <li>19. BN</li> </ol>
	FGWZ19-19-0.5/RS19.8 FGWZ19-19-1.0/RS19.8	10044320 10044321	电源: 3x0.75mm <sup>2</sup> 信号: 16X0.34mm <sup>2</sup> 材质: PVC 电源: 9A 信号: 2A 电压: 150V	<p>针座</p> <ol style="list-style-type: none"> <li>1. VT</li> <li>2. RD</li> <li>3. GY</li> <li>4. RD/BU</li> <li>5. BN/BU</li> <li>6. BU</li> <li>7. GY/PK</li> <li>8. WH/GN</li> <li>9. WH/YE</li> <li>10. WH/GY</li> <li>11. BK</li> <li>12. BN/RD</li> <li>13. YE/BN</li> <li>14. BN/GN</li> <li>15. WH</li> <li>16. PK</li> <li>17. PK</li> <li>18. GY/BN</li> <li>19. BN</li> </ol>

# M23法兰连接器(反向)



法兰连接器	型号	订货号	特性描述	针脚编号分布
<p>M23 方型螺钉连接 反向出线</p> <p>方盘外形尺寸</p> <p>开孔尺寸</p>	FGWZ12-12R-0.5/RS19.8	10044400	线规: 12x0.75mm <sup>2</sup> 材质: PVC 电流: 6A 电压: 300V	<p>针座</p> <ul style="list-style-type: none"> <li>1. BN</li> <li>2. BU</li> <li>3. WH</li> <li>4. BN/RD</li> <li>5. OG</li> <li>6. YE</li> <li>7. GY</li> <li>8. PK</li> <li>9. RD</li> <li>10. GN/WH</li> <li>11. BU/WH</li> <li>12. GN/WH</li> </ul>
	FGWZ12-12R-1.0/RS19.8	10044401		
	FGWZ17-17R-0.5/RS19.8	10044410	电源: 3x0.75mm <sup>2</sup> 信号: 14X0.34mm <sup>2</sup> 材质: PVC 电源: 9A 信号: 2A 电压: 150V	<p>针座</p> <ul style="list-style-type: none"> <li>1. BU</li> <li>2. RD</li> <li>3. BN</li> <li>4. GY</li> <li>5. BN/RD</li> <li>6. RD/BU</li> <li>7. BN/BU</li> <li>8. GY/PK</li> <li>9. WH/GN</li> <li>10. WH/YE</li> <li>11. WH/GY</li> <li>12. BK</li> <li>13. YE/BN</li> <li>14. BN/GN</li> <li>15. WH</li> <li>16. YE</li> <li>17. PK</li> </ul>
	FGWZ17-17R-1.0/RS19.8	10044411		
	FGWK12-12R-0.5/RS19.8	10044340	线规: 12x0.75mm <sup>2</sup> 材质: PVC 电流: 6A 电压: 300V	<p>孔座</p> <ul style="list-style-type: none"> <li>1. BN</li> <li>2. BU</li> <li>3. WH</li> <li>4. BN/RD</li> <li>5. OG</li> <li>6. YE</li> <li>7. GY</li> <li>8. PK</li> <li>9. RD</li> <li>10. GN/WH</li> <li>11. BU/WH</li> <li>12. GN/WH</li> </ul>
	FGWK12-12R-1.0/RS19.8	10044341		
	FGWK17-17R-0.5/RS19.8	10044350	电源: 3x0.75mm <sup>2</sup> 信号: 14X0.34mm <sup>2</sup> 材质: PVC 电源: 9A 信号: 2A 电压: 150V	<p>孔座</p> <ul style="list-style-type: none"> <li>1. BU</li> <li>2. RD</li> <li>3. BN</li> <li>4. GY</li> <li>5. BN/RD</li> <li>6. RD/BU</li> <li>7. BN/BU</li> <li>8. GY/PK</li> <li>9. WH/GN</li> <li>10. WH/YE</li> <li>11. WH/GY</li> <li>12. BK</li> <li>13. YE/BN</li> <li>14. BN/GN</li> <li>15. WH</li> <li>16. YE</li> <li>17. PK</li> </ul>
	FGWK17-17R-1.0/RS19.8	10044351		



法兰连接器	型号	订货号	特性描述	针脚编号分布
<p>M23 方型螺钉连接,压接 孔座</p>	<p>FGNK6-C/RS19.8</p> <p>FGNK6-C1/RS19.8</p>	<p>10044275</p> <p>10044276</p>	<p>外壳材质铜锌合金 105°C 电源: 630 V, 28 A</p> <p>压接连接 /C 母针型号GK1-2.5-C.6228 可接线芯范围:1~2.5mm<sup>2</sup> /C1 母针型号GK2.5-4-C1.6228 可接线芯范围:2.5~4mm<sup>2</sup> (型号自带6PIN插针)</p>	<p>孔座</p>
	<p>FGNK8-C/RS19.8</p> <p>FGNK8-C1/RS19.8</p>	<p>10044995</p> <p>10044277</p>	<p>外壳材质铜锌合金 105°C 电源: 630 V(粗);250V(细) 30 A(粗);10A(细)</p> <p>压接连接 /C 母针(粗)型号GK1-2.5-C.8228 母针(细)型号GK0.25-1-C.8228 /C1 母针(粗)型号GK2.5-4-C1.8228 母针(细)型号GK0.75-1.5-C1.8228 (型号自带8PIN插针)</p>	<p>孔座</p>
<p>M23 方型螺钉连接 压接 针座</p>	<p>FGWZ6-C/RS19.8</p> <p>FGWZ6-C1/RS19.8</p>	<p>10044266</p> <p>10044267</p>	<p>外壳材质铜锌合金 105°C 电源: 630 V, 28 A</p> <p>压接连接 /C 公针型号GZ1-2.5-C.6228 可接线芯范围:1~2.5mm<sup>2</sup> /C1 公针型号GZ2.5-4-C1.6228 可接线芯范围:2.5~4mm<sup>2</sup> (型号自带6PIN插针)</p>	<p>针座</p>
	<p>FGWZ8-C/RS19.8</p> <p>FGWZ8-C1/RS19.8</p>	<p>10052306</p> <p>10044268</p>	<p>外壳材质铜锌合金 105°C 电源: 630 V(粗);250V(细) 30 A(粗);10A(细)</p> <p>压接连接 /C 公针(粗)型号GZ1-2.5-C.8228 公针(细)型号GZ0.25-1-C.8228 /C1 公针(粗)型号GZ2.5-4-C1.8228 公针(细)型号GZ0.75-1.5-C1.8228 (型号自带8PIN插针)</p>	<p>针座</p>

# 6针/8针M23法兰连接器



现场可接线连接器	型号	订货号	特性描述	针脚编号分布
M23 方型螺钉连接L直角型 压接 	FGWLZ6-C/RS19.8	10049645	外壳材质铜锌合金 105°C 电源: 630 V, 28 A 压接连接 /C 公针型号GZ1-2.5-C.6228 可接线芯范围:1~2.5mm <sup>2</sup> /C1 公针型号GZ2.5-4-C1.6228 可接线芯范围:2.5~4mm <sup>2</sup> (型号自带6PIN插针)	6芯针座 
	FGWLZ6-C1/RS19.8	10049644		外壳材质铜锌合金 105°C 电源: 630 V(粗);250V(细) 30 A(粗);10A(细) 压接连接 /C 公针(粗)型号GZ1-2.5-C.8228 公针(细)型号GZ0.25-1-C.8228 /C1 公针(粗)型号GZ2.5-4-C1.8228 公针(细)型号GZ0.75-1.5-C1.8228 (型号自带8PIN插针)
	FGWLZ8-C/RS19.8	10049646		
	FGWLZ8-C1/RS19.8	10049500		



现场可接线连接器	型号	订货号	特性描述	针脚编号分布
<p>M23 方型螺钉连接L直角型 压接/焊接</p>	FGWLZ12-C/RS19.8	10049792	外壳材质铜锌合金 电源: 300 V,6 A 压接连接 /C 公针型号GZ0.25-1-C.1228 可接线芯范围 0.25~1mm <sup>2</sup> (型号自带12PIN插针)	12芯针座 
	FGWLZ12-L/RS19.8	10093000	外壳材质铜锌合金 焊接连接 电源: 300 V,6 A 可接线芯范围: 0.25~0.75mm <sup>2</sup>	
	FGWLZ17-C/RS19.8	10093001	外壳材质铜锌合金 压接连接 电源: 150 V,6 A 压接连接 /C 公针型号GZ0.25-1-C.1228 可接线芯范围 0.25~1mm <sup>2</sup> (型号自带17PIN插针)	17芯针座 
	FGWLZ17-L/RS19.8	10093002	外壳材质铜锌合金 焊接连接 电源: 150 V,6 A 可接线芯范围: 0.25~0.75mm <sup>2</sup>	
	FGWLZ19-C/RS19.8	10093020	外壳材质铜锌合金 电源: 150 V, 9A(粗),2A(细) 压接连接: /C 公针(粗)型号GZ0.25-1-C.1928 公针(细)型号GZ0.25-1-C.1228 可接线芯范围 0.25~1mm <sup>2</sup> (型号自带19PIN插针)	19芯针座 
	FGWLZ19-L/RS19.8	10093021	外壳材质铜锌合金 焊接连接 电源: 150 V,9A(粗),2A(细) 可接线芯范围: 0.25~0.75mm <sup>2</sup>	

GNK6228-0/M24/C 安装说明

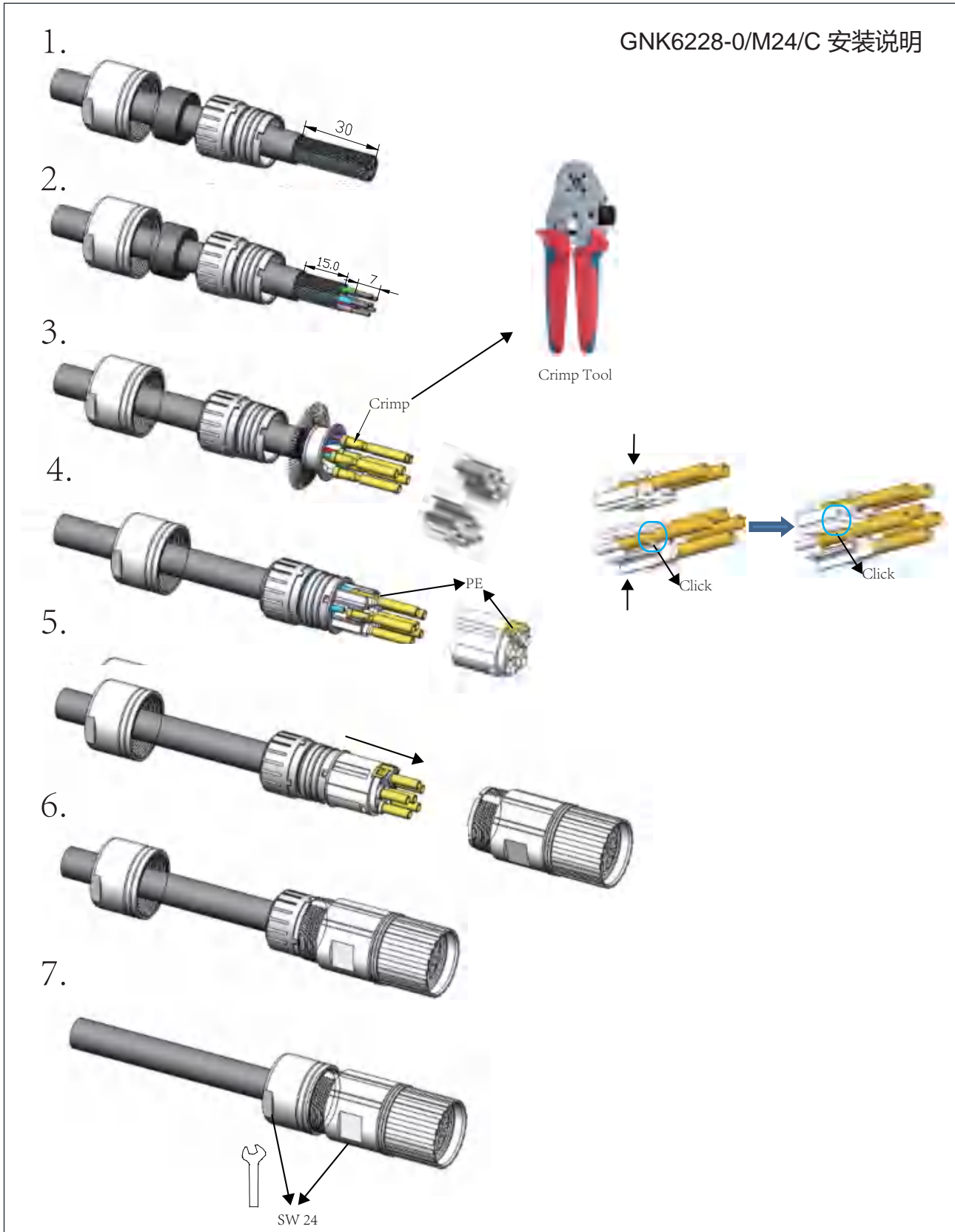

FGWZ6-C/RS19.8 安装说明

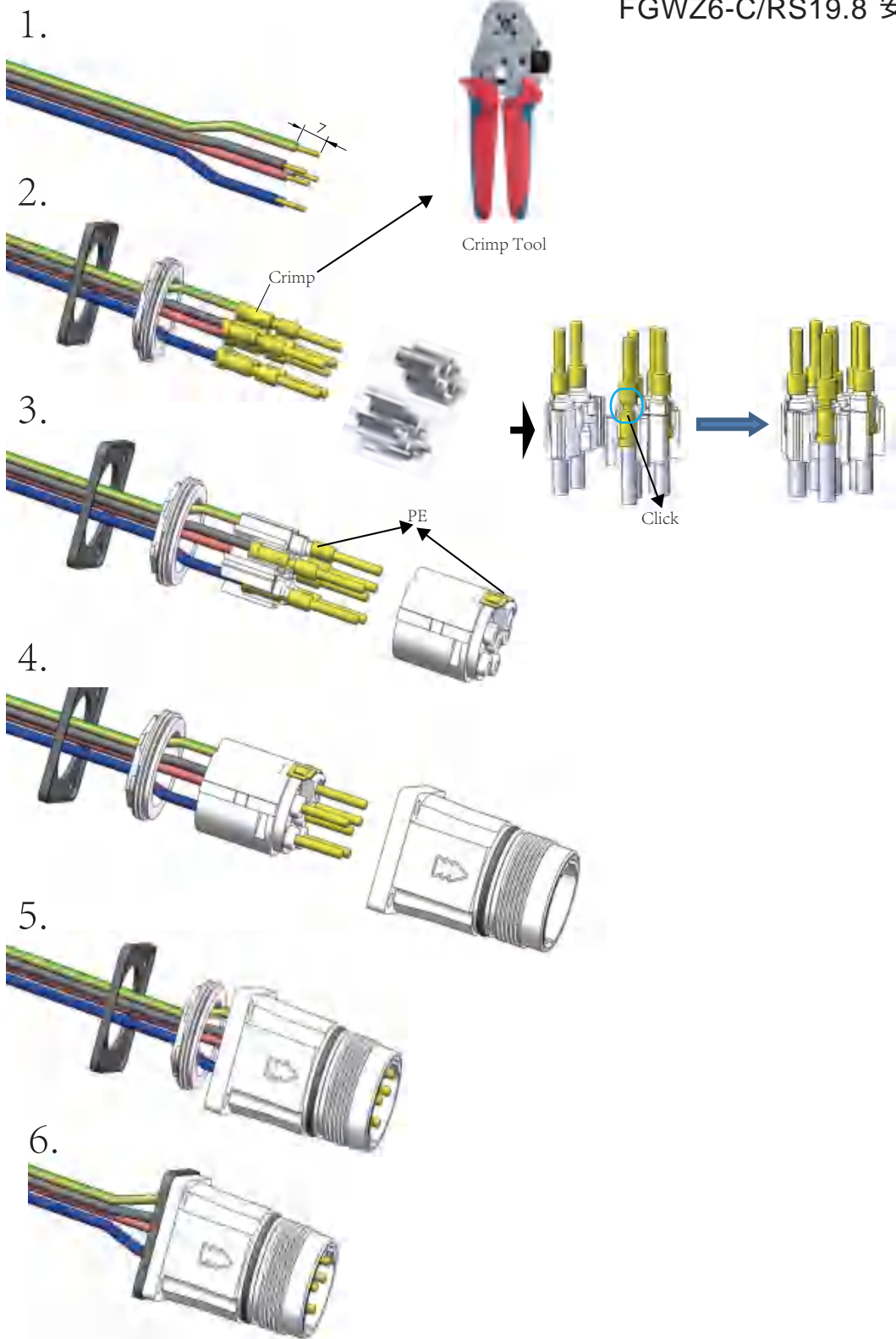





## ■ M40 工业连接器

# M40预铸式连接器型号命名规则

## 预铸式连接器命名规则

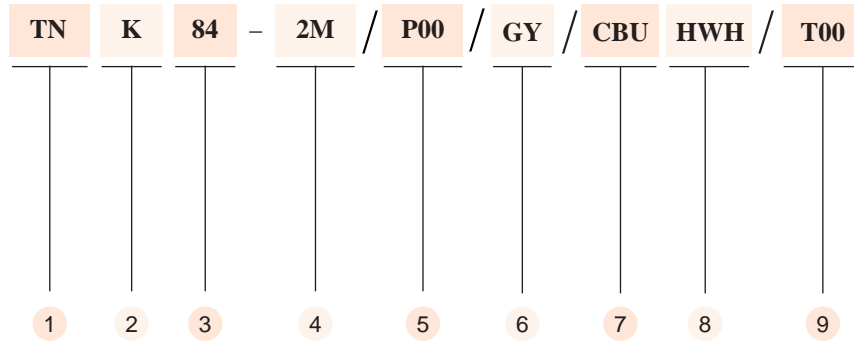

- |   |  |   |   |
|---|--|---|---|
| 1 | TN M40x1.5连接器_内螺纹<br>TW M40x1.5连接器_外螺纹                           | 6 | 电缆颜色<br>Blank 标准色 (P00 橙,P10 橙)<br>GY 灰色 (定制化)<br>YE 黄色 (定制化) |
| 2 | K 孔座<br>Z 针座   | 7 | 针托颜色<br>Blank 标准色 黑色<br>CBU 蓝色针托 (定制化)                        |
| 3 | 针脚数<br>触点分配<br>84: 8芯, 4粗针+4细针<br>64: 6芯, 4粗针+2细针<br>44: 4芯, 4粗针 | 8 | 预铸接头颜色<br>Blank 标准色黑色<br>HWH 白色预铸接头 (定制化)                     |
| 4 | 线缆长度[m]  | 9 | 特殊规格定制  |
| 5 | 线缆材质代码   |   |   |

## 双端预铸连接器型号说明



TNK84 TWZ84-2M/P00

## 现场可接线连接器命名规则

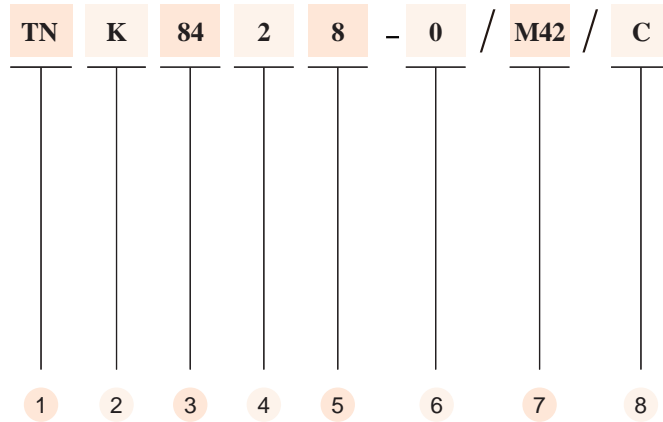

1 TN M40x1.5连接器\_内螺纹  
TW M40x1.5连接器\_外螺纹

2 K 孔座  
Z 针座

3 针脚数  
触点分配  
84: 8芯, 4粗针+4细针  
64: 6芯, 4粗针+2细针  
44: 4芯, 4粗针

4 触点材质  
1 铜合金镀银  
2 铜合金镀金

5 外壳材质  
8 全金属外壳

6 后端连接方式  
0: 单输出口  
1: 双输出口

7 电缆接口  
M42 M42

8 可接线芯范围:  
C: 粗针4-6mm<sup>2</sup>, 细针0.5-4mm<sup>2</sup>  
C1: 粗针1.5-4mm<sup>2</sup>, 细针0.5-4mm<sup>2</sup>  
C2: 粗针6-10mm<sup>2</sup>, 细针0.5-4mm<sup>2</sup>  
C3: 粗针10-16mm<sup>2</sup>, 细针0.5-4mm<sup>2</sup>

## 4针/6针M40预铸式连接器

- 预铸接头:TPU材质,黑色
- 锁紧螺母:黄铜镀镍
- 针托: PA 材质, 黑色
- 触点:黄铜镀金
- 密封圈:FPM/FKM
- 防护等级:IP67
- 电流等级:55A(粗针), 10A(细针)
- 电压等级:630V
- 绝缘电阻: $\geq 10^9 \Omega$
- 接触电阻: $\leq 5m\Omega$
- 污染等级:3
- 使用环境温度: $-40 \dots +80^\circ\text{C}$
- 可插拔寿命:最小100次
- 电缆最大外径: 28mm



预铸式连接器	型号	订货号	电缆	针脚编号分布
直线孔座TNK..** 	TNK44-2M/P00 TNK44-5M/P00 TNK44-10M/P00	10095060 10095061 10095062	橙色PVC 屏蔽电缆 4G8AWG (4G10mm <sup>2</sup> )	孔座 
直线针座TWZ..** 	TWZ44-2M/P00 TWZ44-5M/P00 TWZ44-10M/P00	10095063 10095064 10095065	橙色PVC 屏蔽电缆 4G8AWG (4G10mm <sup>2</sup> )	针座 
直线孔座GNK..** 	TNK64-2M/P00 TNK64-5M/P00 TNK64-10M/P00	10095066 10095067 10095068	橙色PVC 屏蔽电缆 4G10AW- G+2x16AWG (4G10+ 2x1.5mm <sup>2</sup> )	孔座 
直线针座GNZ..** 	TWZ64-2M/P00 TWZ64-5M/P00 TWZ64-10M/P00	10095069 10095070 10095071	橙色PVC 屏蔽电缆 4G10AW- G+2x16AWG (4G10+ 2x1.5mm <sup>2</sup> )	针座 

\* 标准长度为2/5/10米,可订制任意长度

\*\* 标准锁紧螺母材质为黄铜镀镍

## 8针M40预铸式连接器

- 预铸接头:TPU材质,黑色
- 锁紧螺母:黄铜镀镍
- 针托: PA 材质, 黑色
- 触点:黄铜镀金
- 密封圈:FPM/FKM
- 防护等级:IP67
- 电流等级:55A(粗针), 10A(细针)
- 电压等级:630V
- 绝缘电阻: $\geq 10^9 \Omega$
- 接触电阻: $\leq 5m\Omega$
- 污染等级:3
- 使用环境温度: $-40 \dots +80^\circ\text{C}$
- 可插拔寿命:最小100次
- 电缆最大外径: 28mm



预铸式连接器	型号	订货号	电缆	针脚编号分布
直线孔座TNK..** 	TNK84-2M/P00 TNK84-5M/P00 TNK84-10M/P00	10095072 10095073 10095074	橙色PVC 屏蔽电缆 4G8AWG +4x16AWG (4G10 +4x1.5mm <sup>2</sup> )	孔座 
直线针座TWZ..** 	TWZ84-2M/P00 TWZ84-5M/P00 TWZ84-10M/P00	10095075 10095076 10095077	橙色PVC 屏蔽电缆 4G8AWG +4x16AWG (4G10 +4x1.5mm <sup>2</sup> )	针座 

\* 标准长度为2/5/10米,可订制任意长度

\*\* 标准锁紧螺母材质为黄铜镀镍

## 4针/6针M40现场可接线连接器



现场可接线连接器	型号	订货号	特性描述	针脚编号分布
<p>M40 4芯直线孔座</p>	<p>TNK4428-0/M42/C TNK4428-0/M42/C1 TNK4428-0/M42/C2 TNK4428-0/M42/C3</p>	<p>10095084 10095078 10093267 10093268</p>	<p>铜锌合金 M42电缆出线口 可连接的电缆外径范围: 13-18/18~25mm 压接连接 -40°C~125°C 电源: 630V, 55A C: 粗针4-6mm<sup>2</sup>, 细针0.5-4mm<sup>2</sup> C1: 粗针1.5-4mm<sup>2</sup>, 细针0.5-4mm<sup>2</sup> C2: 粗针6-10mm<sup>2</sup>, 细针0.5-4mm<sup>2</sup> C3: 粗针10-16mm<sup>2</sup>, 细针0.5-4mm<sup>2</sup> (型号自带4pin插孔)</p>	<p>孔座</p>
<p>M40 4芯直线针座</p>	<p>TWZ4428-0/M42/C TWZ4428-0/M42/C1 TWZ4428-0/M42/C2 TWZ4428-0/M42/C3</p>	<p>10095085 10095079 10093269 10093270</p>	<p>铜锌合金 M42电缆出线口 可连接的电缆外径范围: 13-18/18~25mm 压接连接 -40°C~125°C 电源: 630V, 55A C: 粗针4-6mm<sup>2</sup>, 细针0.5-4mm<sup>2</sup> C1: 粗针1.5-4mm<sup>2</sup>, 细针0.5-4mm<sup>2</sup> C2: 粗针6-10mm<sup>2</sup>, 细针0.5-4mm<sup>2</sup> C3: 粗针10-16mm<sup>2</sup>, 细针0.5-4mm<sup>2</sup> (型号自带4pin插针)</p>	<p>针座</p>
<p>M40 6芯直线孔座</p>	<p>TNK6428-0/M42/C TNK6428-0/M42/C1 TNK6428-0/M42/C2 TNK6428-0/M42/C3</p>	<p>10093271 10095051 10095019 10095103</p>	<p>铜锌合金 M42电缆出线口 可连接的电缆外径范围: 13-18/18~25mm 压接连接 -40°C~125°C 电源: 630V, 55A 信号: 630V, 10A C: 粗针4-6mm<sup>2</sup>, 细针0.5-4mm<sup>2</sup> C1: 粗针1.5-4mm<sup>2</sup>, 细针0.5-4mm<sup>2</sup> C2: 粗针6-10mm<sup>2</sup>, 细针0.5-4mm<sup>2</sup> C3: 粗针10-16mm<sup>2</sup>, 细针0.5-4mm<sup>2</sup> (型号自带6pin插孔)</p>	<p>孔座</p>
<p>M40 6芯直线针座</p>	<p>TWZ6428-0/M42/C TWZ6428-0/M42/C1 TWZ6428-0/M42/C2 TWZ6428-0/M42/C3</p>	<p>10093272 10095050 10093273 10095104</p>	<p>铜锌合金 M42电缆出线口 可连接的电缆外径范围: 13-18/18~25mm 压接连接 -40°C~125°C 电源: 630V, 55A 信号: 630V, 10A C: 粗针4-6mm<sup>2</sup>, 细针0.5-4mm<sup>2</sup> C1: 粗针1.5-4mm<sup>2</sup>, 细针0.5-4mm<sup>2</sup> C2: 粗针6-10mm<sup>2</sup>, 细针0.5-4mm<sup>2</sup> C3: 粗针10-16mm<sup>2</sup>, 细针0.5-4mm<sup>2</sup> (型号自带6pin插孔)</p>	<p>针座</p>



现场可接线连接器	型号	订货号	特性描述	针脚编号分布
<p>M40 8芯直线孔座</p>	<p>TNK8428-0/M42/C                      TNK8428-0/M42/C1                      TNK8428-0/M42/C2                      TNK8428-0/M42/C3</p>	<p>10095013                      10095080                      10093274                      10093275</p>	<p>铜锌合金                      M42电缆出线口                      可连接的电缆外径范围: 13-18/18~25mm                      压接连接 -40°C~125°C                      电源: 630 V, 55 A                      信号: 630 V, 10 A                      C: 粗针4-6mm<sup>2</sup>, 细针0.5-4mm<sup>2</sup>                      C1: 粗针1.5-4mm<sup>2</sup>, 细针0.5-4mm<sup>2</sup>                      C2: 粗针6-10mm<sup>2</sup>, 细针0.5-4mm<sup>2</sup>                      C3: 粗针10-16mm<sup>2</sup>, 细针0.5-4mm<sup>2</sup>                      (型号自带8pin插孔)</p>	<p>孔座</p>
<p>M40 8芯直线针座</p>	<p>TWZ8428-0/M42/C                      TWZ8428-0/M42/C1                      TWZ8428-0/M42/C2                      TWZ8428-0/M42/C3</p>	<p>10093276                      10095081                      10093277                      10093278</p>	<p>铜锌合金                      M42电缆出线口                      可连接的电缆外径范围: 13-18/18~25mm                      压接连接 -40°C~125°C                      电源: 630 V, 55 A                      信号: 630 V, 10 A                      C: 粗针4-6mm<sup>2</sup>, 细针0.5-4mm<sup>2</sup>                      C1: 粗针1.5-4mm<sup>2</sup>, 细针0.5-4mm<sup>2</sup>                      C2: 粗针6-10mm<sup>2</sup>, 细针0.5-4mm<sup>2</sup>                      C3: 粗针10-16mm<sup>2</sup>, 细针0.5-4mm<sup>2</sup>                      (型号自带8pin插针)</p>	<p>针座</p>
<p>M40 细插孔</p>	TKX0.5-4-C.8428	10093279	接线范围: 0.5-4mm <sup>2</sup>	
<p>M40 细插针</p>	TZX0.5-4-C.8428	10093280	接线范围: 0.5-4mm <sup>2</sup>	
<p>M40 插孔</p>	<p>TK1.5-4-C1.8428                      TK4-6-C.8428                      TK6-10-C2.8428                      TK10-16-C3.8428</p>	<p>10093281                      10093282                      10093283                      10093284</p>	<p>接线范围: 1.5-4mm<sup>2</sup>                      接线范围: 4-6mm<sup>2</sup>                      接线范围: 6-10mm<sup>2</sup>                      接线范围: 10-16mm<sup>2</sup></p>	
<p>M40 插针</p>	<p>TZ1.5-4-C1.8428                      TZ4-6-C.8428                      TZ6-10-C2.8428                      TZ10-16-C3.8428</p>	<p>10093285                      10093286                      10093287                      10093288</p>	<p>接线范围: 1.5-4mm<sup>2</sup>                      接线范围: 4-6mm<sup>2</sup>                      接线范围: 6-10mm<sup>2</sup>                      接线范围: 10-16mm<sup>2</sup></p>	





## ■ 1-3/8工业连接器

## 1-3/8"连接器型号命名规则

### 预铸式连接器命名规则

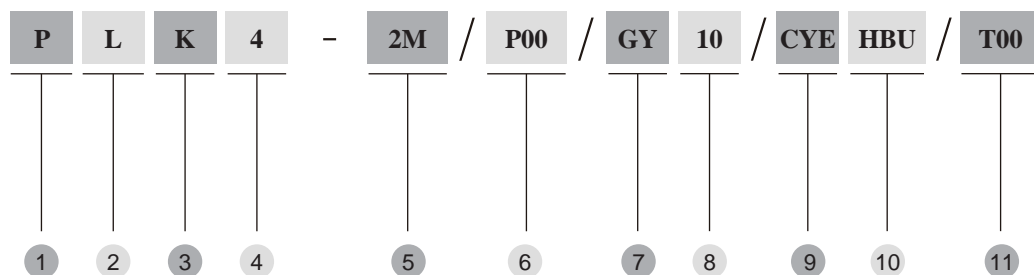

- |   |   |  |
|---|---|--|
| <p>1 P 1-3/8" 连接器</p> <p>2 Blank 直线型<br/>L 直角型</p> <p>3 K 孔座<br/>Z 针座</p> <p>4 针脚数<br/>编号分配</p> <p>5 电缆长度 [m]</p> | <p>6 电缆材质代码<br/>参考电缆型号说明</p> <p>7 电缆颜色<br/>Blank 标准色<br/>YE 黄色</p> <p>8 电缆线规<br/>Blank 标准线规 12AWG<br/>10 10AWG<br/>14 14AWG</p> | <p>9 针托颜色<br/>Blank 标准色黑色<br/>CYE 黄色针托</p> <p>10 预铸接头颜色<br/>Blank 标准色黑色<br/>HRD 红色预铸头</p> <p>11 特殊规格定制</p> |
|---|---|--|

### 双端预铸型号举例



PK3 PZ3-\*M/P00

### 法兰连接器命名规则

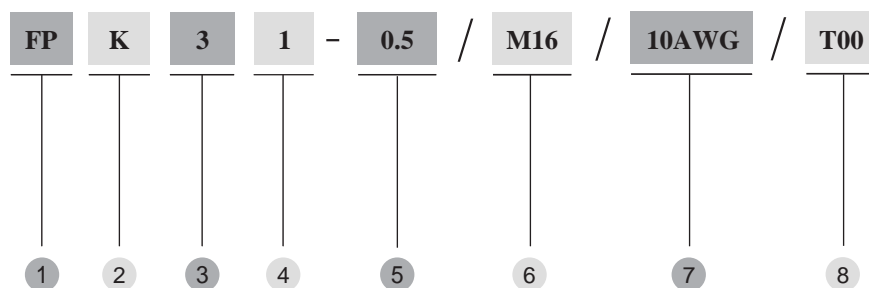

- |   |  |  |
|---|--|--|
| <p>1 FP 1-3/8" 法兰连接器</p> <p>2 K 孔座<br/>Z 针座</p> <p>3 针脚数<br/>编号分配</p> | <p>4 固定方式<br/>1 前端拧紧型<br/>2 后端拧紧型</p> <p>5 0.5 尾线长度0.5m<br/>L 导线焊接触点<br/>P PCB焊接触点</p> <p>6 连接螺纹规格<br/>Blank 1/2-14NPT<br/>M16 M16×1.5</p> | <p>7 线规<br/>Blank 标准线规 12AWG<br/>14AWG<br/>10AWG</p> <p>8 特殊规格定制</p> |
|---|--|--|

## 1-3/8"预铸式连接器

- 预铸接头:TPU材质,黑色
- 锁紧螺母:黄铜镀镍
- 针托:TPU材质,黑色
- 触点:黄铜镀金
- 防护等级:IP67
- 电流等级:18A/25A/30A
- 电压等级:600V
- 绝缘电阻: $\geq 10^9 \Omega$
- 接触电阻: $\leq 5m\Omega$
- 污染等级:3
- 使用环境温度:-40~+80 °C
- 可插拔寿命:最小100次
- 允许预铸线缆最大外径: $\varnothing 17.7$



预铸式连接器	型号	订货号	电缆	针脚编号分布
直线孔座PK..** 	PK3-2M/P00 PK3-5M/P00 PK3-10M/P00	10100500 10100501 10100502	黑色PVC电缆 3x12AWG(3x4mm <sup>2</sup> ) Ø10.6mm 电缆型号: 58459911-*M	孔座 1.BK 2.GN 3.WH
直线针座PZ..** 	PZ3-2M/P00 PZ3-5M/P00 PZ3-10M/P00	10100503 10100504 10100505	黑色PVC电缆 3x12AWG(3x4mm <sup>2</sup> ) Ø10.6mm 电缆型号: 58459911-*M	针座 1.BK 2.GN 3.WH
直线孔座PK..** 	PK4-2M/P00 PK4-5M/P00 PK4-10M/P00	10100506 10100507 10100508	黑色PVC电缆 4x12AWG(4x4mm <sup>2</sup> ) Ø11.5mm 电缆型号: 58462911-*M	孔座 1.BK 2.GN 3.RD 4.WH
直线针座PZ..** 	PZ4-2M/P00 PZ4-5M/P00 PZ4-10M/P00	10100509 10100510 10100511	黑色PVC电缆 4x12AWG(4x4mm <sup>2</sup> ) Ø11.5mm 电缆型号: 58462911-*M	针座 1.BK 2.GN 3.RD 4.WH

\* 标准长度为2/5/10米,可订制任意长度

\*\* 标准锁紧螺母材质为黄铜镀镍

# 1-3/8" T型头电源、法兰连接器

- 预铸接头:TPU材质,黑色
- 锁紧螺母:黄铜镀镍
- 针托:TPU材质,黑色
- 触点:黄铜镀金
- 电流等级:30A
- 电压等级:600V
- 绝缘电阻: $\geq 10^9 \Omega$
- 接触电阻: $\leq 5m\Omega$
- 污染等级:3
- 使用环境温度: $-30 \sim +90 \text{ }^\circ\text{C}$
- 可插拔寿命:最小100次
- 防护等级:IP67



预铸式连接器	型号	订货号	接线图
	PZ3-2PK3	10035177	
	PZ4-2PK4	10100513	
	FPK32-0.5	10046100	
	FPK42-0.5	10046101	
	FPZ32-0.5	10046102	
	FPZ42-0.5	10046103	

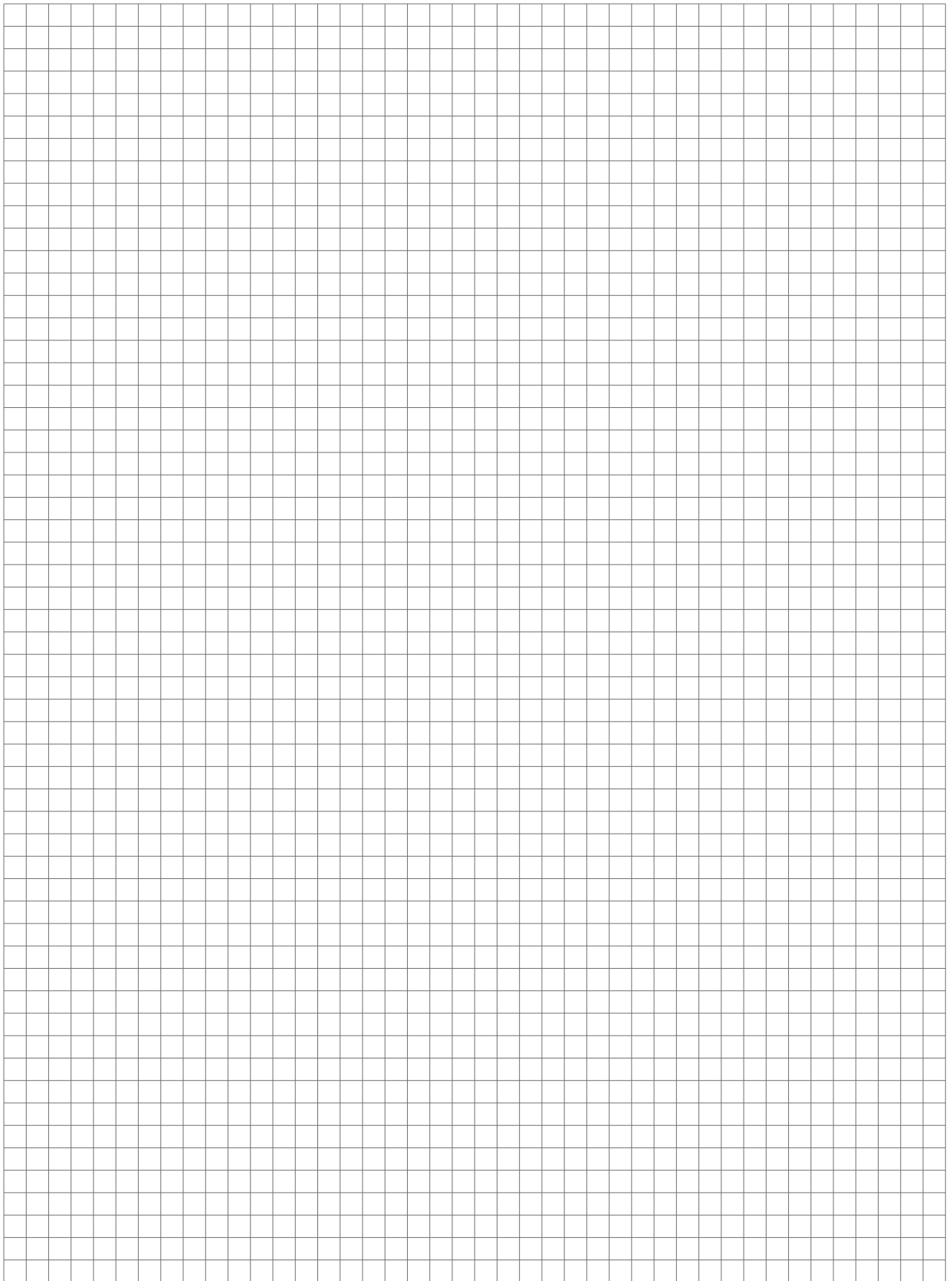
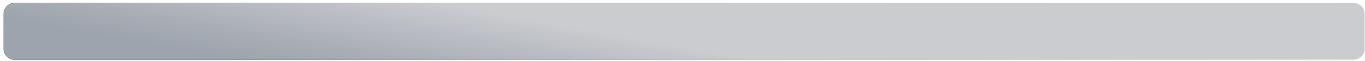



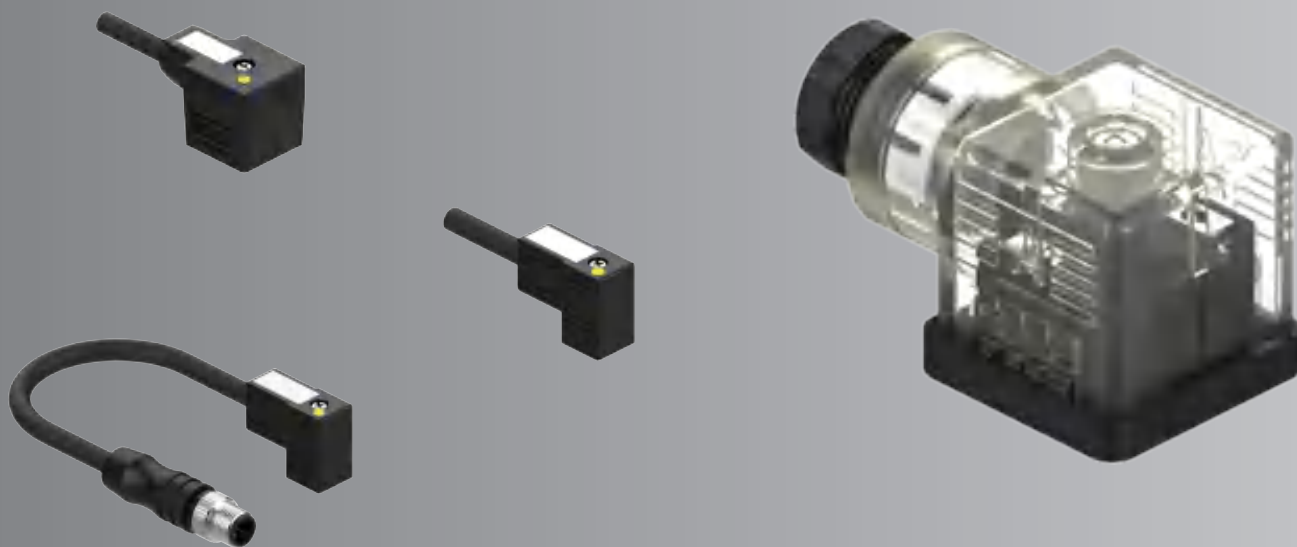

## ■ 阀式连接器

# 阀式连接器型号命名规则

## 预铸式连接器命名规则

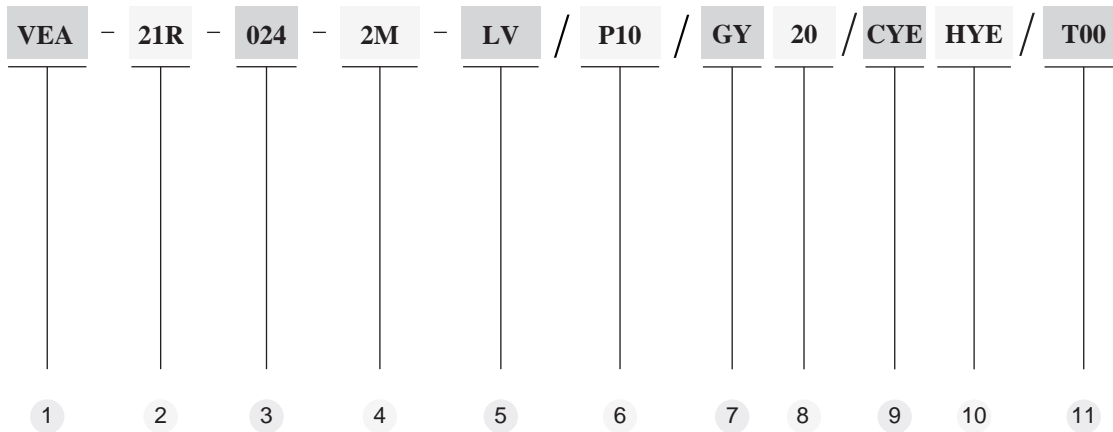

1 阀式连接器类型 (根据EN175301-803标准)

VA A型  
VEA A型  
VB B型  
VEBI B型  
VEC C型  
VECI CI型

2 触点间距及类型

21 2触点+1地  
31 3触点+1地  
32 3触点+1地  
21R 2触点+1地 (180°反向)

3 电压等级

024 24VDC  
110 110VDC  
220 220VAC

4 出线方式

2M 电缆出线2m  
M12/2M M12连接器带2m电缆  
M12L/2M M12弯头连接器带2m电缆

5 指示灯

Blank 无LED灯显示、无线路保护  
L LED灯显示、无线路保护  
LV LED灯显示和线路保护

6 线缆材质代码

Blank PVC  
P10 PUR

7 电缆颜色

Blank 标准色  
GY 灰色

8 电缆线规

Blank 标准线规18AWG  
20 20AWG

9 针托颜色

Blank 标准色黑色  
CYE 黄色针托

10 预铸接头颜色

Blank 标准色黑色  
HYE 黄色预铸头

11 特殊规格定制

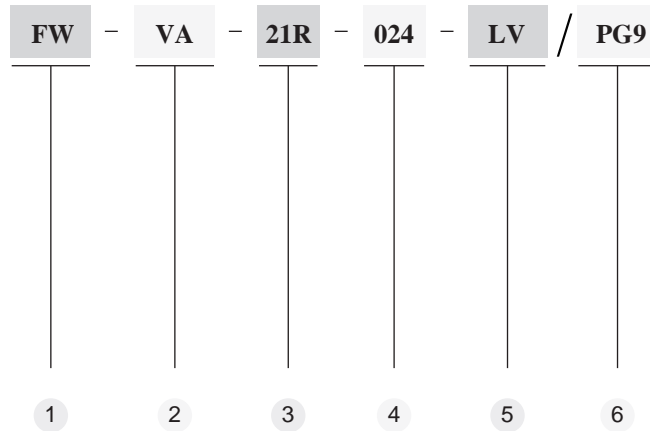

- 1 FW 阀式现场可接线连接器
- 2 阀式连接器类型  
 VA A型  
 VB B型  
 VBI BI型  
 VC C型  
 VCI CI型
- 3 触点间距及类型  
 21 2触点+1地  
 22 2触点+2地  
 31 3触点+1地

- 4 电压等级  
 024 24VDC  
 110 110VDC  
 220 220VAC
- 5 指示灯  
 Blank 无LED灯显示、无线路保护  
 LV LED灯显示和线路保护  
 L LED灯显示、无线路保护
- 6 后端连接方式  
 PG7 可连接的电缆外径范围4-6 mm  
 PG9 可连接的电缆外径范围6-8 mm  
 PG11 可连接的电缆外径范围8-11 mm

# A型阀式连接器

- 电缆材质: PVC、PUR  
特殊材质可指定
- 阀外壳材质: PA6+GF
- 预铸接头材质: TPU
- 针托材质: TPU
- 触点: 铜合金镀银
- 防护等级: IP67
- 针数: 2针+接地
- 污染等级: 3
- 使用环境温度: -40~+80°C



针脚排布	型号	订货号	电缆	线路图
	VEA21-024-2M-LV VEA21-110-2M-LV VEA21-220-2M-LV	10061300 10061301 10061302	黑色PVC电缆 3x18AWG (3x0.75mm <sup>2</sup> ) Ø6.0mm 电缆型号: 58534161-*M	
	VEA21-024-2M-L VEA21-110-2M-L VEA21-220-2M-L	10061303 10061304 10061305	黑色PVC电缆 3x18AWG (3x0.75mm <sup>2</sup> ) Ø6.0mm 电缆型号: 58534161-*M	
	VEA21-024-2M VEA21-110-2M VEA21-220-2M	10061306 10061307 10061308	黑色PVC电缆 3x18AWG (3x0.75mm <sup>2</sup> ) Ø6.0mm 电缆型号: 58534161-*M	
	VEA21-024-M12/2M-LV VEA21-110-M12/2M-LV VEA21-220-M12/2M-LV	10061309 10061310 10061311	黑色PVC电缆 3x18AWG (3x0.75mm <sup>2</sup> ) Ø6.0mm 电缆型号: 58534161-*M	
	VEA21-024-M12/2M-L VEA21-110-M12/2M-L VEA21-220-M12/2M-L	10061312 10061313 10061314	黑色PVC电缆 3x18AWG (3x0.75mm <sup>2</sup> ) Ø6.0mm 电缆型号: 58534161-*M	
	VEA21-024-M12/2M VEA21-110-M12/2M VEA21-220-M12/2M	10061315 10061316 10061317	黑色PVC电缆 3x18AWG (3x0.75mm <sup>2</sup> ) Ø6.0mm 电缆型号: 58534161-*M	

\* 标准长度为2/5/10米,可订制任意长度

- 电缆材质: PVC、PUR  
特殊材质可指定
- 针数: 3针+接地
- 污染等级:3
- 阀外壳材质: PA6+GF
- 使用环境温度:-40~+80°C
- 预铸接头材质: TPU
- 针托材质: TPU
- 触点: 铜合金镀银
- 防护等级: IP67



针脚排布	型号	订货号	电缆	线路图
	VEA31-024-2M-LV VEA31-110-2M-LV VEA31-220-2M-LV	10061318 10061319 10061320	黑色PVC电缆 4x18AWG (4x0.75mm <sup>2</sup> ) Ø6.0mm 电缆型号: 58535161-*M	
	VEA31-024-2M-L VEA31-110-2M-L VEA31-220-2M-L	10061321 10061322 10061323	黑色PVC电缆 4x18AWG (4x0.75mm <sup>2</sup> ) Ø6.0mm 电缆型号: 58535161-*M	
	VEA31-024-2M VEA31-110-2M VEA31-220-2M	10061324 10061325 10061326	黑色PVC电缆 4x18AWG (4x0.75mm <sup>2</sup> ) Ø6.0mm 电缆型号: 58535161-*M	
	VEA31-024-M12/2M-LV VEA31-110-M12/2M-LV	10061327 10061328	黑色PVC电缆 4x18AWG (4x0.75mm <sup>2</sup> ) Ø6.0mm 电缆型号: 58535161-*M	
	VEA31-024-M12/2M-L VEA31-110-M12/2M-L VEA31-220-M12/2M-L	10061329 10061330 10061331	黑色PVC电缆 4x18AWG (4x0.75mm <sup>2</sup> ) Ø6.0mm 电缆型号: 58535161-*M	
	VEA31-024-M12/2M VEA31-110-M12/2M VEA31-220-M12/2M	10061332 10061333 10061334	黑色PVC电缆 4x18AWG (4x0.75mm <sup>2</sup> ) Ø6.0mm 电缆型号: 58535161-*M	

\* 标准长度为2/5/10米,可订制任意长度

# A型阀式连接器

- 电缆材质: PVC、PUR  
特殊材质可指定
- 阀外壳材质: PA6+GF
- 预铸接头材质: TPU
- 针托材质: TPU
- 触点: 铜合金镀银
- 防护等级: IP67
- 针数: 4针+1接地
- 污染等级: 3
- 使用环境温度: -40~+80°C



针脚排布	型号	订货号	电缆	线路图
   	VA32-024-2M-L VA32-110-2M-L VA32-220-2M-L	10061970 10061980 10061990	黑色PVC电缆 5x20AWG (5x0.5mm <sup>2</sup> ) Ø6.0mm 电缆型号: 58033151-*M	
	VA32-024-M12/2M-L VA32-110-M12/2M-L VA32-220-M12/2M-L	10061143 10062120 10062130	黑色PVC电缆 5x20AWG (5x0.5mm <sup>2</sup> ) Ø6.0mm 电缆型号: 58033151-*M	

\* 标准长度为2/5/10米,可订制任意长度

- 电缆材质: PVC、PUR  
特殊材质可指定
- 针数: 2针+接地
- 污染等级:3
- 阀外壳材质: PA6+GF
- 使用环境温度:-40~+80°C
- 预铸接头材质: TPU
- 针托材质: TPU
- 触点: 铜合金镀银
- 防护等级: IP67



针脚排布	型号	订货号	电缆	线路图
	VB21-024-2M-LV VB21-110-2M-LV	10062000 10062001	黑色PVC电缆 3x18AWG (3x0.75mm <sup>2</sup> ) Ø6.0mm 电缆型号: 58534161-*M	
	VB21-024-2M-L VB21-110-2M-L VB21-220-2M-L	10062020 10062021 10062022	黑色PVC电缆 3x18AWG (3x0.75mm <sup>2</sup> ) Ø6.0mm 电缆型号: 58534161-*M	
	VB21-024-2M VB21-110-2M VB21-220-2M	10062050 10062051 10062052	黑色PVC电缆 3x18AWG (3x0.75mm <sup>2</sup> ) Ø6.0mm 电缆型号: 58534161-*M	
	VB21-024-M12/2M-LV VB21-110-M12/2M-LV	10062010 10062011	黑色PVC电缆 3x18AWG (3x0.75mm <sup>2</sup> ) Ø6.0mm 电缆型号: 58534161-*M	
	VB21-024-M12/2M-L VB21-110-M12/2M-L VB21-220-M12/2M-L	10062030 10062031 10062032	黑色PVC电缆 3x18AWG (3x0.75mm <sup>2</sup> ) Ø6.0mm 电缆型号: 58534161-*M	
	VB21-024-M12/2M VB21-110-M12/2M VB21-220-M12/2M	10062060 10062061 10062062	黑色PVC电缆 3x18AWG (3x0.75mm <sup>2</sup> ) Ø6.0mm 电缆型号: 58534161-*M	

\* 标准长度为2/5/10米,可订制任意长度

# B型阀式连接器

- 电缆材质: PVC、PUR  
特殊材质可指定
- 针数: 2针+接地180°反向
- 污染等级: 3
- 阀外壳材质: PA6+GF
- 使用环境温度: -40~+80°C
- 预铸接头材质: TPU
- 针托材质: TPU
- 触点: 铜合金镀银
- 防护等级: IP67



针脚排布	型号	订货号	电缆	线路图
<p>Technical drawings showing dimensions: 21.8mm (width), 44.8mm (height), 30.4mm (width), 10mm (width), and 8.75mm (height). Components include LED, 螺钉 (screw), 标记牌 (label), M3x32 (thread), and Ground. A pin layout diagram shows pins 1, 2, 3, 4, 5 with a 180-degree rotation between pins 1 and 2.</p>	VB21R-024-2M-LV VB21R-110-2M-LV	10062074 10062075	黑色PVC电缆 3x18AWG (3x0.75mm <sup>2</sup> ) Ø6.0mm 电缆型号: 58534161-*M	<p>Valve circuit diagram showing pins 1 and 2 connected to BK1 and BK2 respectively. A yellow LED is connected between BK1 and BK2. Ground is connected to GN/YE.</p>
	VB21R-024-2M-L VB21R-110-2M-L VB21R-220-2M-L	10062076 10062077 10062078	黑色PVC电缆 3x18AWG (3x0.75mm <sup>2</sup> ) Ø6.0mm 电缆型号: 58534161-*M	<p>Valve circuit diagram showing pins 1 and 2 connected to BK1 and BKW respectively. A yellow LED is connected between BK1 and BKW. Ground is connected to GN/YE.</p>
	VB21R-024-2M VB21R-110-2M VB21R-220-2M	10062079 10062080 10062081	黑色PVC电缆 3x18AWG (3x0.75mm <sup>2</sup> ) Ø6.0mm 电缆型号: 58534161-*M	<p>Valve circuit diagram showing pins 1 and 2 connected to BK1 and BK2 respectively. Ground is connected to GN/YE.</p>
	VB21R-024-M12/2M-LV VB21R-110-M12/2M-LV	10062082 10062083	黑色PVC电缆 3x18AWG (3x0.75mm <sup>2</sup> ) Ø6.0mm 电缆型号: 58534161-*M	<p>Valve circuit diagram showing pins 1 and 2 connected to M12 pins 4 (BK1) and 3 (BK2) respectively. A yellow LED is connected between M12 pins 4 and 3. Ground is connected to M12 pin 5 (GN/YE).</p>
	VB21R-024-M12/2M-L VB21R-110-M12/2M-L VB21R-220-M12/2M-L	10062084 10062085 10062086	黑色PVC电缆 3x18AWG (3x0.75mm <sup>2</sup> ) Ø6.0mm 电缆型号: 58534161-*M	<p>Valve circuit diagram showing pins 1 and 2 connected to M12 pins 4 (BK1) and 3 (BK2) respectively. A yellow LED is connected between M12 pins 4 and 3. Ground is connected to M12 pin 5 (GN/YE).</p>
	VB21R-024-M12/2M VB21R-110-M12/2M VB21R-220-M12/2M	10062087 10062088 10062089	黑色PVC电缆 3x18AWG (3x0.75mm <sup>2</sup> ) Ø6.0mm 电缆型号: 58534161-*M	<p>Valve circuit diagram showing pins 1 and 2 connected to M12 pins 4 (BK1) and 3 (BK2) respectively. Ground is connected to M12 pin 5 (GN/YE).</p>

\* 标准长度为2/5/10米,可订制任意长度

- 电缆材质: PVC、PUR  
特殊材质可指定
- 针数: 2针+接地
- 污染等级:3
- 阀外壳材质: PA6+GF
- 使用环境温度:-40~+80°C
- 预铸接头: TPU
- 针托材质: TPU
- 触点: 铜合金镀银
- 防护等级: IP67



针脚排布	型号	订货号	电缆	线路图
	VEBI21-024-2M-LV VEBI21-110-2M-LV VEBI21-220-2M-LV	10068000 10068001 10068002	黑色PVC电缆 3x18AWG (3x0.75mm <sup>2</sup> ) Ø6.0mm 电缆型号: 58534161-*M	
	VEBI21-024-2M-L VEBI21-110-2M-L VEBI21-220-2M-L	10068003 10068004 10068005	黑色PVC电缆 3x18AWG (3x0.75mm <sup>2</sup> ) Ø6.0mm 电缆型号: 58534161-*M	
	VEBI21-024-2M VEBI21-110-2M VEBI21-220-2M	10068006 10068007 10068008	黑色PVC电缆 3x18AWG (3x0.75mm <sup>2</sup> ) Ø6.0mm 电缆型号: 58534161-*M	
	VEBI21-024-M12/2M-LV VEBI21-110-M12/2M-LV VEBI21-220-M12/2M-LV	10068009 10068010 10068011	黑色PVC电缆 3x18AWG (3x0.75mm <sup>2</sup> ) Ø6.0mm 电缆型号: 58534161-*M	
	VEBI21-024-M12/2M-L VEBI21-110-M12/2M-L VEBI21-220-M12/2M-L	10068012 10068013 10068014	黑色PVC电缆 3x18AWG (3x0.75mm <sup>2</sup> ) Ø6.0mm 电缆型号: 58534161-*M	
	VEBI21-024-M12/2M VEBI21-110-M12/2M VEBI21-220-M12/2M	10068015 10068016 10068017	黑色PVC电缆 3x18AWG (3x0.75mm <sup>2</sup> ) Ø6.0mm 电缆型号: 58534161-*M	

\* 标准长度为2/5/10米,可订制任意长度

# BI型阀式接口

- 电缆材质: PVC、PUR  
特殊材质可指定
- 针数: 2针+接地180°反向
- 污染等级:3
- 阀外壳材质: PA6+GF
- 使用环境温度:-40~+80°C
- 预铸接头材质: TPU
- 针托材质: TPU
- 触点: 铜合金镀银
- 防护等级: IP67



针脚排布	型号	订货号	电缆	线路图
	VEBI21R-024-2M-LV VEBI21R-110-2M-LV VEBI21R-220-2M-LV	10068018 10068019 10068020	黑色PVC电缆 3x18AWG (3x0.75mm <sup>2</sup> ) Ø6.0mm 电缆型号: 58534161-*M	
	VEBI21R-024-2M-L VEBI21R-110-2M-L VEBI21R-220-2M-L	10068021 10068022 10068023	黑色PVC电缆 3x18AWG (3x0.75mm <sup>2</sup> ) Ø6.0mm 电缆型号: 58534161-*M	
	VEBI21R-024-2M VEBI21R-110-2M VEBI21R-220-2M	10068024 10068025 10068026	黑色PVC电缆 3x18AWG (3x0.75mm <sup>2</sup> ) Ø6.0mm 电缆型号: 58534161-*M	
	VEBI21R-024-M12/2M-LV VEBI21R-110-M12/2M-LV VEBI21R-220-M12/2M-LV	10068027 10068028 10068029	黑色PVC电缆 3x18AWG (3x0.75mm <sup>2</sup> ) Ø6.0mm 电缆型号: 58534161-*M	
	VEBI21R-024-M12/2M-L VEBI21R-110-M12/2M-L VEBI21R-220-M12/2M-L	10068030 10068031 10068032	黑色PVC电缆 3x18AWG (3x0.75mm <sup>2</sup> ) Ø6.0mm 电缆型号: 58534161-*M	
	VEBI21R-024-M12/2M VEBI21R-110-M12/2M VEBI21R-220-M12/2M	10068033 10068034 10068035	黑色PVC电缆 3x18AWG (3x0.75mm <sup>2</sup> ) Ø6.0mm 电缆型号: 58534161-*M	

\* 标准长度为2/5/10米,可订制任意长度

- 电缆材质: PVC、PUR  
特殊材质可指定
- 针数: 2针+接地
- 污染等级:3
- 阀外壳材质: PA6+GF
- 使用环境温度:-40~+80°C
- 预铸接头材质: TPU
- 针托材质: TPU
- 触点: 铜合金镀银
- 防护等级: IP67



针脚排布	型号	订货号	电缆	线路图
	VEC21-024-2M-LV	10064217	黑色PVC电缆 3x18AWG (3x0.75mm <sup>2</sup> ) Ø6.0mm 电缆型号: 58534161-*M	
	VEC21-024-2M-L	10064200	黑色PVC电缆 3x18AWG (3x0.75mm <sup>2</sup> ) Ø6.0mm 电缆型号: 58534161-*M	
	VEC21-024-2M VEC21-110-2M VEC21-220-2M	10064201 10064202 10064203	黑色PVC电缆 3x18AWG (3x0.75mm <sup>2</sup> ) Ø6.0mm 电缆型号: 58534161-*M	
	VEC21-024-M12/2M-LV	10064204	黑色PVC电缆 3x18AWG (3x0.75mm <sup>2</sup> ) Ø6.0mm 电缆型号: 58534161-*M	
	VEC21-024-M12/2M-L	10064205	黑色PVC电缆 3x18AWG (3x0.75mm <sup>2</sup> ) Ø6.0mm 电缆型号: 58534161-*M	
	VEC21-024-M12/2M VEC21-110-M12/2M VEC21-220-M12/2M	10064206 10064207 10064208	黑色PVC电缆 3x18AWG (3x0.75mm <sup>2</sup> ) Ø6.0mm 电缆型号: 58534161-*M	

\* 标准长度为2/5/10米,可订制任意长度

# CI型阀式接器

- 电缆材质: PVC、PUR  
特殊材质可指定
- 针数: 2针+接地
- 污染等级:3
- 阀外壳材质: PA6+GF
- 使用环境温度:-40~+80°C
- 预铸接头材质: TPU
- 针托材质: TPU
- 触点: 铜合金镀银
- 防护等级: IP67



针脚排布	型号	订货号	电缆	线路图
	VECI21-024-2M-LV	10064209	黑色PVC电缆 3x18AWG (3x0.75mm <sup>2</sup> ) Ø6.0mm 电缆型号: 58534161-*M	
	VECI21-024-2M-L	10064210	黑色PVC电缆 3x18AWG (3x0.75mm <sup>2</sup> ) Ø6.0mm 电缆型号: 58534161-*M	
	VECI21-024-2M VECI21-110-2M VECI21-220-2M	10064211 10064300 10064301	黑色PVC电缆 3x18AWG (3x0.75mm <sup>2</sup> ) Ø6.0mm 电缆型号: 58534161-*M	
	VECI21-024-M12/2M-LV	10064302	黑色PVC电缆 3x18AWG (3x0.75mm <sup>2</sup> ) Ø6.0mm 电缆型号: 58534161-*M	
	VECI21-024-M12/2M-L	10064303	黑色PVC电缆 3x18AWG (3x0.75mm <sup>2</sup> ) Ø6.0mm 电缆型号: 58534161-*M	
	VECI21-024-M12/2M VECI21-110-M12/2M VECI21-220-M12/2M	10064304 10064305 10064306	黑色PVC电缆 3x18AWG (3x0.75mm <sup>2</sup> ) Ø6.0mm 电缆型号: 58534161-*M	

\* 标准长度为2/5/10米,可订制任意长度

## A型现场可接线阀式连接器

- 外壳材质: PC
- 触点: 铜合金镀银
- 针托材质: TPU
- 防护等级: IP67
- 可连接的电缆外径范围: PG9(6-8)mm, PG11(8-11)mm
- 针数: 2针+1接地
- 污染等级:3
- 使用环境温度:-30...+90°C



针脚排布	型号	订货号	特性描述	线路图
	FW-VA21-024-LV/PG9	10066012	LED灯显示 线路保护 2针+接地 PG9 电缆出线口 可连接的电缆外径范围	
	FW-VA21-110-LV/PG9	10066013		
	FW-VA21-220-LV/PG9	10066014		
	FW-VA21-024-LV/PG11	10066015		6-8 mm
	FW-VA21-110-LV/PG11	10066002		PG11 电缆出线口
	FW-VA21-220-LV/PG11	10066016		可连接的电缆外径范围 8-10 mm
	FW-VA21-024-L/PG9	10066010	LED灯显示 无线路保护 2针+接地 PG9 电缆出线口 可连接的电缆外径范围	
	FW-VA21-110-L/PG9	10066017		
	FW-VA21-220-L/PG9	10066018		
	FW-VA21-024-L/PG11	10066019	6-8 mm	
	FW-VA21-110-L/PG11	10066020	PG11 电缆出线口	
	FW-VA21-220-L/PG11	10066021	可连接的电缆外径范围 8-10 mm	
	FW-VA21/PG9	10066022	无LED灯显示 无线路保护 2针+接地 PG9 电缆出线口 可连接的电缆外径范围	
	FW-VA21/PG11	10066001	6-8 mm PG11 电缆出线口 可连接的电缆外径范围 8-10 mm	

## A型现场可接线阀式连接器

- 外壳材质: PC
- 触点: 铜合金镀银
- 针托材质: TPU
- 防护等级: IP67
- 可连接的电缆外径范围: PG9(6-8)mm, PG11(8-11)mm
- 针数: 3针+1接地
- 污染等级: 3
- 使用环境温度: -30...+70°C



针脚排布	型号	订货号	特性描述	线路图
	FW-VA31-024-LV/PG9	10066035	LED灯显示 线路保护 3针+1接地 PG9 电缆出线口 可连接的电缆外径范围	
	FW-VA31-110-LV/PG9	10066036	6-8 mm	
	FW-VA31-220-LV/PG9	10066037	PG11 电缆出线口 可连接的电缆外径范围	
	FW-VA31-024-LV/PG11	10066003	8-10 mm	
	FW-VA31-110-LV/PG11	10066038		
		FW-VA31-024-L/PG9	10066040	LED灯显示 无线路保护 3针+1接地 PG9 电缆出线口 可连接的电缆外径范围
FW-VA31-110-L/PG9		10066041	6-8 mm	
	FW-VA31-024-L/PG11	10066008	PG11 电缆出线口 可连接的电缆外径范围	
	FW-VA31-110-L/PG11	10066043	8-10 mm	
FW-VA31-220-L/PG11	10066044			
	FW-VA31/PG9	10066011	无LED灯显示 无线路保护 3针+1接地 PG9 电缆出线口 可连接的电缆外径范围	
	FW-VA31/PG11	10066009	6-8 mm PG11 电缆出线口 可连接的电缆外径范围	
			8-10 mm	

## C型现场可接线阀式连接器

- 外壳材质: PC
- 触点: 铜合金镀银
- 针托材质: TPU
- 防护等级: IP67/TPU
- 可连接的电缆外径范围: PG7(4-6)mm
- 针数: 2针+1接地
- 污染等级:3
- 使用环境温度:-30...+90°C



针脚排布	型号	订货号	特性描述	线路图
	FW-VC21-024-L/PG7	10066053	LED灯显示 无线路保护 2针+1接地 PG7 电缆出线口 可连接的电缆外径范围 4-6 mm	
	FW-VC21/PG7 FW-VC21/PG7/BK	10066050 12040643	无LED灯显示 无线路保护 2针+1接地 PG7 电缆出线口 可连接的电缆外径范围 4-6 mm	



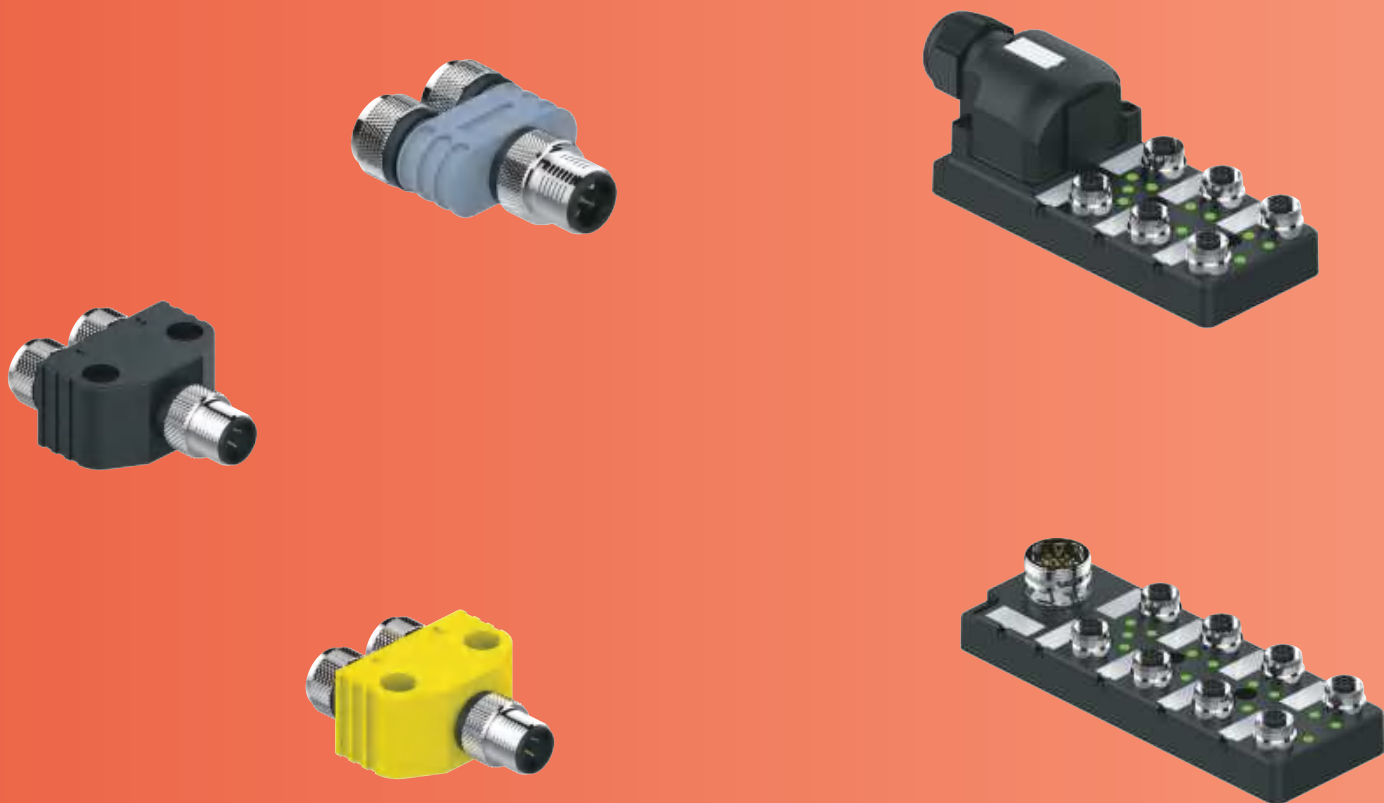

## ■ 分线器 & 分线盒

# 分线器/分线盒型号命名规则

## 分线器

<b>YK</b>	<b>4</b>	-	<b>2</b>	<b>EK</b>	<b>3</b>	-	<b>1M</b>	-	<b>1M</b>	/	<b>P00</b>	/	<b>YE</b>	/	<b>HYE</b>	/	<b>BST25</b>	/	<b>T00</b>
1	2		3	4	5		6		7		8		9		10		11		12
1	<b>YZ</b> 紧凑型针座M12x1 <b>YK</b> 紧凑型孔座M12x1 <b>YHZ</b> 紧凑型安装款针座M12x1 <b>YHK</b> 紧凑型安装款孔座M12x1 <b>YSZ</b> 紧凑型针座M8x1 <b>YSK</b> 紧凑型孔座M8x1 <b>YHSZ</b> 紧凑型安装款针座M8x1 <b>YHSK</b> 紧凑型安装款孔座M8x1 <b>YWZ</b> 宽型针座M12x1 <b>YWK</b> 宽型孔座M12x1 <b>YVZ</b> 窄型针座M12x1 <b>YVK</b> 窄型孔座M12x1 <b>YVSZ</b> 窄型针座M8x1 <b>YVSK</b> 窄型孔座M8x1 <b>YMZ</b> 窄型安装款针座M12x1 <b>YMK</b> 窄型安装款孔座M12x1 <b>YFWK</b> 宽型法兰孔座M12x1 <b>YFWZ</b> 宽型法兰针座M12x1					3	<b>分支连接数</b> Blank 适配器		9	<b>电缆颜色</b> Blank 标准色黑色 YE 黄色 (定制化) GY 灰色 (定制化)									
2	<b>针脚数</b> 编号分配					4	<b>EK</b> M12x1孔座 <b>EZ</b> M12x1针座 <b>FEK</b> M12x1法兰孔座 <b>FEZ</b> M12x1法兰针座 <b>SK</b> M8x1孔座 <b>SZ</b> M8x1针座 <b>FSK</b> M8x1法兰孔座 <b>FSZ</b> M8x1法兰针座		10	<b>预铸接头颜色</b> Blank 标准色黑色 HYE 黄色预铸接头 (定制化) HBU 蓝色预铸接头 (定制化)									
						5	<b>针脚数</b> 编号分配		11	<b>标识套 (不带标记牌)</b> 默认每端插件1个 Blank 默认不带标识套 BST25 25mm长标识套									
						6	<b>分支1线缆长度[m]</b>		12	<b>特殊规格定制</b>									
						7	<b>分支2线缆长度[m]</b>												
						8	<b>线缆代码</b> 与M12 I/O类电缆代码一致												

## 分线盒

<b>JB</b>	<b>S</b>	<b>8</b>	<b>M12</b>	<b>S</b>	-	<b>4</b>	<b>P</b>	-	<b>J</b>	-	<b>R</b>	/	<b>P10</b>	/	<b>YE</b>	/	<b>T00</b>
1	2	3	4	5		6	7		8		9		10		11		12
1	<b>JB</b> 标准分线盒 <b>JBW</b> 宽型分线盒(M8分口)		5	<b>Blank</b> 无接地片 <b>S</b> 带接地片		9	<b>每分口信号数量</b> Blank 单信号 R 双信号										
2	<b>外壳材质</b> Blank 尼龙 (PA) S 铸铝		6	<b>针脚数</b> 编号分配		10	<b>直出线式电缆材质</b> Blank PVC P10 PUR										
3	<b>端口数量</b> 4 4分口 6 6分口 8 8分口 12 12分口		7	<b>LED指示灯类型</b> Blank 无LED P PNP N NPN		11	<b>直出线式电缆颜色</b> Blank 黑色 YE 黄色 GY 灰色										
4	<b>分口连接类型</b> M8,M12		8	<b>出线方式</b> Blank M23水平式 T M23垂直式 M12 M12垂直式 M16 M16垂直式 J 接线盒式 D2 直出2m电缆		12	<b>特殊规格定制</b>										

## M8/M12两分支紧凑型分线器

- 外壳材质: TPU材质, 黑色
- 锁紧螺母: 黄铜镀镍
- 针托: TPU材质, 黑色
- 触点: 黄铜镀金
- 密封圈: FPM/FKM
- 防护等级: IP67
- 使用环境温度: -30...+90°C
- 可插拔寿命: 最小100次



连接器类型	型号	订货号	接线图
	YSK4-2SZ3-2M-2M/P00 YSK4-2SZ3-5M-5M/P00 YSK4-2SZ3-10M-10M/P00	10014600 10084620 10084621	
	YSZ4-2SK3-2M-2M/P00 YSZ4-2SK3-5M-5M/P00 YSZ4-2SK3-10M-10M/P00	10014610 10084622 10084623	
	YK4-2EZ3-2M-2M/P00 YK4-2EZ3-5M-5M/P00 YK4-2EZ3-10M-10M/P00	10014000 10014181 10014606	
	YK4-2SZ3-2M-2M/P00 YK4-2SZ3-5M-5M/P00 YK4-2SZ3-10M-10M/P00	10014010 10014607 10014608	
	YZ4-2EK3-2M-2M/P00 YZ4-2EK3-5M-5M/P00 YZ4-2EK3-10M-10M/P00	10014020 10014021 10014022	
	YZ4-2SK3-2M-2M/P00 YZ4-2SK3-5M-5M/P00 YZ4-2SK3-10M-10M/P00	10014030 10014609 10014611	

\* 标准长度为2/5/10米,可订制任意长度

\*\* 标准锁紧螺母材质为黄铜镀镍

# M12两分支宽型分线器

- 外壳材质: TPU材质, 黑色
- 锁紧螺母: 黄铜镀镍
- 针托: TPU材质, 黑色
- 触点: 黄铜镀金
- 密封圈: FPM/FKM
- 防护等级: IP67
- 使用环境温度: -30...+90°C
- 可插拔寿命: 最小100次



连接器类型	型号	订货号	接线图
<p>Ø15锁紧螺母</p>	<p>YWZ4-2EK3 黑色 YWZ4-2EK3/HBU 蓝色 YWZ4-2EK3/HYE 黄色</p>	<p>10086000 10086014 10086012</p>	
<p>Ø15锁紧螺母</p>	<p>YWZ5-2EK4.5 黑色 YWZ5-2EK4.5/HBU 蓝色 YWZ5-2EK4.5/HYE 黄色</p>	<p>10086010 10086016 10086022</p>	
<p>Ø19锁紧螺母</p>	<p>YWZ4-2EK3/10 黑色 YWZ4-2EK3/HBU10 蓝色 YWZ4-2EK3/HYE10 黄色</p>	<p>10086008 10086015 10086023</p>	
<p>Ø19锁紧螺母</p>	<p>YWZ5-2EK4.5/10 黑色 YWZ5-2EK4.5/HBU10 蓝色 YWZ5-2EK4.5/HYE10 黄色</p>	<p>10086024 10086025 10086026</p>	

\* 标准长度为2/H5/H10米,可订制任意长度

\*\* 标准锁紧螺母材质为黄铜镀镍

## M12两分支窄型分线器

- 外壳材质: TPU材质, 黑色
- 锁紧螺母: 黄铜镀镍
- 针托: TPU材质, 黑色
- 触点: 黄铜镀金
- 密封圈: FPM/FKM
- 防护等级: IP67
- 使用环境温度: -30...+90°C
- 可插拔寿命: 最小100次



连接器类型	型号	订货号	接线图
	YVZ4-2EK3 黑色 YVZ4-2EK3/HBU 蓝色 YVZ4-2EK3/HYE 黄色	10086050 10086071 10086051	
	YVZ5-2EK4.5 黑色 YVZ5-2EK4.5/HBU 蓝色 YVZ5-2EK4.5/HYE 黄色	10086013 10086057 10086027	
	YVZ4-2SK3 黑色 YVZ4-2SK3/HBU 蓝色 YVZ4-2SK3/HYE 黄色	10086031 10086028 10086029	
	YWZ4-2M-2EK3-2M-2M/P00 YWZ4-5M-2EK3-5M-5M/P00	10084100 10014500	
	YWZ5-2M-2EK4.5-2M-2M/P00 YWZ5-5M-2EK4.5-5M-5M/P00	10086009 10086120	

\* 标准长度为2/5/10米,可订制任意长度

\*\* 标准锁紧螺母材质为黄铜镀镍

## M8四分口分线盒

- 外壳材质:尼龙,黑色
- 锁紧螺母:黄铜镀镍
- 针托:TPU材质,黑色
- 触点:黄铜镀金
- 密封圈:FPM/FKM,防护等级:IP67
- 负载:10~30VDC,6A总电流强度,2A分口电流强度,LED 10mA
- 使用环境温度:-30...+80°C
- 可插拔寿命:最小100次



外形尺寸 接线图

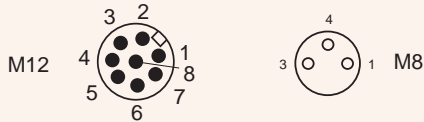
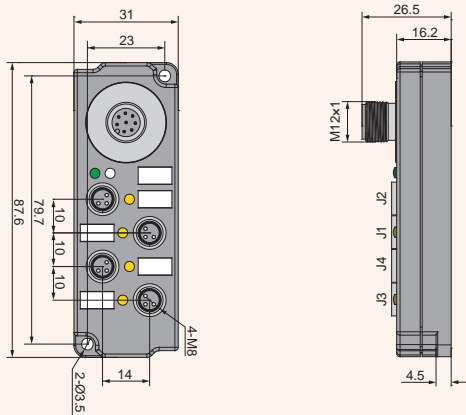

信号	M12 针脚号	M8 针脚号	适配电缆 线色
电源+	5	1	灰(GY)
电源-	7	3	蓝(BU)
J1	1	4	白(WH)
J2	2	4	棕(BN)
J3	3	4	绿(GN)
J4	4	4	黄(YE)

规格

型号 订货号

每分口1路信号  
不带LED显示灯  
垂直式M12根线连接器  
主线端适配插件:  
EK8-\*M/P00

JB4M8-3-M12  
10071130

每分口1路信号  
带PNP LED显示灯  
垂直式M12根线连接器  
主线端适配插件:  
EK8-\*M/P00

JB4M8-3P-M12  
10071131

\* 标准长度为2/5/10米,可订制任意长度

\*\* 标准锁紧螺母材质为黄铜镀镍

- 外壳材质:尼龙,黑色
- 锁紧螺母:黄铜镀镍
- 针托:TPU材质,黑色
- 触点:黄铜镀金
- 密封圈:FPM/FKM,防护等级:IP67
- 负载:10~30VDC,6A总电流强度,2A分口电流强度,LED 10mA
- 使用环境温度:-30...+80°C
- 可插拔寿命:最小100次



外形尺寸 接线图

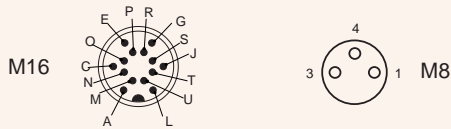
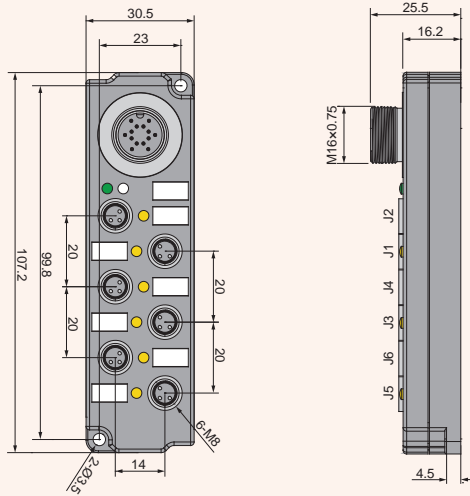

信号	M16 针脚号	M8 针脚号	适配电缆 线色
电源+	A/M	1	棕(BN)
电源-	L/U	3	蓝(BU)
J1	P	4	白(WH)
J2	J	4	绿(GN)
J3	T	4	黄(YE)
J4	S	4	灰(GY)
J5	G	4	粉(PK)
J6	R	4	红(RD)

规格

型号 订货号

每分口1路信号  
不带LED显示灯  
垂直式M16根线连接器  
主缆适配插件:  
DNK14-10-\*M/P00

JB6M8-3-M16  
10072150

每分口1路信号  
带PNP LED显示灯  
垂直式M16根线连接器  
主缆适配插件:  
DNK14-10-\*M/P00

JB6M8-3P-M16  
10072151

\* 标准长度为2/5/10米,可订制任意长度

\*\* 标准锁紧螺母材质为黄铜镀镍

# M8六分口分线盒

- 外壳材质:尼龙,黑色
- 锁紧螺母:黄铜镀镍
- 针托:TPU材质,黑色
- 触点:黄铜镀金
- 密封圈:FPM/FKM,防护等级:IP67
- 负载:10~30VDC,6A总电流强度,2A分口电流强度,LED 10mA
- 使用环境温度:-30...+80°C
- 可插拔寿命:最小100次



外形尺寸 接线图

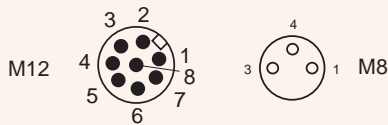
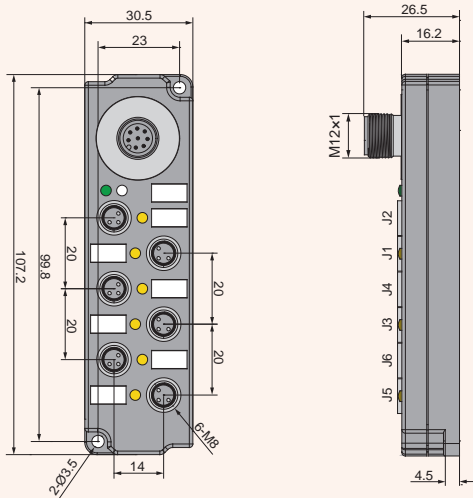

信号	M12 针脚号	M8 针脚号	适配电缆 线色
电源+	5	1	棕(BN)
电源-	7	3	蓝(BU)
J1	1	4	白(WH)
J2	2	4	绿(GN)
J3	3	4	黄(YE)
J4	4	4	灰(GY)
J5	6	4	粉(PK)
J6	8	4	红(RD)

规格

型号 订货号

每分口1路信号  
不带LED显示灯  
垂直式M12根线连接器  
主缆适配插件:  
EK8-\*M/P00

JB6M8-3-M12  
10072104

每分口1路信号  
带PNP LED显示灯  
垂直式M12根线连接器  
主缆适配插件:  
EK8-\*M/P00

JB6M8-3P-M12  
10072102

\* 标准长度为2/5/10米,可订制任意长度

\*\* 标准锁紧螺母材质为黄铜镀镍

- 外壳材质:尼龙,黑色
- 锁紧螺母:黄铜镀镍
- 针托:TPU材质,黑色
- 触点:黄铜镀金
- 密封圈:FPM/FKM,防护等级:IP67
- 负载:10~30VDC,6A总电流强度,2A分口电流强度,LED 10mA
- 使用环境温度:-30...+80°C
- 可插拔寿命:最小100次



外形尺寸 接线图

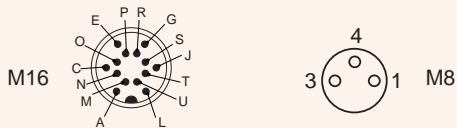
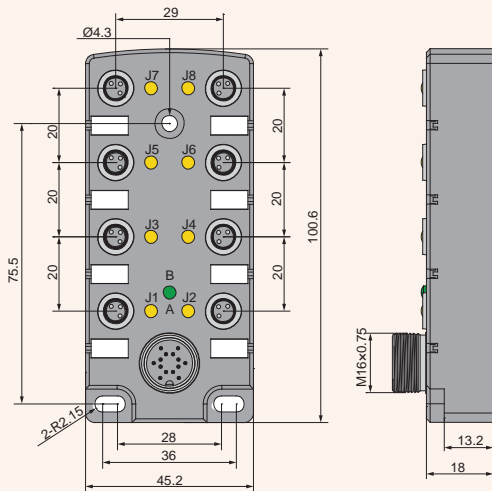

信号	M16 针脚号	M8 针脚号	适配电缆 线色
电源+	A/M	1	棕(BN)
电源-	L/U	3	蓝(BU)
J1	P	4	白(WH)
J2	J	4	绿(GN)
J3	T	4	黄(YE)
J4	S	4	灰(GY)
J5	G	4	粉(PK)
J6	R	4	红(RD)
J7	E	4	黑(BK)
J8	O	4	紫(VT)

规格

每分口1路信号  
不带LED显示灯  
垂直式M16根线连接器  
主线端适配插件:  
DNK14-10-\*M/P00

型号 订货号

JBW8M8-3-M16  
10073170

每分口1路信号  
带PNP LED显示灯  
垂直式M16根线连接器  
主线端适配插件:  
DNK14-10-\*M/P00

JBW8M8-3P-M16  
10073171

\* 标准长度为2/5/10米,可订制任意长度

\*\* 标准锁紧螺母材质为黄铜镀镍

# 宽型M8十二分口分线盒

- 外壳材质: 尼龙, 黑色
- 锁紧螺母: 黄铜镀镍
- 针托: TPU材质, 黑色
- 触点: 黄铜镀金
- 密封圈: FPM/FKM, 防护等级: IP67
- 负载: 10~30VDC, 6A总电流强度, 2A分口电流强度, LED 10mA
- 使用环境温度: -30...+80°C
- 可插拔寿命: 最小100次



外形尺寸 接线图

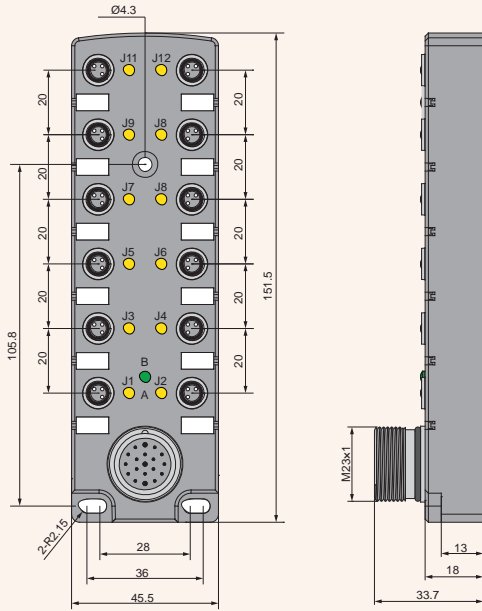

M23  
19-Pin

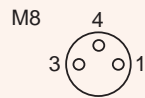
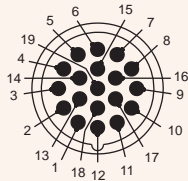

信号	M23 针脚号	M8 针脚号	适配电 缆线 色
电源+	19	1	棕(BN)
电源-	6	3	蓝(BU)
J1	1	4	白(WH)
J2	2	4	绿(GN)
J3	3	4	黄(YE)
J4	4	4	灰(GY)
J5	5	4	粉(PK)
J6	7	4	红(RD)
J7	8	4	黑(BK)
J8	9	4	紫(VT)
J9	10	4	灰粉(GY/PK)
J10	11	4	红蓝(RD/BU)
J11	13	4	白绿(WH/GN)
J12	14	4	棕绿(BN/GN)

规格

型号 订货号

每分口1路信号  
不带LED显示灯  
垂直式M23跟线连接器  
主线端适配插件:  
GNK19-14-\*M/P00

JBW12M8-3-T  
10073190

每分口1路信号  
带PNP LED显示灯  
垂直式M23跟线连接器  
主线端适配插件:  
GNK19-14-\*M/P00

JBW12M8-3P-T  
10074201

\* 标准长度为2/5/10米,可订制任意长度

\*\* 标准锁紧螺母材质为黄铜镀镍

- 外壳材质:尼龙,黑色
- 锁紧螺母:黄铜镀镍
- 针托:TPU材质,黑色
- 触点:黄铜镀金
- 密封圈:FPM/FKM,防护等级:IP67
- 负载:10~30VDC,9A总电流强度,2A分口电流强度,LED 10mA
- 使用环境温度:-30...+80°C
- 可插拔寿命:最小100次



外形尺寸 接线图		规格	型号 订货号
	每分口1路信号 不带LED显示灯 水平式M23根线连接器 主线端适配插件: GNK12-7-*M/P00	JB4M12-4 10071000	
	每分口1路信号 带PNP LED显示灯 水平式M23根线连接器 主线端适配插件: GNK12-7-*M/P00	JB4M12-4P 10071001	
	每分口1路信号 带NPN LED显示灯 水平式M23根线连接器 主线端适配插件: GNK12-7-*M/P00	JB4M12-4N 10071002	
	每分口1路信号 不带LED显示灯 垂直式M23根线连接器 主线端适配插件: GNK12-7-*M/P00	JB4M12-4-T 10071030	
	每分口1路信号 带PNP LED显示灯 垂直式M23根线连接器 主线端适配插件: GNK12-7-*M/P00	JB4M12-4P-T 10071031	
	每分口1路信号 带NPN LED显示灯 垂直式M23根线连接器 主线端适配插件: GNK12-7-*M/P00	JB4M12-4N-T 10071032	

信号	M23 针脚号	M12 针脚号	适配电缆 线色
电源+	11	1	棕(BN)
电源-	9+10	3	蓝(BU)
J1	1	4	白(WH)
J2	2	4	绿(GN)
J3	3	4	黄(YE)
J4	4	4	灰(GY)
PE	12	5	黄绿(GN/YE)

\* 标准长度为2/5/10米,可订制任意长度

\*\* 标准锁紧螺母材质为黄铜镀镍

# M12四分口分线盒

- 外壳材质:尼龙,黑色
- 锁紧螺母:黄铜镀镍
- 针托:TPU材质,黑色
- 触点:黄铜镀金
- 密封圈:FPM/FKM,防护等级:IP67
- 负载:10~30VDC,9A总电流强度,2A分口电流强度,LED 10mA
- 使用环境温度:-30...+80°C
- 可插拔寿命:最小100次



外形尺寸 接线图

规格

型号 订货号

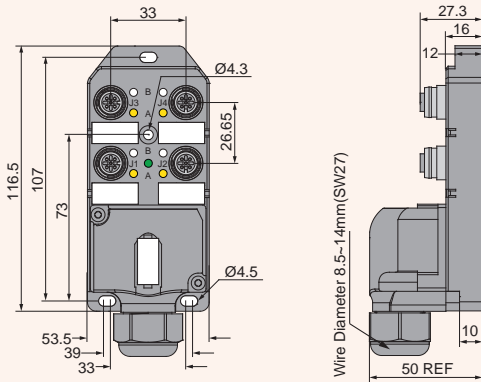

接线盒  
21-Pin

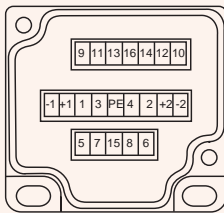

M12

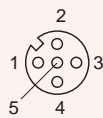

每分口1路信号  
不带LED显示灯  
接线盒式  
可适配电缆型号:  
58030151-\*M

JB4M12-4-J  
10071020

每分口1路信号  
带PNP LED显示灯  
接线盒式  
可适配电缆型号:  
58030151-\*M

JB4M12-4P-J  
10071021

每分口1路信号  
带NPN LED显示灯  
接线盒式  
可适配电缆型号:  
58030151-\*M

JB4M12-4N-J  
10071022

信号	接线盒 针脚号	M12 针脚号	适配电缆 线色
电源+	+2	1	棕(BN)
电源-	-2	3	蓝(BU)
J1	1	4	白(WH)
J2	2	4	绿(GN)
J3	3	4	黄(YE)
J4	4	4	灰(GY)
PE	PE	5	黄绿(GN/YE)

\* 标准长度为2/5/10米,可定制任意长度

\*\* 标准锁紧螺母材质为黄铜镀镍

- 外壳材质:尼龙,黑色
- 锁紧螺母:黄铜镀镍
- 针托:TPU材质,黑色
- 触点:黄铜镀金
- 密封圈:FPM/FKM,防护等级:IP67
- 负载:10~30VDC,9A总电流强度,2A分口电流强度,LED 10mA
- 使用环境温度:-30...+80°C
- 可插拔寿命:最小100次



外形尺寸 接线图

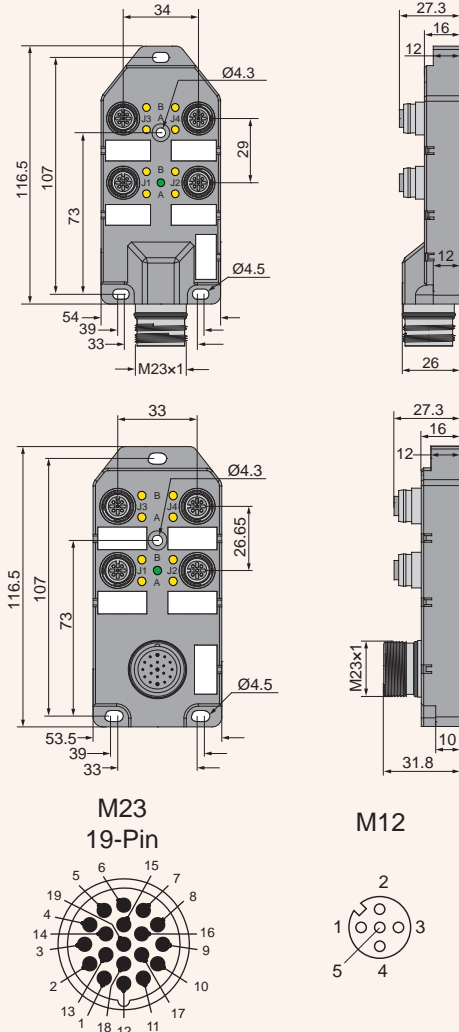

信号	M23 针脚号	M12 针脚号	适配电缆 线色
电源+	19	1	棕(BN)
电源-	6	3	蓝(BU)
J1	7	2	灰粉(GY/PK)
J1	15	4	白(WH)
J2	4	2	红蓝(RD/BU)
J2	5	4	绿(GN)
J3	8	2	白绿(WH/GN)
J3	16	4	黄(YE)
J4	14	2	棕绿(BN/GN)
J4	3	4	灰(GY)
PE	12	5	黄绿(GN/YE)

规格

型号 订货号

每分口2路信号  
不带LED显示灯  
水平式M23根线连接器  
主线端适配插件:  
GNK19-11-\*M/P00

JB4M12-4-R  
10071050

每分口2路信号  
带PNP LED显示灯  
水平式M23根线连接器  
主线端适配插件:  
GNK19-11-\*M/P00

JB4M12-4P-R  
10071051

每分口2路信号  
带NPN LED显示灯  
水平式M23根线连接器  
主线端适配插件:  
GNK19-11-\*M/P00

JB4M12-4N-R  
10071052

每分口2路信号  
不带LED显示灯  
M23垂直式根线连接器  
主线端适配插件:  
GNK19-11-\*M/P00

JB4M12-4-T-R  
10071080

每分口2路信号  
带PNP LED显示灯  
M23垂直式根线连接器  
主线端适配插件:  
GNK19-11-\*M/P00

JB4M12-4P-T-R  
10071081

每分口2路信号  
带NPN LED显示灯  
M23垂直式根线连接器  
主线端适配插件:  
GNK19-11-\*M/P00

JB4M12-4N-T-R  
10071082

\* 标准长度为2/5/10米,可订制任意长度

\*\* 标准锁紧螺母材质为黄铜镀镍

# M12四分口分线盒

- 外壳材质:尼龙,黑色
- 锁紧螺母:黄铜镀镍
- 针托:TPU材质,黑色
- 触点:黄铜镀金
- 密封圈:FPM/FKM,防护等级:IP67
- 负载:10~30VDC,9A总电流强度,2A分口电流强度,LED 10mA
- 使用环境温度:-30...+80°C
- 可插拔寿命:最小100次



外形尺寸 接线图

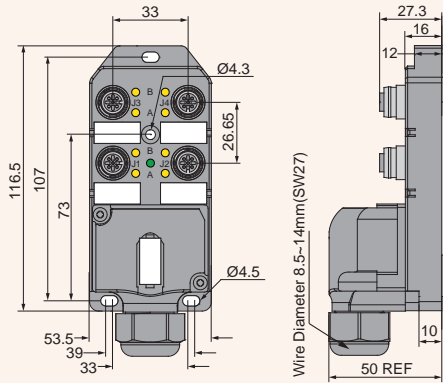

接线盒  
21-Pin

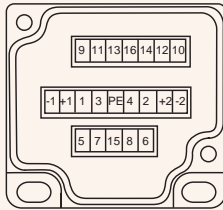

M12

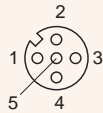

信号	接线盒 针脚号	M12 针脚号	适配电缆 线色
电源+	+1/+2	1	棕(BN)
电源-	-1/-2	3	蓝(BU)
J1	9	2	灰粉(GY/PK)
J1	1	4	白(WH)
J2	10	2	红蓝(RD/BU)
J2	2	4	绿(GN)
J3	11	2	白绿(WH/GN)
J3	3	4	黄(YE)
J4	12	2	棕绿(BN/GN)
J4	4	4	灰(GY)
PE	PE	5	黄绿(GN/YE)

规格

型号 订货号

每分口2路信号  
不带LED显示灯  
接线盒式  
主线端适配电缆:  
58096913-\*M

JB4M12-4-J-R  
10071070

每分口2路信号  
带PNP LED显示灯  
接线盒式  
主线端适配电缆:  
58096913-\*M

JB4M12-4P-J-R  
10071071

每分口2路信号  
带NPN LED显示灯  
接线盒式  
主线端适配电缆:  
58096913-\*M

JB4M12-4N-J-R  
10071072

\* 标准长度为2/5/10米,可订制任意长度

\*\* 标准锁紧螺母材质为黄铜镀镍

- 外壳材质:尼龙,黑色
- 锁紧螺母:黄铜镀镍
- 针托:TPU材质,黑色
- 触点:黄铜镀金
- 密封圈:FPM/FKM,防护等级:IP67
- 负载:10~30VDC,9A总电流强度,2A分口电流强度,LED 10mA
- 使用环境温度:-30...+80°C
- 可插拔寿命:最小100次



外形尺寸 接线图

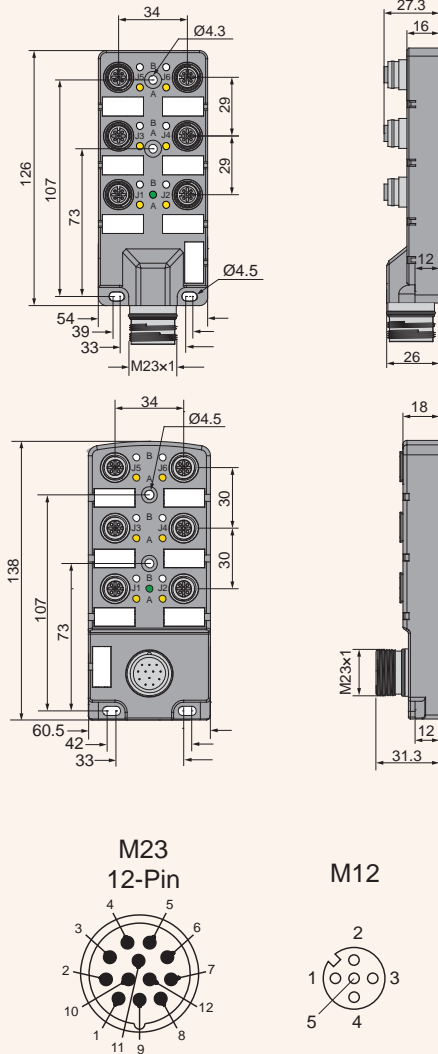

信号	M23 针脚号	M12 针脚号	适配电缆线色
电源+	11	1	棕(BN)
电源-	9+10	3	蓝(BU)
J1	1	4	白(WH)
J2	2	4	绿(GN)
J3	3	4	黄(YE)
J4	4	4	灰(GY)
J5	5	4	粉(PK)
J6	6	4	红(RD)
PE	12	5	黄绿(GN/YE)

规格

型号 订货号

每分口1路信号  
不带LED显示灯  
水平式M23根线连接器  
主线端适配插件:  
GNK12-9-\*M/P00

JB6M12-4  
10072000

每分口1路信号  
带PNP LED显示灯  
水平式M23根线连接器  
主线端适配插件:  
GNK12-9-\*M/P00

JB6M12-4P  
10072001

每分口1路信号  
带NPN LED显示灯  
水平式M23根线连接器  
主线端适配插件:  
GNK12-9-\*M/P00

JB6M12-4N  
10072002

每分口1路信号  
不带LED显示灯  
垂直式M23根线连接器  
主线端适配插件:  
GNK12-9-\*M/P00

JB6M12-4-T  
10072030

每分口1路信号  
带PNP LED显示灯  
垂直式M23根线连接器  
主线端适配插件:  
GNK12-9-\*M/P00

JB6M12-4P-T  
10072031

每分口1路信号  
带NPN LED显示灯  
垂直式M23根线连接器  
主线端适配插件:  
GNK12-9-\*M/P00

JB6M12-4N-T  
10072032

\* 标准长度为2/5/10米,可订制任意长度

\*\* 标准锁紧螺母材质为黄铜镀镍

# M12六分口分线盒

- 外壳材质:尼龙,黑色
- 锁紧螺母:黄铜镀镍
- 针托:TPU材质,黑色
- 触点:黄铜镀金
- 密封圈:FPM/FKM,防护等级:IP67
- 负载:10~30VDC,9A总电流强度,2A分口电流强度,LED 10mA
- 使用环境温度:-30...+80°C
- 可插拔寿命:最小100次



外形尺寸 接线图

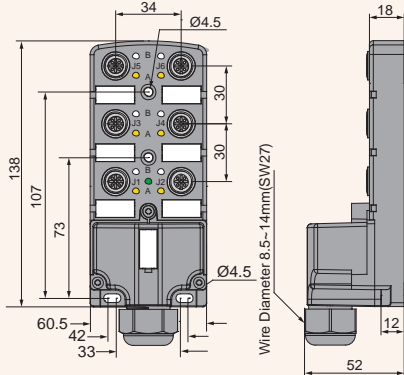

接线盒  
21-Pin

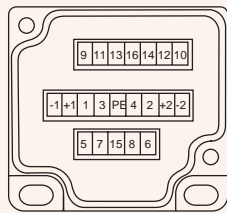

M12

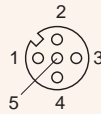

信号	M23 针脚号	M12 针脚号	适配电缆 线色
电源+	+1/+2	1	棕(BN)
电源-	-1/-2	3	蓝(BU)
J1	1	4	白(WH)
J2	2	4	绿(GN)
J3	3	4	黄(YE)
J4	4	4	灰(GY)
J5	5	4	粉(PK)
J6	6	4	红(RD)
PE	PE	5	黄绿(GN/YE)

规格

型号 订货号

每分口1路信号  
不带LED显示灯  
接线盒式  
主线端适配电缆:  
58031151-\*M

JB6M12-4-J  
10072020

每分口1路信号  
带PNP LED显示灯  
接线盒式  
主线端适配电缆:  
58031151-\*M

JB6M12-4P-J  
10072021

每分口1路信号  
带NPN LED显示灯  
接线盒式  
主线端适配电缆:  
58031151-\*M

JB6M12-4N-J  
10072022

\* 标准长度为2/5/10米,可订制任意长度

\*\* 标准锁紧螺母材质为黄铜镀镍

- 外壳材质:尼龙,黑色
- 锁紧螺母:黄铜镀镍
- 针托:TPU材质,黑色
- 触点:黄铜镀金
- 密封圈:FPM/FKM,防护等级:IP67
- 负载:10~30VDC,9A总电流强度,2A分口电流强度,LED 10mA
- 使用环境温度:-30...+80°C
- 可插拔寿命:最小100次



外形尺寸 接线图

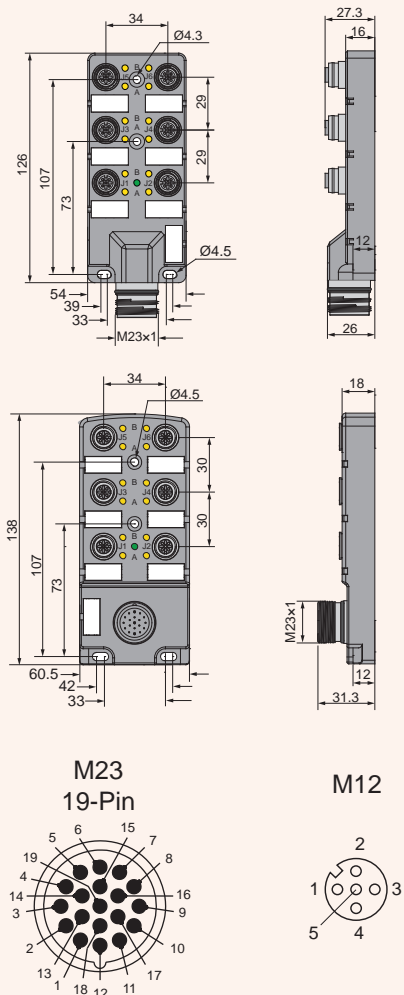

信号	M23 针脚号	M12 针脚号	适配电缆 线色
电源+	19	1	棕(BN)
电源-	6	3	蓝(BU)
J1	7	2	灰粉(GY/PK)
J1	15	4	白(WH)
J2	4	2	红蓝(RD/BU)
J2	5	4	绿(GN)
J3	8	2	白绿(WH/GN)
J3	16	4	黄(YE)
J4	14	2	棕绿(BN/GN)
J4	3	4	灰(GY)
J5	9	2	白黄(WH/YE)
J5	17	4	粉(PK)
J6	13	2	黄棕(YE/BN)
J6	2	4	红(RD)
PE	12	5	黄绿(GN/YE)

规格

型号 订货号

每分口2路信号  
不带LED显示灯  
水平式M23根线连接器  
主线端适配插件:  
GNK19-15-\*M/P00

JB6M12-4-R  
10071100

每分口2路信号  
带PNP LED显示灯  
水平式M23根线连接器  
主线端适配插件:  
GNK19-15-\*M/P00

JB6M12-4P-R  
10071101

每分口2路信号  
带NPN LED显示灯  
水平式M23根线连接器  
主线端适配插件:  
GNK19-15-\*M/P00

JB6M12-4N-R  
10071102

每分口2路信号  
不带LED显示灯  
垂直式M23根线连接器  
主线端适配插件:  
GNK19-15-\*M/P00

JB6M12-4-T-R  
10072080

每分口2路信号  
带PNP LED显示灯  
垂直式M23根线连接器  
主线端适配插件:  
GNK19-15-\*M/P00

JB6M12-4P-T-R  
10072081

每分口2路信号  
带NPN LED显示灯  
垂直式M23根线连接器  
主线端适配插件:  
GNK19-15-\*M/P00

JB6M12-4N-T-R  
10072082

\* 标准长度为2/5/10米,可订制任意长度

\*\* 标准锁紧螺母材质为黄铜镀镍

# M12六分口分线盒

- 外壳材质: 尼龙, 黑色
- 锁紧螺母: 黄铜镀镍
- 针托: TPU材质, 黑色
- 触点: 黄铜镀金
- 密封圈: FPM/FKM, 防护等级: IP67
- 负载: 10~30VDC, 9A总电流强度, 2A分口电流强度, LED 10mA
- 使用环境温度: -30...+80°C
- 可插拔寿命: 最小100次



外形尺寸 接线图

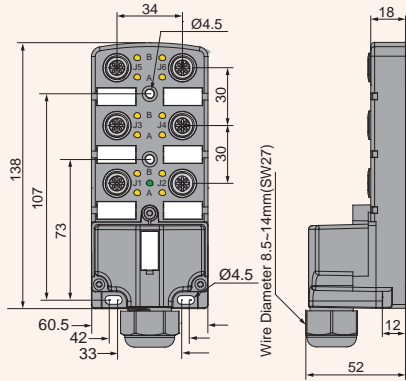

接线盒  
21-Pin

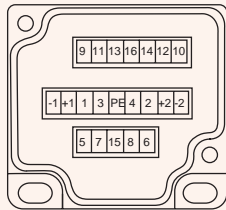

M12

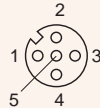

信号	接线盒 针脚号	M12 针脚号	适配电缆 线色
电源+	+1/+2	1	棕(BN)
电源-	-1/-2	3	蓝(BU)
J1	9	2	灰粉(GY/PK)
J1	1	4	白(WH)
J2	10	2	红蓝(RD/BU)
J2	2	4	绿(GN)
J3	11	2	白绿(WH/GN)
J3	3	4	黄(YE)
J4	12	2	棕绿(BN/GN)
J4	4	4	灰(GY)
J5	13	2	白黄(WH/YE)
J5	5	4	粉(PK)
J6	14	2	黄棕(YE/BN)
J6	6	4	红(RD)
PE	PE	5	黄绿(GN/YE)

规格

型号 订货号

每分口2路信号  
不带LED显示灯  
接线盒式  
主线端适配电缆:  
58028151-\*M

JB6M12-4-J-R  
10072070

每分口2路信号  
带PNP LED显示灯  
接线盒式  
主线端适配电缆:  
58028151-\*M

JB6M12-4P-J-R  
10072071

每分口2路信号  
带NPN LED显示灯  
接线盒式  
主线端适配电缆:  
58028151-\*M

JB6M12-4N-J-R  
10072072

\* 标准长度为2/5/10米,可订制任意长度

\*\* 标准锁紧螺母材质为黄铜镀镍

- 外壳材质:尼龙,黑色
- 锁紧螺母:黄铜镀镍
- 针托:TPU材质,黑色
- 触点:黄铜镀金
- 密封圈:FPM/FKM,防护等级:IP67
- 负载:10~30VDC,9A总电流强度,2A分口电流强度,LED 10mA
- 使用环境温度:-30...+80°C
- 可插拔寿命:最小100次



外形尺寸 接线图	规格	型号 订货号
	每分口1路信号 不带LED显示灯 水平式M23根线连接器 主线端适配插件: GNK12-11-*M/P00	JB8M12-4 10073000
	每分口1路信号 带PNP LED显示灯 水平式M23根线连接器 主线端适配插件: GNK12-11-*M/P00	JB8M12-4P 10073001
	每分口1路信号 带NPN LED显示灯 水平式M23根线连接器 主线端适配插件: GNK12-11-*M/P00	JB8M12-4N 10073002
	每分口1路信号 不带LED显示灯 垂直式M23根线连接器 主线端适配插件: GNK12-11-*M/P00	JB8M12-4-T 10073030
	每分口1路信号 带PNP LED显示灯 垂直式M23根线连接器 主线端适配插件: GNK12-11-*M/P00	JB8M12-4P-T 10073031
	每分口1路信号 带NPN LED显示灯 垂直式M23根线连接器 主线端适配插件: GNK12-11-*M/P00	JB8M12-4N-T 10073032

信号	M23 针脚号	M12 针脚号	适配电缆 线色
电源+	11	1	棕(BN)
电源-	9+10	3	蓝(BU)
J1	1	4	白(WH)
J2	2	4	绿(GN)
J3	3	4	黄(YE)
J4	4	4	灰(GY)
J5	5	4	粉(PK)
J6	6	4	红(RD)
J7	7	4	黑(BK)
J8	8	4	紫(VT)
PE	12	5	黄绿(GN/YE)

\* 标准长度为2/5/10米,可订制任意长度

\*\* 标准锁紧螺母材质为黄铜镀镍



- 外壳材质:尼龙,黑色
- 锁紧螺母:黄铜镀镍
- 针托:TPU材质,黑色
- 触点:黄铜镀金
- 密封圈:FPM/FKM,防护等级:IP67
- 负载:10~30VDC,9A总电流强度,2A分口电流强度,LED 10mA
- 使用环境温度:-30...+80°C
- 可插拔寿命:最小100次



外形尺寸 接线图

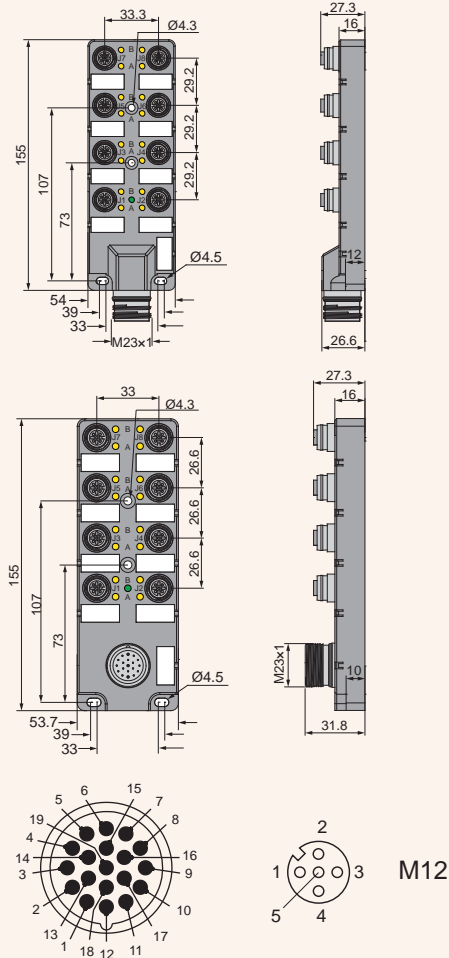

M23  
19-Pin

M12

信号	M23 针脚号	M12 针脚号	适配电缆 线色
电源+	19	1	棕(BN)
电源-	6	3	蓝(BU)
J1	7	2	灰粉(GY/PK)
J1	15	4	白(WH)
J2	4	2	红蓝(RD/BU)
J2	5	4	绿(GN)
J3	8	2	白绿(WH/GN)
J3	16	4	黄(YE)
J4	14	2	棕绿(BN/GN)
J4	3	4	灰(GY)
J5	9	2	白黄(WH/YE)
J5	17	4	粉(PK)
J6	13	2	黄棕(YE/BN)
J6	2	4	红(RD)
J7	10	2	白灰(WH/BK)
J7	11	4	黑(BK)
J8	18	2	灰棕(GY/BN)
J8	1	4	紫(VT)
PE	12	5	黄绿(GN/YE)

规格

型号 订货号

每分口2路信号  
不带LED显示灯  
水平式M23根线连接器  
主线端适配插件:  
GNK19-19-\*M/P00

JB8M12-4-R  
10073050

每分口2路信号  
带PNP LED显示灯  
水平式M23根线连接器  
主线端适配插件:  
GNK19-19-\*M/P00

JB8M12-4P-R  
10073051

每分口2路信号  
带NPN LED显示灯  
水平式M23根线连接器  
主线端适配插件:  
GNK19-19-\*M/P00

JB8M12-4N-R  
10073052

每分口2路信号  
不带LED显示灯  
垂直式M23根线连接器  
主线端适配插件:  
GNK19-19-\*M/P00

JB8M12-4-T-R  
10073080

每分口2路信号  
带PNP LED显示灯  
垂直式M23根线连接器  
主线端适配插件:  
GNK19-19-\*M/P00

JB8M12-4P-T-R  
10073081

每分口2路信号  
带NPN LED显示灯  
垂直式M23根线连接器  
主线端适配插件:  
GNK19-19-\*M/P00

JB8M12-4N-T-R  
10073082

\* 标准长度为2/5/10米,可订制任意长度

\*\* 标准锁紧螺母材质为黄铜镀镍

# M12八分口分线盒

- 外壳材质: 尼龙, 黑色
- 锁紧螺母: 黄铜镀镍
- 针托: TPU材质, 黑色
- 触点: 黄铜镀金
- 密封圈: FPM/FKM, 防护等级: IP67
- 负载: 10~30VDC, 9A总电流强度, 2A分口电流强度, LED 10mA
- 使用环境温度: -30...+80°C
- 可插拔寿命: 最小100次



外形尺寸 接线图

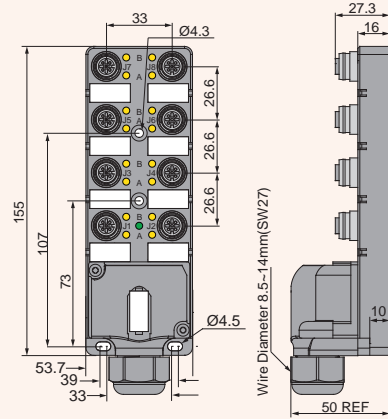

接线盒  
21-Pin

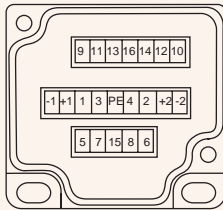

M12

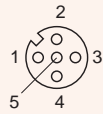

规格

型号 订货号

每分口2路信号  
不带LED显示灯  
接线盒式  
主线端适配电缆:  
58094911-\*M

JB8M12-4-J-R  
10073070

每分口2路信号  
带PNP LED显示灯  
接线盒式  
主线端适配电缆:  
58094911-\*M

JB8M12-4P-J-R  
10073071

每分口2路信号  
带NPN LED显示灯  
接线盒式  
主线端适配电缆:  
58094911-\*M

JB8M12-4N-J-R  
10073072

信号	接线盒 针脚号	M12 针脚号	适配电缆 线色
电源+	+1/+2	1	棕(BN)
电源-	-1/-2	3	蓝(BU)
J1	9	2	灰粉(GY/PK)
J1	1	4	白(WH)
J2	10	2	红蓝(RD/BU)
J2	2	4	绿(GN)
J3	11	2	白绿(WH/GN)
J3	3	4	黄(YE)
J4	12	2	棕绿(BN/GN)
J4	4	4	灰(GY)
J5	13	2	白黄(WH/YE)
J5	5	4	粉(PK)
J6	14	2	黄棕(YE/BN)
J6	6	4	红(RD)
J7	15	2	白灰(WH/BK)
J7	7	4	黑(BK)
J8	16	2	灰棕(GY/BN)
J8	8	4	紫(VT)
PE	PE	5	黄绿(GN/YE)

\* 标准长度为2/5/10米,可订制任意长度

\*\* 标准锁紧螺母材质为黄铜镀镍

## M12八分口PNP/NPN可调节型分线盒

- 外壳材质:尼龙,黑色
- 锁紧螺母:黄铜镀镍
- 针托:TPU材质,黑色
- 触点:黄铜镀金
- 密封圈:FPM/FKM,防护等级:IP67
- 负载:10~30VDC,9A总电流强度,2A分口电流强度,LED 10mA
- 使用环境温度:-30...+80°C
- 可插拔寿命:最小100次



外形尺寸 接线图

规格

型号 订货号

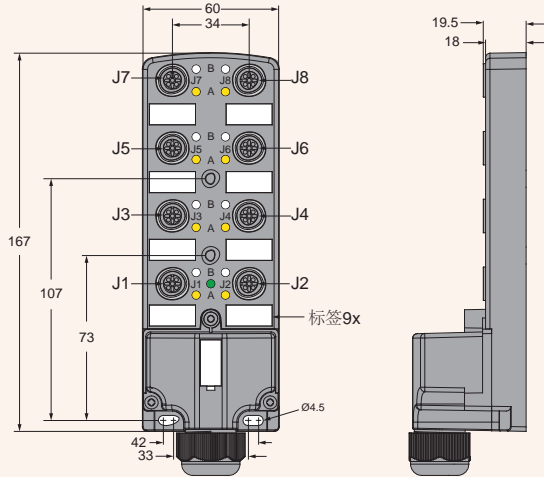

当开关在PNP位置时, 信号灯为黄色  
当开关在NPN位置时, 信号灯为蓝色

每分口1路信号  
PNP-NPN可转换型  
接线盒式  
主线端适配电缆:  
58092911-\*M

JB8M12-4PN-J  
10071138

接线盒  
21-Pin

M12

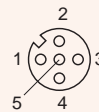
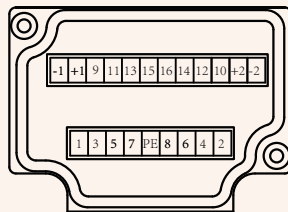

信号	接线盒 针脚号	M12 针脚号	适配电缆 线色
电源+	+2	1	棕(BN)
电源-	-2	3	蓝(BU)
J1	1	4	白(WH)
J2	2	4	绿(GN)
J3	3	4	黄(YE)
J4	4	4	灰(GY)
J5	5	4	粉(PK)
J6	6	4	红(RD)
J7	7	4	黑(BK)
J8	8	4	紫(VT)
PE	PE	5	黄绿(GN/YE)

\* 标准长度为2/5/10米,可订制任意长度

\*\* 标准锁紧螺母材质为黄铜镀镍

## M12八分口PNP/NPN可调节型分线盒

- 外壳材质:尼龙,黑色
- 锁紧螺母:黄铜镀镍
- 针托:TPU材质,黑色
- 触点:黄铜镀金
- 密封圈:FPM/FKM,防护等级:IP67
- 负载:10~30VDC,9A总电流强度,2A分口电流强度,LED 10mA
- 使用环境温度:-30...+80°C
- 可插拔寿命:最小100次



外形尺寸 接线图

规格

型号 订货号

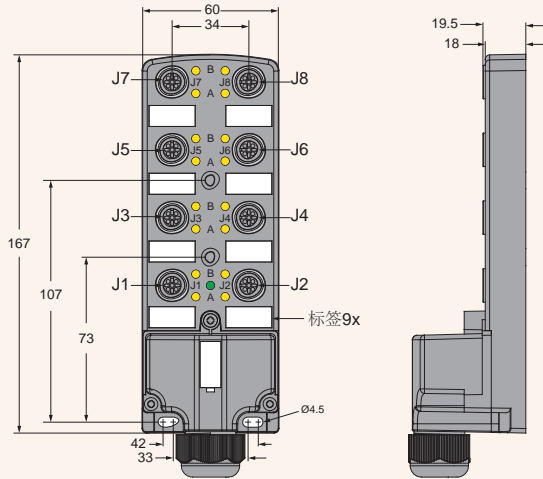

当开关在PNP位置时, 信号灯为黄色  
当开关在NPN位置时, 信号灯为蓝色

每分口2路信号  
PNP-NPN可转换型  
接线盒式  
主线端适配电缆:  
58094911-\*M

JB8M12-4PN-J-R  
10073077

接线盒  
21-Pin

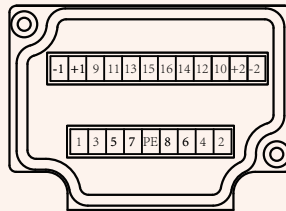

M12

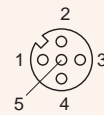

信号	接线盒 针脚号	M12 针脚号	适配电缆 线色
电源+	+1/+2	1	棕(BN)
电源-	-1/-2	3	蓝(BU)
J1	9	2	灰粉(GY/PK)
J1	1	4	白(WH)
J2	10	2	红蓝(RD/BU)
J2	2	4	绿(GN)
J3	11	2	白绿(WH/GN)
J3	3	4	黄(YE)
J4	12	2	棕绿(BN/GN)
J4	4	4	灰(GY)
J5	13	2	白黄(WH/YE)
J5	5	4	粉(PK)
J6	14	2	黄棕(YE/BN)
J6	6	4	红(RD)
J7	15	2	白灰(WH/BK)
J7	7	4	黑(BK)
J8	16	2	灰棕(GY/BN)
J8	8	4	紫(VT)
PE	PE	5	黄绿(GN/YE)

\* 标准长度为2/5/10米,可订制任意长度

\*\* 标准锁紧螺母材质为黄铜镀镍

## M12八分口电源分线盒

- 外壳材质:铸铝
- 锁紧螺母:黄铜镀镍
- 针托:TPU材质,黑色
- 触点:黄铜镀金
- 密封圈:FPM/FKM,防护等级:IP67
- 负载:10~30VDC,12A总电流强度,2A分口电流强度
- 使用环境温度:-25...+80°C
- 可插拔寿命:最小100次



外形尺寸 接线图

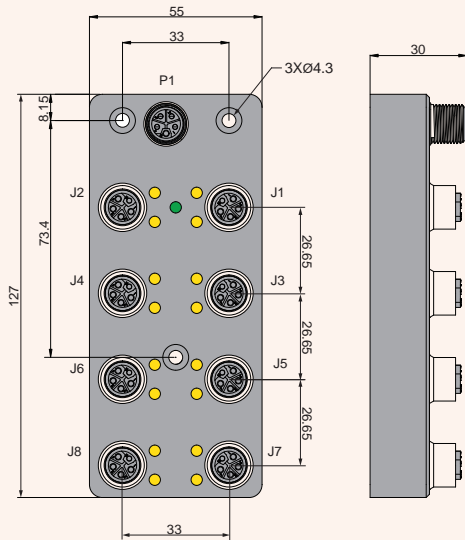

规格

J1~J8端:  
 每分口2路系统电源  
 2路负载电源  
 1路接地

垂直式P1端:  
 M12-L扣 线连接器  
 主线端适配插件:  
 PL-EK5-\*M/P00

型号 订货号

JBS8M12L-5  
 10076193

P1:  
 M12-L  
 5-Pin

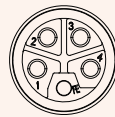
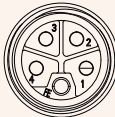

J1-J8:  
 M12-L  
 5-Pin

信号	P1端 M12-L扣 针脚号	J1~J8端 M12-L扣 针脚号
系统电源+	1	1
负载电源-	2	3
系统电源-	3	2
负载电源+	4	4
外壳	PE	PE

\* 标准长度为2/5/10米,可订制任意长度

\*\* 标准锁紧螺母材质为黄铜镀镍

## 7/8" 电源分线盒

- 4分口, 6分口, 8分口
- 铸铝外壳
- 7/8输入输出接口
- IP67防护等级



型号	订货号	特性
JBS4MK-4	10073177	4个7/8"分口,使用温度范围: -40°C ~ +75°C
		接线图
JBS6MK-4	10072023	6个7/8"分口,使用温度范围: -40°C ~ +75°C
		接线图
JBS8MK-4	10072024	8个7/8"分口,使用温度范围: -40°C ~ +75°C
		接线图

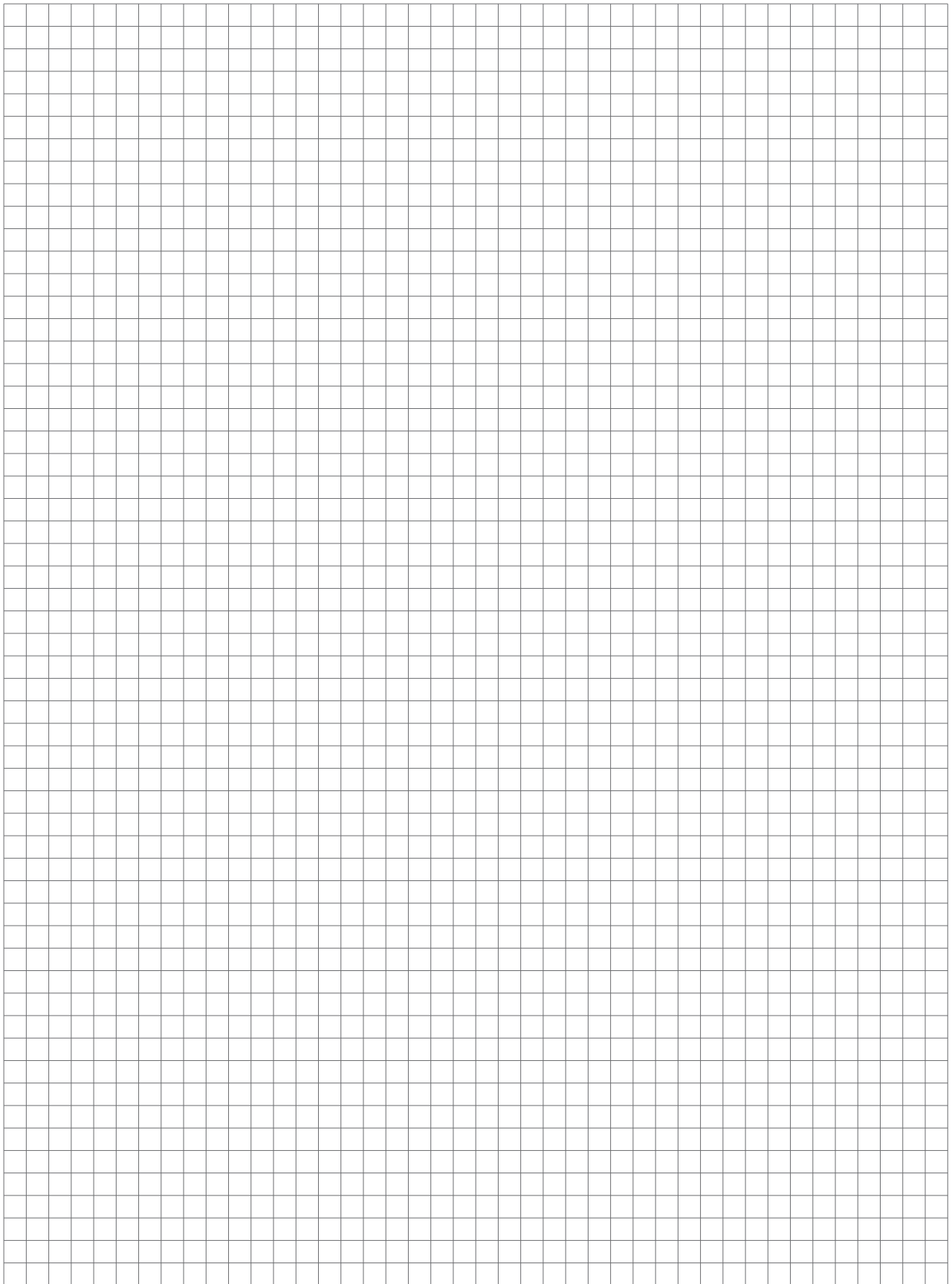





## ■ DeviceNet 协议通讯连接器

## 预铸电缆DeviceNet™连接器

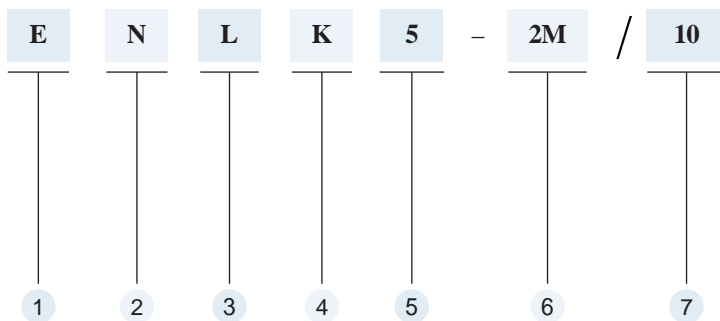

1 E M12x1连接器  
M 7/8" -16UN 连接器

2 N DeviceNet™型

3 L 直角型  
Blank 直线型

4 K 孔座  
Z 针座

5 针脚数  
编号分配  
1 Shield  
2 RD(V+)  
3 BK(V-)  
4 WH(CAN\_H)  
5 BU(CAN\_L)

6 线缆长度[m]

7 线缆材质代码\*\*  
Blank 粗缆 PVC  
0027 粗缆 TPE  
10 细缆 PVC  
0032 细缆 TPE

## 预铸法兰DeviceNet™连接器

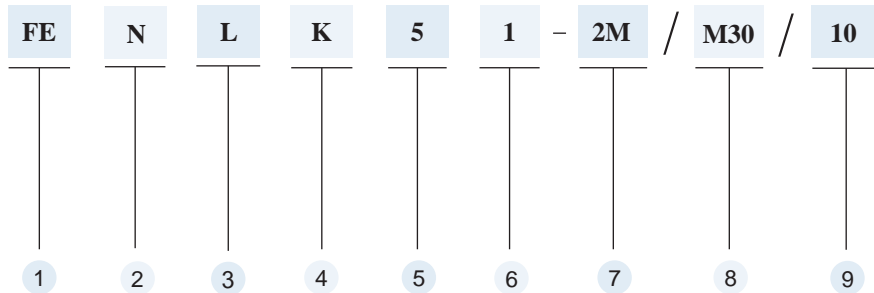

1 FE M12x1 预铸法兰连接器  
FM 7/8" -16UN 预铸法兰连接器

2 N DeviceNet™型

3 L 直角型  
Blank 直线型

4 K 孔座  
Z 针座

5 针脚数  
编号分配  
1 Shield  
2 RD(V+)  
3 BK(V-)  
4 WH(CAN\_H)  
5 BU(CAN\_L)

6 连接方式  
1 前端拧紧型  
2 后端拧紧型

7 线缆长度[m]

8 连接螺纹规格  
Blank PG9  
M30 M30X1.5  
NPSM 1/2-14NPSM

9 线缆材质代码  
G1 粗缆 PVC  
G2 细缆 PVC

DeviceNet™细缆

常用于DeviceNet™网络分支，用于干线时最大距离为100m

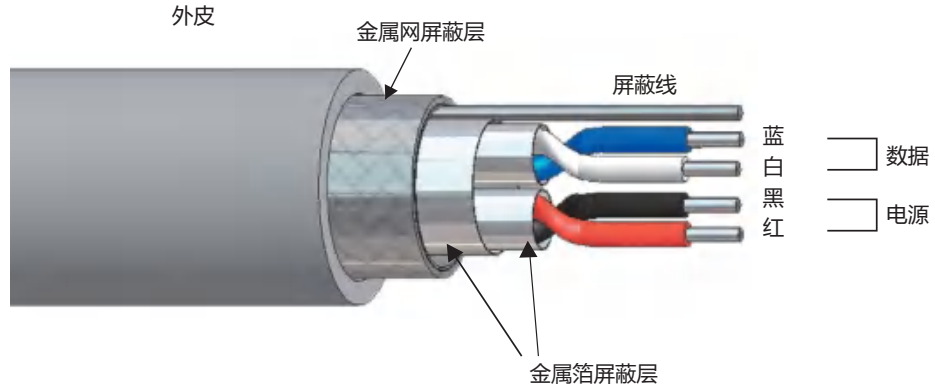

电缆型号	电源线		数据线		外皮	屏蔽类型	特性	后缀代码
	线规 颜色	每1000英寸的 直流电阻值颜色	AWG Color Code	DCR(/1000 feet) Insulation	材质、颜色 外径尺寸	屏蔽线 线规		
58221332-*M	2/22 AWG	18.1 Ohms	2/23 AWG	18.1 Ohms	PVC 灰色	金属箔		10 75°C 300 Volts
	BK/RD	PVC	BU/WH	PE	7.0 mm	24/22 AWG		
58214311-*M	2/22 AWG	16.5 Ohms	2/23 AWG	16.5 Ohms	TPE 木炭灰	金属箔/金属网	高柔 防焊溅	0032 80°C 600 Volts
	BK/RD	PVC	BU/WH	PE	8.5mm	24/22 AWG		
58007311-*M	2/24 AWG	24.9 Ohms	2/24 AWG	24.9 Ohms	PVC浅灰	金属箔		0024 80°C 300 Volts
	BK/RD	PVC	BU/WH	PE	5.7mm	24AWG		

DeviceNet™粗缆

用于DeviceNet™网络干线，最大距离为500m

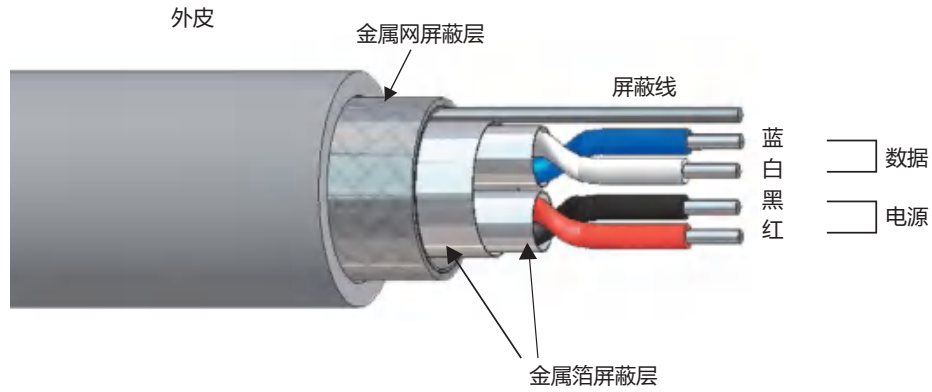

电缆型号	电源线		数据线		外皮 材质、颜色 外径尺寸	屏蔽类型 屏蔽线 线规	特性	后缀代码
	线规 颜色	每1000英寸的 直流电阻值颜色	AWG Color Code	DCR(/1000 feet) Insulation				
58200332-*M	2/15AWG	3.2 Ohms	2/18AWG	6.5 Ohms	PVC 灰色	金属箔/金属网		blank
	BK/RD	PVC	BU/WH	PE	12 mm	18 AWG		75°C 300 Volts
58312661-*M	2/15AWG	3.44 Ohms	2/18 AWG	7.06 Ohms	TPE 灰色	金属箔/金属网	高柔性	0027
	BK/RD	PE	BU/WH	PE	11.5 mm	18 AWG		75°C 300 Volts

- 预铸接头:TPU材质,蓝色
- 锁紧螺母:黄铜镀镍
- 针托:TPU材质,黑色
- 触点:黄铜镀金
- 密封圈:FPM/FKM
- 防护等级:IP67
- 电流等级:4A
- 电压等级:250V
- 绝缘电阻: $\geq 10^9 \Omega$
- 接触电阻: $\leq 5m\Omega$
- 污染等级:3
- 使用环境温度: $-40 \dots +75^\circ\text{C}$
- 可插拔寿命:最小100次



预铸式连接器	型号	订货号	引脚编号分布
直线孔座ENK..** 	ENK5-2M/10 ENK5-5M/10 ENK5-10M/10	10013000 10013015 10013018	孔座 
直角孔座ENLK..** 	ENLK5-2M/10 ENLK5-5M/10 ENLK5-10M/10	10013010 10013031 10012038	
直线针座ENZ..** 	ENZ5-2M/10 ENZ5-5M/10 ENZ5-10M/10	10013020 10013021 10016570	针座 
直角针座ENLZ..** 	ENLZ5-2M/10 ENLZ5-5M/10 ENLZ5-10M/10	10013030 10016571 10016572	
	ENK5 ENZ5-2M/10 ENK5 ENZ5-5M/10 ENK5 ENZ5-10M/10	10013404 10013046 10016573	
	ENLK5 ENZ5-2M/10 ENLK5 ENZ5-5M/10 ENLK5 ENZ5-10M/10	10013060 10016575 10016576	
	ENLK5 ENLZ5-2M/10 ENLK5 ENLZ5-5M/10 ENLK5 ENLZ5-10M/10	10013070 10012039 10013071	

\* 标准长度为2/5/10米,可订制任意长度

\*\* 标准锁紧螺母材质为黄铜镀镍

## 7/8" DeviceNet™粗缆预铸式连接器

- 预铸接头:TPU材质,蓝色
- 锁紧螺母:黄铜镀镍
- 针托:TPU材质,黑色
- 触点:黄铜镀金
- 防护等级:IP67
- 电流等级:9A
- 电压等级:600V
- 绝缘电阻: $\geq 10^9 \Omega$
- 接触电阻: $\leq 5m\Omega$
- 污染等级:3
- 使用环境温度: $-40 \dots +75^\circ\text{C}$
- 可插拔寿命:最小100次



预铸式连接器	型号	订货号	针脚编号分布
<b>直线孔座MNK..**</b> 	MNK5-2M MNK5-5M MNK5-10M	10031000 10031028 10031027	孔座 
<b>直角孔座MNLK..**</b> 	MNLK5-2M MNLK5-5M MNLK5-10M	10031010 10030662 10030663	
<b>直线针座MNZ..**</b> 	MNZ5-2M MNZ5-5M MNZ5-10M	10031020 10030605 10030602	针座 
<b>直角针座MNLZ..**</b> 	MNLZ5-2M MNLZ5-5M MNLZ5-10M	10031030 10030664 10030665	
	MNK5 MNZ5-2M MNK5 MNZ5-5M MNK5 MNZ5-10M	10031040 10031041 10031042	
	MNLK5 MNZ5-2M MNLK5 MNZ5-5M MNLK5 MNZ5-10M	10031060 10030669 10030671	
	MNLK5 MNLZ5-2M MNLK5 MNLZ5-5M MNLK5 MNLZ5-10M	10031070 10030672 10030673	

\* 标准长度为2/5/10米,可订制任意长度

\*\* 标准锁紧螺母材质为黄铜镀镍



法兰连接器	型号	订货号	特性描述	针脚编号分布
<p>7/8"后端锁紧,粗缆 孔座</p>	FMNK52-2M/NPSM/G1	10049403	<p>2x15 AWG, 2x18 AWG 18 AWG屏蔽线 铝箔屏蔽, 镀锡编织网 灰色PVC, Ø12mm 电缆型号: 58200332-*M -40°C ~ +80°C 600V 9A</p>	<p>孔座</p> <p>1.BARE(SHIELD) 2.RED(+VOLTAGE) 3.BLACK(-VOLTAGE) 4.WHITE(CAN_H) 5.BLUE(CAN_L)</p>
<p>7/8" 后端锁紧,粗缆 针座</p>	FMNZ52-2M/NPSM/G1	10049453		<p>针座</p> <p>1.BARE(SHIELD) 2.RED(+VOLTAGE) 3.BLACK(-VOLTAGE) 4.WHITE(CAN_H) 5.BLUE(CAN_L)</p>
<p>7/8"后端锁紧,细缆 孔座</p>	FMNK52-2M/NPSM/G2	10049413	<p>4x22 AWG 22AWG屏蔽线 铝箔屏蔽, 镀锡编织网 灰色PVC, Ø7.9mm 电缆型号: 58221332-*M -40°C ~ +80°C 300V 4A</p>	<p>孔座</p> <p>1.BARE(SHIELD) 2.RED(+VOLTAGE) 3.BLACK(-VOLTAGE) 4.WHITE(CAN_H) 5.BLUE(CAN_L)</p>
<p>7/8" 后端锁紧,细缆 针座</p>	FMNZ52-2M/NPSM/G2	10049463		<p>针座</p> <p>1.BARE(SHIELD) 2.RED(+VOLTAGE) 3.BLACK(-VOLTAGE) 4.WHITE(CAN_H) 5.BLUE(CAN_L)</p>

# 7/8" DeviceNet™法兰连接器



法兰连接器	型号	订货号	特性描述	针脚编号分布
<p>7/8"前端锁紧,粗缆 孔座</p>	FMNK51-2M/M30/G1	10093289	<p>2x15 AWG, 2x18 AWG 18 AWG屏蔽线 铝箔屏蔽, 镀锡编织网 灰色PVC, Ø12mm 电缆型号: 58200332-*M -40°C ~ +80°C 600V 9A</p>	<p>孔座</p> <p>1.BARE(SHIELD) 2.RED(+VOLTAGE) 3.BLACK(-VOLTAGE) 4.WHITE(CAN_H) 5.BLUE(CAN_L)</p>
<p>7/8" 前端锁紧,粗缆 针座</p>	FMNZ51-2M/M30/G1	10093290	<p>58200332-*M -40°C ~ +80°C 600V 9A</p>	<p>针座</p> <p>1.BARE(SHIELD) 2.RED(+VOLTAGE) 3.BLACK(-VOLTAGE) 4.WHITE(CAN_H) 5.BLUE(CAN_L)</p>
<p>7/8"前端锁紧,细缆 孔座</p>	FMNK51-2M/M30/G2	10093291	<p>4x22 AWG 22AWG屏蔽线 铝箔屏蔽, 镀锡编织网 灰色PVC, Ø7.9mm 电缆型号: 58221332-*M -40°C ~ +80°C 300V 4A</p>	<p>孔座</p> <p>1.BARE(SHIELD) 2.RED(+VOLTAGE) 3.BLACK(-VOLTAGE) 4.WHITE(CAN_H) 5.BLUE(CAN_L)</p>
<p>7/8" 前端锁紧,细缆 针座</p>	FMNZ51-2M/M30/G2	10093292	<p>58221332-*M -40°C ~ +80°C 300V 4A</p>	<p>针座</p> <p>1.BARE(SHIELD) 2.RED(+VOLTAGE) 3.BLACK(-VOLTAGE) 4.WHITE(CAN_H) 5.BLUE(CAN_L)</p>

- 预铸接头:TPU材质,蓝色
- 锁紧螺母:黄铜镀镍
- 针托:TPU材质,黑色
- 触点:黄铜镀金
- 密封圈:FPM/FKM
- 防护等级:IP67
- 绝缘电阻: $\geq 10^9 \Omega$
- 接触电阻: $\leq 5m\Omega$
- 污染等级:3
- 使用环境温度: $-40 \dots +75^\circ\text{C}$
- 可插拔寿命:最小100次



型号	特性
ENZ5-8YK5-ENK5-0024-LDC	TPU,250V,4A,-40°C ~ +75°C,分支数,长度,以及M12接头类型可根据客户的特殊需求定制

多分支结构，长度根据具体应用环境定制

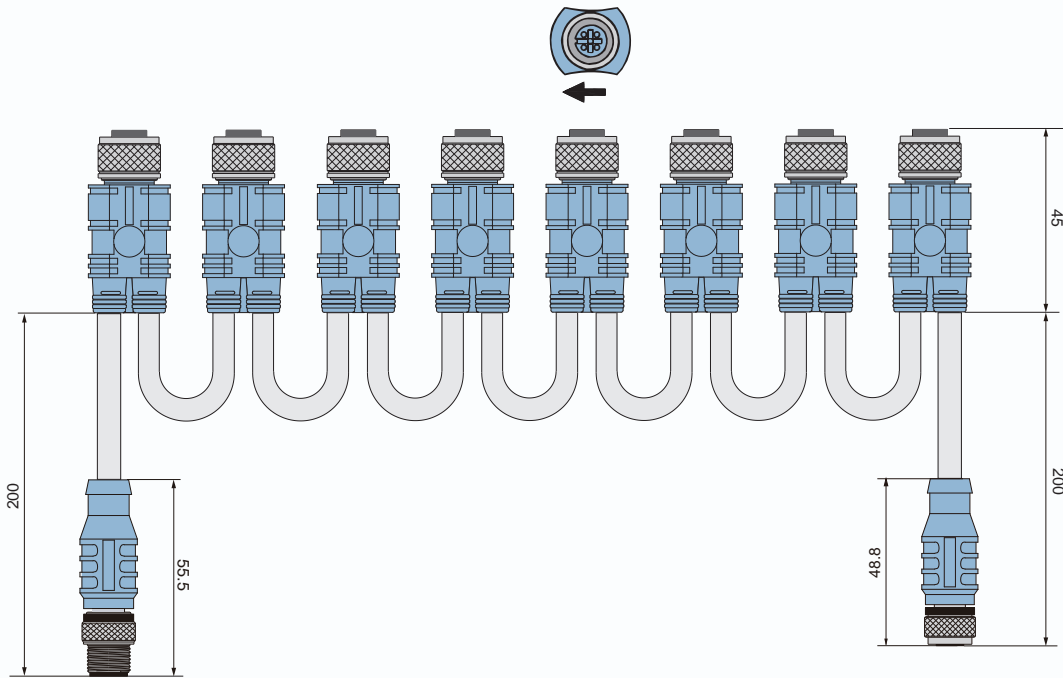

针脚分布

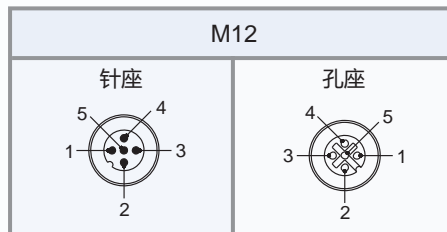

# 7/8" DeviceNet™分线盒

- 6分口, 8分口
- 尼龙加玻璃纤维外壳
- 7/8"/M12输入输出接口
- IP67防护等级

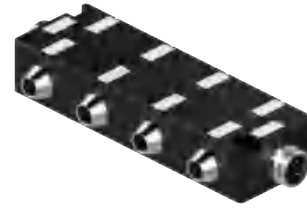

型号	订货号	特性
JB8MENK-DN/ES	10074501	4个7/8"分口,4个M12分口,使用温度范围: -40°C ~ +75°C
JB8ENK-DN	10074508	8个M12分口,使用温度范围: -40°C ~ +75°C
JB6ENK-DN	10074520	6个M12分口,使用温度范围: -40°C ~ +75°C

- 4分口, 6分口, 8分口
- 尼龙加玻璃纤维外壳
- 7/8输入输出接口
- IP67防护等级



型号	订货号	特性
JB6MNK-DN	10074504	6个7/8"分口,使用温度范围: -40°C ~ +75°C
		<p>接线图</p>
JB8MNK-DN	10074500	8个7/8"分口,使用温度范围: -40°C ~ +75°C
		<p>接线图</p>

# 7/8" DeviceNet™分线盒

- 8分口
- 尼龙加玻璃纤维
- 7/8输入输出接口
- IP67防护等级



型号	订货号	特性
JB8ENK-2DN-E811	10074511	8个M12分口,使用温度范围: -40°C ~ +75°C
<p>亮灯颜色含义: 红色: 过压, 蓝色: 欠压, 绿色: 正常</p>		<p>接线图</p>

- 4分口, 6分口, 8分口
- 铸铝外壳
- 7/8输入输出接口
- IP67防护等级



型号	订货号	特性
JBS4MNK-DN	10074509	4个7/8"分口,使用温度范围: -40°C ~ +75°C
		<p>接线图</p>
JBS6MNK-DN	10074510	6个7/8"分口,使用温度范围: -40°C ~ +75°C
		<p>接线图</p>
JBS8MNK-DN	10074505	8个7/8"分口,使用温度范围: -40°C ~ +75°C
		<p>接线图</p>

# 7/8" DeviceNet™分线盒



T型头及终端电阻	型号	订货号	针脚排列图
<b>DeviceNET T型头</b> 	MNZ5-2MKN5	10082000	<p>1=Shield 2=RD(V+) 3=BK(V-) 4=WH(CAN_H) 5=BU(CAN_L)</p>
<b>DeviceNET T型头</b> 	MNZ5-ENK5-MNK5	10082001	<p>1=Shield 2=RD(V+) 3=BK(V-) 4=WH(CAN_H) 5=BU(CAN_L)</p>
<b>DeviceNET 分线器</b> 	ENZ5-2ENK5-V	10082003	<p>1=Shield 2=RD(V+) 3=BK(V-) 4=WH(CAN_H) 5=BU(CAN_L)</p>
<b>终端电阻</b> M12x1针座 M12x1孔座 	ENZ5-TR ENK5-TR	10085010 10085011	<p>1=Shield 2=RD(V+) 3=BK(V-) 4=WH(CAN_H) 5=BU(CAN_L)</p>
<b>终端电阻</b> 7/8"针座 7/8"孔座 	MNZ5-TR MNK5-TR	10085020 10085021	<p>1=Shield 2=RD(V+) 3=BK(V-) 4=WH(CAN_H) 5=BU(CAN_L)</p>
<b>带灯终端电阻</b> 7/8"针座 7/8"孔座 	MNZ5-TR/VM MNK5-TR/VM	10085025 10031034	<p>1=Shield 2=RD(V+) 3=BK(V-) 4=WH(CAN_H) 5=BU(CAN_L)</p>

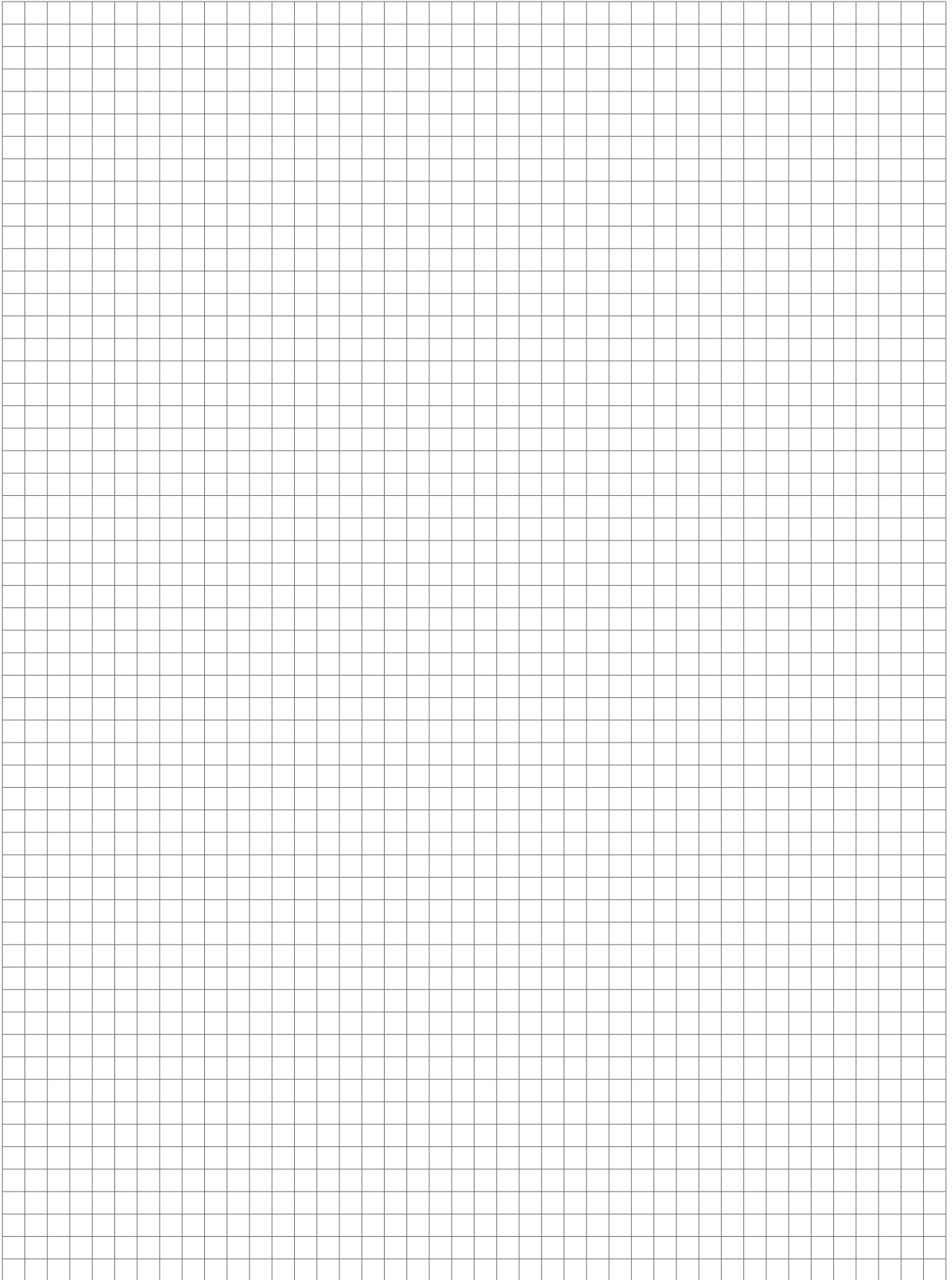





## ■ Profibus-DP 协议通讯连接器

# Profibus-DP总线连接器型号命名规则

## Profibus-DP总线 M12预铸连接器命名规则

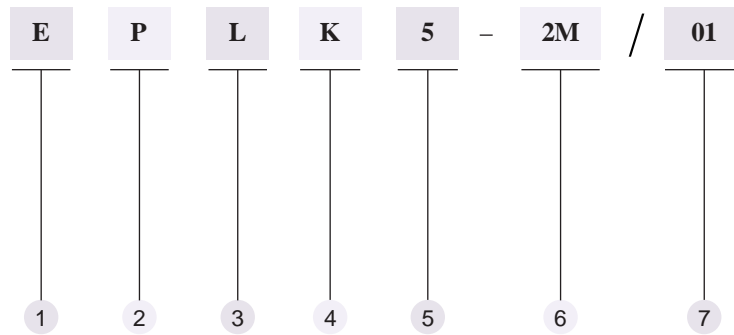

1 E M12x1连接器

2 P Profibus-DP型

3 Blank 直线型  
L 直角型

4 K 孔座  
Z 针座

5 针脚数  
编号分配  
1 N/C  
2 GN(Bus A)  
3 N.C  
4 RD(Bus B)  
5 Shield

6 线缆长度[m]

7 线缆材质代码  
Blank PVC固定安装  
01 PUR拖链安装

## Profibus-DP总线 M12预铸法兰连接器命名规则

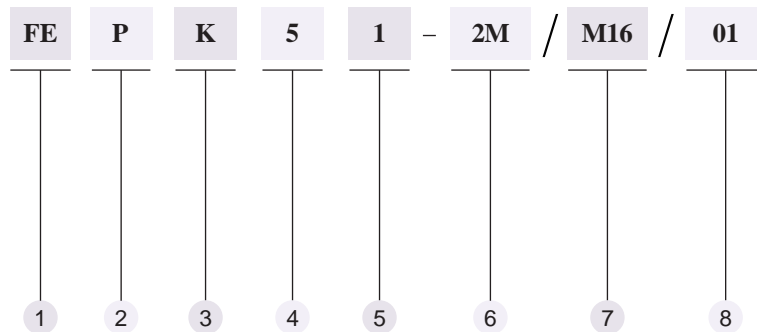

1 FE M12x1法兰连接器

2 P Profibus-DP型

3 K 孔座  
Z 针座

4 针脚数  
编号分配  
1 N/C  
2 GN(Bus A)  
3 N.C  
4 RD(Bus B)  
5 Shield

5 连接方式  
1 前端拧紧  
2 后端拧紧

6 线缆长度[m]

7 穿板位置尺寸  
Blank PG9  
M16 M16\*1.5

8 线缆材质代码  
Blank PVC固定安装电缆  
01 PUR拖链安装电缆

## M12 Profibus-DP预铸式连接器

- 预铸接座:TPU材质,黑色
- 锁紧螺母:黄铜镀镍
- 针托:TPU材质,黑色
- 触点:黄铜镀金
- 密封圈:FPM/FKM
- 电缆外皮:PVC紫色
- 绝缘线芯材质:PE
- 防护等级:IP67
- 电流等级:4A
- 电压等级:250V
- 绝缘电阻: $\geq 10^9 \Omega$
- 接触电阻: $\leq 5m\Omega$
- 污染等级:3
- 使用环境温度: $-40...+75^\circ\text{C}$
- 可插拔寿命:最小100次



连接器类型	型号	订货号	针脚编号分布
<b>直线孔座EPK..**</b> 	EPK5-2M EPK5-5M EPK5-10M	10012000 10012012 10012014	<p>孔座</p>
<b>直角孔座EPLK..**</b> 	EPLK5-2M EPLK5-5M EPLK5-10M	10012010 10012154 10012084	<p>1.N/C 2.GN(Bus A) 3.N/C 4.RD (Bus B) 5.Shield</p>
<b>直线针座EPZ..**</b> 	EPZ5-2M EPZ5-5M EPZ5-10M	10012020 10012025 10012026	<p>针座</p>
<b>直角针座EPLZ..**</b> 	EPLZ5-2M EPLZ5-5M EPLZ5-10M	10012030 10012155 10012533	<p>1.N/C 2.GN(Bus A) 3.N/C 4.RD (Bus B) 5.Shield</p>
	EPK5 EPZ5-2M EPK5 EPZ5-5M EPK5 EPZ5-10M	10012040 10012041 10012049	<p>孔座                      针座</p>
	EPK5 EPLZ5-2M EPK5 EPLZ5-5M EPK5 EPLZ5-10M	10012050 10012534 10012535	<p>1.N/C 2.GN(Bus A) 3.N/C 4.RD (Bus B) 5.Shield</p>
	EPLK5 EPZ5-2M EPLK5 EPZ5-5M EPLK5 EPZ5-10M	10012060 10012565 10012566	<p>孔座                      针座</p>
	EPLK5 EPLZ5-2M EPLK5 EPLZ5-5M EPLK5 EPLZ5-10M	10012070 10012100 10012107	<p>1.N/C 2.GN(Bus A) 3.N/C 4.RD (Bus B) 5.Shield</p>

\* 标准长度为2/5/10米,可订制任意长度

\*\* 标准锁紧螺母材质为黄铜镀镍

\*\*\*电缆型号CS022280-\*M

# M12 Profibus-DP预铸式连接器

- 预铸接头:TPU材质,黑色
- 锁紧螺母:黄铜镀镍
- 针托:TPU材质,黑色
- 触点:黄铜镀金
- 密封圈:FPM/FKM
- 电缆外皮:PUR紫色
- 绝缘线芯材质:PE
- 防护等级:IP67
- 电流等级:4A
- 电压等级:250V
- 绝缘电阻: $\geq 10^9 \Omega$
- 接触电阻: $\leq 5m\Omega$
- 污染等级:3
- 使用环境温度:-40...+75°C
- 可插拔寿命:最小100次



连接器类型	型号	货号	针脚编号分布
直线孔座EPK..** 	EPK5-2M/01 EPK5-5M/01 EPK5-10M/01	10012500 10012501 10012502	
直角孔座EPLK..** 	EPLK5-2M/01 EPLK5-5M/01 EPLK5-10M/01	10012510 10012536 10012537	
直线针座EPZ..** 	EPZ5-2M/01 EPZ5-5M/01 EPZ5-10M/01	10012520 10012023 10012522	
直角针座EPLZ..** 	EPLZ5-2M/01 EPLZ5-5M/01 EPLZ5-10M/01	10012530 10012538 10012539	
	EPK5 EPZ5-2M/01 EPK5 EPZ5-5M/01 EPK5 EPZ5-10M/01	10012540 10012541 10012542	孔座                      针座 
	EPK5 EPLZ5-2M/01 EPK5 EPLZ5-5M/01 EPK5 EPLZ5-10M/01	10012550 10012543 10012545	
	EPLK5 EPZ5-2M/01 EPLK5 EPZ5-5M/01 EPLK5 EPZ5-10M/01	10012560 10012563 10012546	孔座                      针座 
	EPLK5 EPLZ5-2M/01 EPLK5 EPLZ5-5M/01 EPLK5 EPLZ5-10M/01	10012570 10012548 10012077	

\* 标准长度为2/5/10米,可订制任意长度    \*\* 标准锁紧螺母材质为黄铜镀镍    \*\*\*电缆型号CS022281-\*M

## M12 Profibus-DP预铸式法兰连接器

- 预铸接座:TPU材质,黑色
- 锁紧螺母:黄铜镀镍
- 针托:TPU材质,黑色
- 触点:黄铜镀金
- 密封圈:FPM/FKM
- 电缆外皮:PVC紫色
- 绝缘线芯材质:PE
- 防护等级:IP67
- 电流等级:4A
- 电压等级:250V
- 绝缘电阻: $\geq 10^9 \Omega$
- 接触电阻: $\leq 5m\Omega$
- 污染等级:3
- 使用环境温度: $-40 \dots +75^\circ\text{C}$
- 可插拔寿命:最小100次



连接器类型	型号	订货号	针脚编号分布
<p>M12预铸法兰孔座</p>	<p>FEPK51-2M FEPK51-5M FEPK51-10M</p>	<p>10041529 10093315 10093316</p>	<p>孔座</p>
<p>M12预铸法兰针座</p>	<p>FEPZ51-2M FEPZ51-5M FEPZ51-10M</p>	<p>10093317 10093318 10093319</p>	<p>针座</p>

\* 标准长度为2/5/10米,可订制任意长度

\*\* 标准锁紧螺母材质为黄铜镀镍

# Profibus-DP附件



附件	型号	订货号	针脚排列图
<p>Profibus-DP T型头</p>	EPK5-2EPZ5-V	10081001	
<p>Profibus-DP 终端电阻</p>	EPZ5-TR	10085000	
<p>M12直线孔座</p>	EK5228-0/9	10091200	<p>孔座</p>
<p>M12直线针座</p>	EZ5228-0/9	10091210	
<p>M12直角孔座</p>	ELK5228-0/9	10091201	
<p>M12直角针座</p>	ELZ5228-0/9	10091211	

- D9T接头防护等级IP20
- M12接头防护等级IP67
- 与分线器配合双端预铸连接器的方案比较具有价格优势

型号	特性
D9T-EPK5-EPZ5-1.5M-1.5M/01	PUR,MAX250V,4A,静止状态-60 ~ +95°C,运动状态-25°C ~ +60°C, 电缆线规2x0.34mm <sup>2</sup> 电缆外皮材质: PUR,电缆绝缘材质: PE,屏蔽: 金属网,金属箔, 折弯半径: 5D(静止),10D(运动), 电缆长度,以及M12接头类型可根据客户的特殊需求定制

长度根据具体应用环境定制

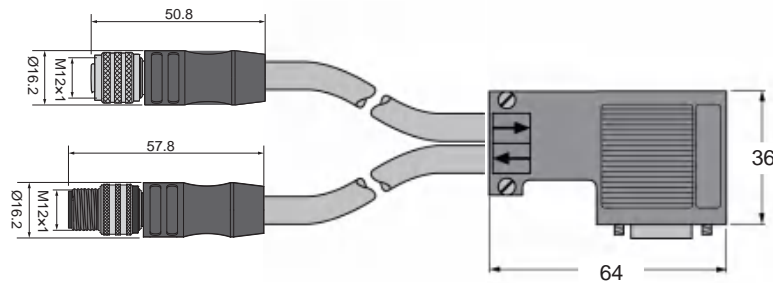

## 引脚分布

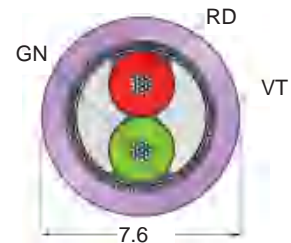
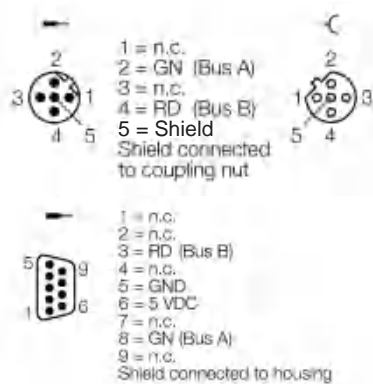

\* 标准长度为2/5/10米,可订制任意长度

\*\* 标准锁紧螺母材质为黄铜镀镍

Profibus-DP 线缆

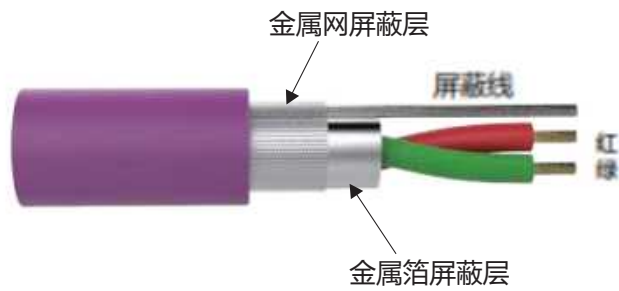

电缆型号	电源线	数据线		外皮	屏蔽类型	后缀代码	应用环境
	线规 颜色	AWG Color Code	DCR(/1000 feet) Insulation	材质、颜色 外径尺寸	屏蔽线 线规		
58019162-M	----	2/23 AWG RD/GN	21.4 Ohms PE	PVC 紫色 8.0 mm	金属箔/金属网 23 AWG	Blank 80°C 300 Volts	固定安装
58028161-M	----	2/23 AWG RD/GN	21.4 Ohms PE	TPU 紫色 8.0mm	金属箔/金属网 23 AWG	01 80°C 300 Volts	拖链安装≥500万

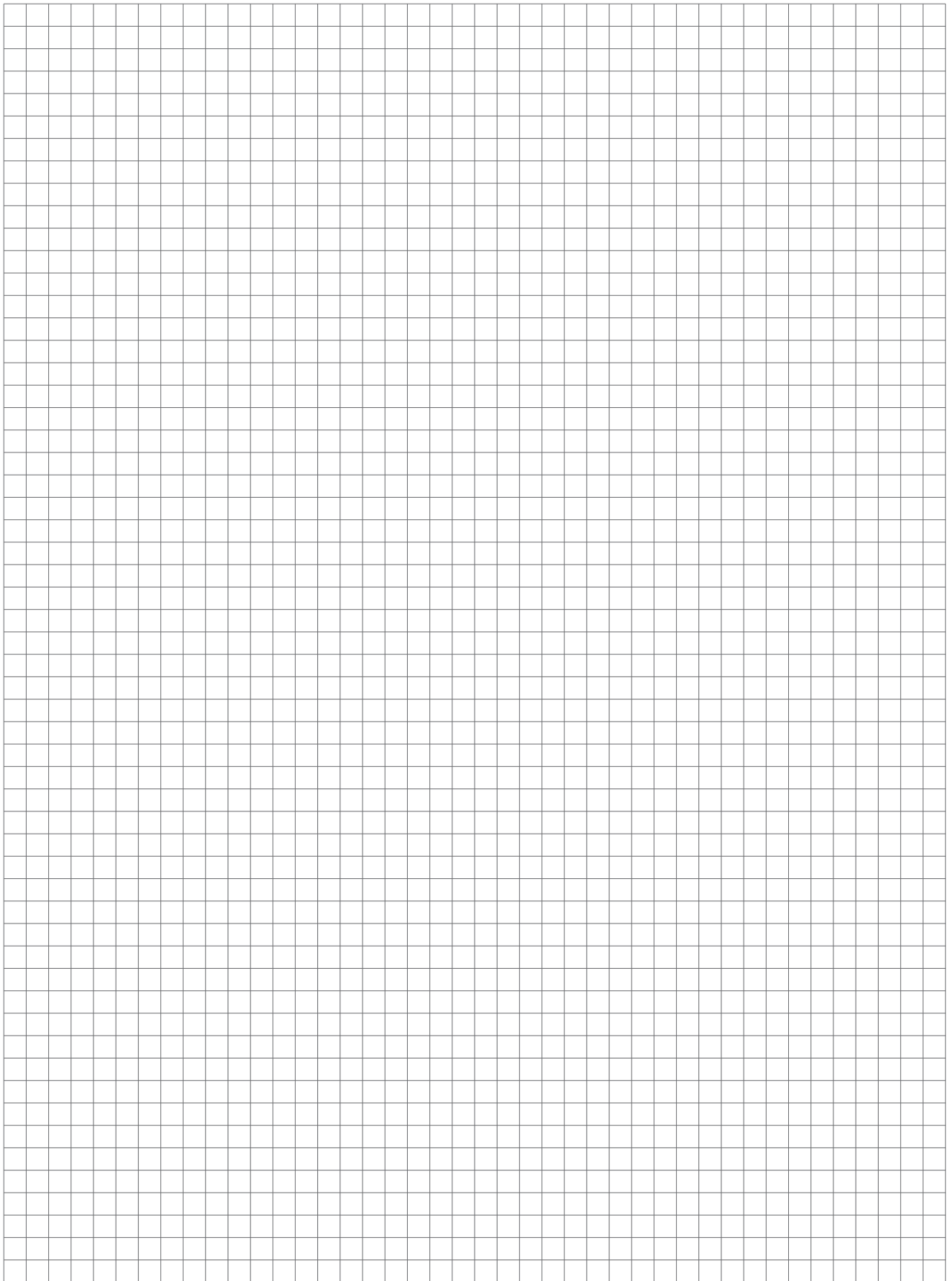





## ■ CC-Link 协议通讯连接器

## CC-Link 预铸式连接器

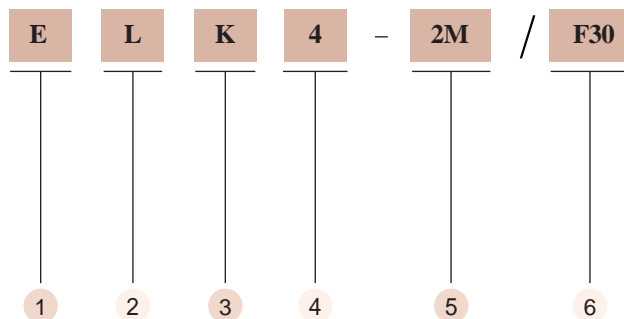

1 E M12x1 连接器  
M 7/8' 连接器

2 L 直角型  
Blank 直线型

3 K 孔座  
Z 针座

4 针脚数

5 线缆长度[m]

6 线缆材质代码  
F30 PVC 固定安装  
F31 PVC 拖链  
S30 PVC 固定安装

## 预铸法兰连接器

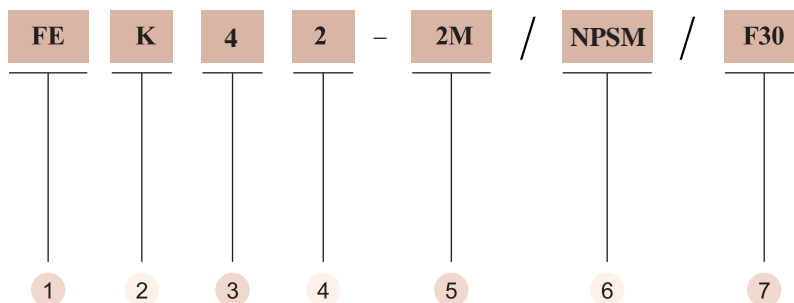

1 FE M12x1法兰连接器  
FM 7/8'-16UN法兰连接器

2 K 孔座  
Z 针座

3 针脚数  
编号分配

4 连接方式  
1 前端拧紧  
2 后端拧紧

5 线缆长度[m]

6 穿板位置尺寸  
M30 M30X1.5  
NPT 1/2-14NPT  
NPSM 1/2-14NPSM

7 线缆材质代码  
F30 PVC 固定安装  
F31 PVC 拖链  
S30 PVC 固定安装

## CC-Link 线缆



电缆型号	电源线	数据线		外皮	屏蔽类型	后缀代码	应用环境
	线规 颜色	AWG Color Code	DCR(/1000 feet) Insulation	材质、颜色 外径尺寸	屏蔽线 线规		
58569661-*M	----	3/20 AWG WH/YE/BU	11.4 Ohms PE	PVC 棕色 7.5 mm	金属箔/金属网 22 AWG	F30 75°C 300 Volts	固定安装
58687661-*M	----	3/20 AWG WH/YE/BU	11.4 Ohms PE	PVC 棕色 8.0mm	金属箔/金属网 22 AWG	F31 75°C 300 Volts	拖链安装≥500万
58501661-*M	2/19 AWG BK/WH	3/20 AWG WH/YE/BU	7.6 Ohms 11.4 Ohms PE	PVC 棕色 12 mm	金属箔/金属网 22 AWG	S30 75°C 300 Volts	固定安装

# M12 CC-Link 预铸式连接器

- 预铸接头:TPU材质,黑色
- 锁紧螺母:黄铜镀镍
- 针托:TPU材质,黑色
- 触点:黄铜镀金
- 密封圈:FPM/FKM
- 防护等级:IP67
- 电流等级:4A
- 电压等级:250V
- 绝缘电阻: $\geq 10^9 \Omega$
- 接触电阻: $\leq 5m\Omega$
- 污染等级:3
- 使用环境温度:-40...+75°C
- 可插拔寿命:最小100次

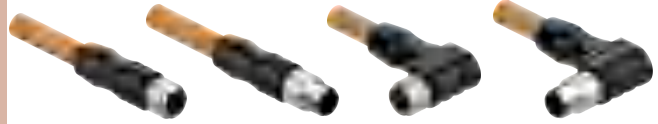

预铸式连接器	型号	订货号	针脚编号分布
<b>直线孔座EK..**</b> 	EK4-2M/F30 EK4-5M/F30 EK4-10M/F30	10016241 10016242 10016243	孔座 
<b>直角孔座ELK..**</b> 	ELK4-2M/F30 ELK4-5M/F30 ELK4-10M/F30	10016244 10016245 10016246	 1.Shield 2.WH (DB) 3.YE (DG) 4.BU (DA)
<b>直线针座EZ..**</b> 	EZ4-2M/F30 EZ4-5M/F30 EZ4-10M/F30	10016247 10016248 10016249	针座 
<b>直角针座ELZ..**</b> 	ELZ4-2M/F30 ELZ4-5M/F30 ELZ4-10M/F30	10016250 10016251 10016252	 1.Shield 2.WH (DB) 3.YE (DG) 4.BU (DA)
	EK4 EZ4-2M/F30 EK4 EZ4-5M/F30 EK4 EZ4-10M/F30	10016253 10016254 10016255	
	EK4 ELZ4-2M/F30 EK4 ELZ4-5M/F30 EK4 ELZ4-10M/F30	10016256 10016257 10016258	1.Shield 2.WH (DB) 3.YE (DG) 4.BU (DA)
	ELK4 EZ4-2M/F30 ELK4 EZ4-5M/F30 ELK4 EZ4-10M/F30	10016259 10016260 10016261	
	ELK4 ELZ4-2M/F30 ELK4 ELZ4-5M/F30 ELK4 ELZ4-10M/F30	10016262 10016263 10016264	1.Shield 2.WH (DB) 3.YE (DG) 4.BU (DA)

\* 标准长度为2/5/10米,可订制任意长度

\*\* 标准锁紧螺母材质为黄铜镀镍

## 7/8" CC-Link 预铸式连接器

- 预铸接头:TPU材质,黑色
- 锁紧螺母:黄铜镀镍
- 针托:TPU材质,黑色
- 触点:黄铜镀金
- 防护等级:IP67
- 电流等级:9A
- 电压等级:300V
- 绝缘电阻: $\geq 10^9 \Omega$
- 接触电阻: $\leq 5m\Omega$
- 污染等级:3
- 使用环境温度: $-40 \dots +75^\circ\text{C}$
- 可插拔寿命:最小100次



预铸式连接器	型号	订货号	针脚编号分布
<b>直线孔座MK..**</b> 	MK4-2M/F30 MK4-5M/F30 MK4-10M/F30	10032172 10032173 10032174	孔座 
<b>直角孔座MLK..**</b> 	MLK4-2M/F30 MLK4-5M/F30 MLK4-10M/F30	10032175 10032176 10032129	
<b>直线针座MZ..**</b> 	MZ4-2M/F30 MZ4-5M/F30 MZ4-10M/F30	10032130 10032131 10032132	针座 
<b>直角针座MLZ..**</b> 	MLZ4-2M/F30 MLZ4-5M/F30 MLZ4-10M/F30	10032133 10032134 10032135	
	MK4 MZ4-2M/F30 MK4 MZ4-5M/F30 MK4 MZ4-10M/F30	10032136 10032137 10032138	
	MK4 MLZ4-2M/F30 MK4 MLZ4-5M/F30 MK4 MLZ4-10M/F30	10032139 10032140 10032141	1.Shield 2.WH (DB) 3.YE (DG) 4.BU (DA)
	MLK4 MZ4-2M/F30 MLK4 MZ4-5M/F30 MLK4 MZ4-10M/F30	10032142 10032143 10032144	
	MLK4 MLZ4-2M/F30 MLK4 MLZ4-5M/F30 MLK4 MLZ4-10M/F30	10032145 10032146 10032147	1.Shield 2.WH (DB) 3.YE (DG) 4.BU (DA)

\* 标准长度为2/5/10米, 可订制任意长度

\*\* 标准锁紧螺母材质为黄铜镀镍

## 7/8" CC-Link 预铸式连接器

- 预铸接头:TPU材质,黑色
- 锁紧螺母:黄铜镀镍
- 针托:TPU材质,黑色
- 触点:黄铜镀金
- 防护等级:IP67
- 电流等级:9A
- 电压等级:300V
- 绝缘电阻: $\geq 10 \Omega$
- 接触电阻: $\leq 5m\Omega$
- 污染等级:3
- 使用环境温度: $-40 \dots +75^\circ\text{C}$
- 可插拔寿命:最小100次



预铸式连接器	型号	订货号	针脚编号分布
<b>直线孔座MK..**</b> 	MK6-2M/S30 MK6-5M/S30 MK6-10M/S30	10032148 10032149 10032150	<b>孔座</b> 
<b>直角孔座MLK..**</b> 	MLK6-2M/S30 MLK6-5M/S30 MLK6-10M/S30	10032151 10032152 10032153	<ol style="list-style-type: none"> <li>1.BU(DA)</li> <li>2.WH (DB)</li> <li>3.YE (DG)</li> <li>4.RD (V+)</li> <li>5.BK (V-)</li> <li>6.Drain (Shield)</li> </ol>
<b>直线针座MZ..**</b> 	MZ6-2M/S30 MZ6-5M/S30 MZ6-10M/S30	10032154 10032155 10032156	<b>针座</b> 
<b>直角针座MLZ..**</b> 	MLZ6-2M/S30 MLZ6-5M/S30 MLZ6-10M/S30	10032157 10032158 10032159	<ol style="list-style-type: none"> <li>1.BU(DA)</li> <li>2.WH (DB)</li> <li>3.YE (DG)</li> <li>4.RD (V+)</li> <li>5.BK (V-)</li> <li>6.Drain (Shield)</li> </ol>
	MK6 MZ6-2M/S30 MK6 MZ6-5M/S30 MK6 MZ6-10M/S30	10032160 10032161 10032162	
	MK6 MLZ6-2M/S30 MK6 MLZ6-5M/S30 MK6 MLZ6-10M/S30	10032163 10032164 10032165	<ol style="list-style-type: none"> <li>1.BU(DA)</li> <li>2.WH (DB)</li> <li>3.YE (DG)</li> <li>4.RD (V+)</li> <li>5.BK (V-)</li> <li>6.Drain (Shield)</li> </ol>
	MLK6 MZ6-2M/S30 MLK6 MZ6-5M/S30 MLK6 MZ6-10M/S30	10032166 10032167 10032168	
	MLK6 MLZ6-2M/S30 MLK6 MLZ6-5M/S30 MLK6 MLZ6-10M/S30	10032169 10032170 10032171	<ol style="list-style-type: none"> <li>1.BU(DA)</li> <li>2.WH (DB)</li> <li>3.YE (DG)</li> <li>4.RD (V+)</li> <li>5.BK (V-)</li> <li>6.Drain (Shield)</li> </ol>

\* 标准长度为2/5/10米, 可订制任意长度

\*\* 标准锁紧螺母材质为黄铜镀镍



法兰连接器	型号	订货号	特性描述	针脚编号分布
<p>M12 预铸前锁紧法兰, 孔座</p>	FEK41-2M/F30	10042226	3x20 AWG 22 AWG屏蔽线 铝箔屏蔽, 镀锡编织网 棕色PVC, Ø7.5mm 电缆型号: 58569661-*M -40°C ~ +75°C 300V, 5A	<p>孔座</p> <ol style="list-style-type: none"> <li>Shield</li> <li>WH (DB)</li> <li>YE (DG)</li> <li>BU (DA)</li> </ol>
<p>M12 预铸前锁紧法兰, 针座</p>	FEZ41-2M/F30	10042227	3x20 AWG 22 AWG屏蔽线 铝箔屏蔽, 镀锡编织网 棕色PVC, Ø7.5mm 电缆型号: 58569661-*M -40°C ~ +75°C 300V, 5A	<p>针座</p> <ol style="list-style-type: none"> <li>Shield</li> <li>WH (DB)</li> <li>YE (DG)</li> <li>BU (DA)</li> </ol>
<p>7/8" 预铸后端锁紧, 孔座</p>	FMK42-2M/NPSM/F30	10041053	3x20 AWG 22 AWG屏蔽线 铝箔屏蔽, 镀锡编织网 棕色PVC, Ø7.5mm 电缆型号: 58569661-*M -40°C ~ +75°C 300V, 5A	<p>孔座</p> <ol style="list-style-type: none"> <li>Shield</li> <li>WH (DB)</li> <li>YE (DG)</li> <li>BU (DA)</li> </ol>
<p>7/8" 预铸后端锁紧, 针座</p>	FMZ42-2M/NPSM/F30	10041054	3x20 AWG 22 AWG屏蔽线 铝箔屏蔽, 镀锡编织网 棕色PVC, Ø7.5mm 电缆型号: 58569661-*M -40°C ~ +75°C 300V, 5A	<p>针座</p> <ol style="list-style-type: none"> <li>Shield</li> <li>WH (DB)</li> <li>YE (DG)</li> <li>BU (DA)</li> </ol>
<p>7/8" 预铸后端锁紧, 孔座</p>	FMK62-2M/NPSM/S30	10041055	2x19+18 AWG 22 AWG屏蔽线 铝箔屏蔽, 镀锡编织网 棕色PVC, Ø12mm 电缆型号: 58501661-*M -40°C ~ +75°C 300V, 5A	<p>孔座</p> <ol style="list-style-type: none"> <li>BU (DA)</li> <li>WH (DB)</li> <li>YE (DG)</li> <li>RD (V+)</li> <li>BK (V-)</li> <li>Drain (Shield)</li> </ol>
<p>7/8" 预铸后端锁紧, 针座</p>	FMZ62-2M/NPSM/S30	10041056	2x19+18 AWG 22 AWG屏蔽线 铝箔屏蔽, 镀锡编织网 棕色PVC, Ø12mm 电缆型号: 58501661-*M -40°C ~ +75°C 300V, 5A	<p>针座</p> <ol style="list-style-type: none"> <li>BU (DA)</li> <li>WH (DB)</li> <li>YE (DG)</li> <li>RD (V+)</li> <li>BK (V-)</li> <li>Drain (Shield)</li> </ol>



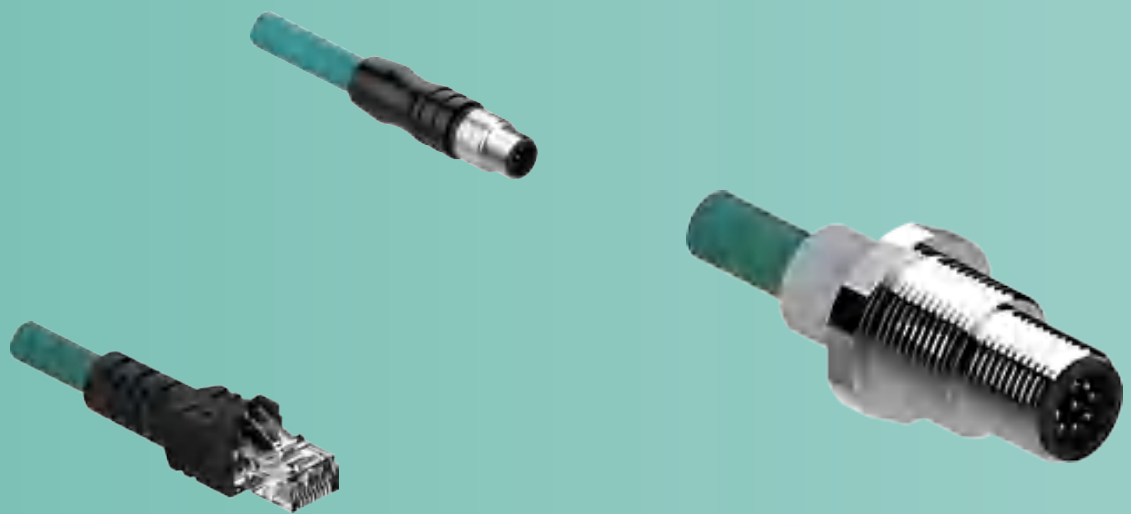

## ■ Ethernet 协议通讯连接器

## 预铸式连接器

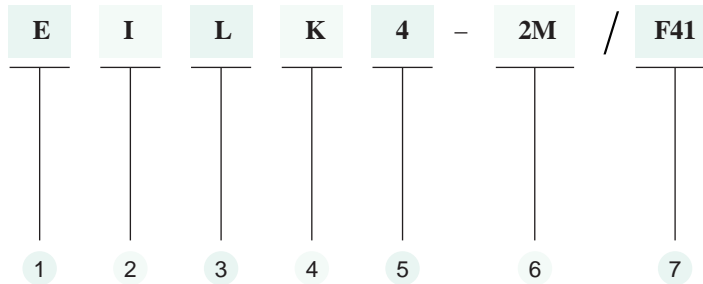

- |  |                               |  |
|--|-------------------------------|--|
| <p><b>1</b> E M12x1连接器<br/>S M8x1连接器</p>     | <p><b>4</b> K 孔座<br/>Z 针座</p> | <p><b>7</b> 线缆材质代码<br/>F41 PVC固定安装<br/>F410 PUR拖链<br/>E41 PUR固定安装<br/>E45 PUR拖链<br/>E61 PVC固定安装<br/>E65 PVC拖链<br/>E71 PUR固定安装<br/>F21 PVC固定安装<br/>F23 PUR拖链<br/>F230 PUR拖链</p> |
| <p><b>2</b> I 工业以太网型<br/>IX X-code以太网连接器</p> | <p><b>5</b> 针脚数<br/>编号分配</p>  |  |
| <p><b>3</b> Blank 直线型<br/>L 直角型</p>          | <p><b>6</b> 线缆长度[m]</p>       |  |

## RJ45预铸式连接器

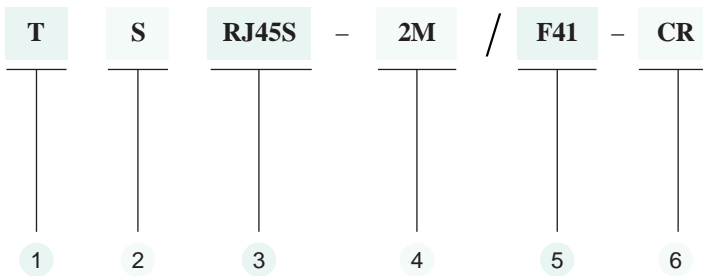

- |   |  |
|---|--|
| <p><b>1</b> Blank 直线型, 卡扣向上<br/>T 直角型, 卡扣向上<br/>B 直角型, 卡扣向下<br/>CU 直线型, 螺钉锁紧<br/>D 直线型, 短护套型<br/>M 直线型, 小外型</p> | <p><b>5</b> 线缆材质代码<br/>F41 PVC固定安装<br/>F410 PUR拖链<br/>E41 PUR固定安装<br/>E43 PVC拖链<br/>E45 PUR拖链<br/>E61 PVC固定安装<br/>E65 PVC拖链<br/>E71 PUR固定安装<br/>F21 PVC固定安装<br/>F23 PUR拖链<br/>F230 PUR拖链</p> |
| <p><b>2</b> Blank 普通卡扣RJ45<br/>S 快速解锁型RJ45</p>  |  |
| <p><b>3</b> RJ45S 屏蔽工业以太网型</p>  |  |
| <p><b>4</b> 线缆长度[m]</p>   | <p><b>6</b> 线序<br/>Blank 标准线序<br/>CR 交叉线序</p>  |

## 双端预铸型号举例



EIK4 EIZ4-\*M/F41



SIK4 SIZ4-\*M/F230



EIK4 RJ45S-\*M/F41



SIK4 RJ45S-\*M/F230

## 预铸法兰连接器

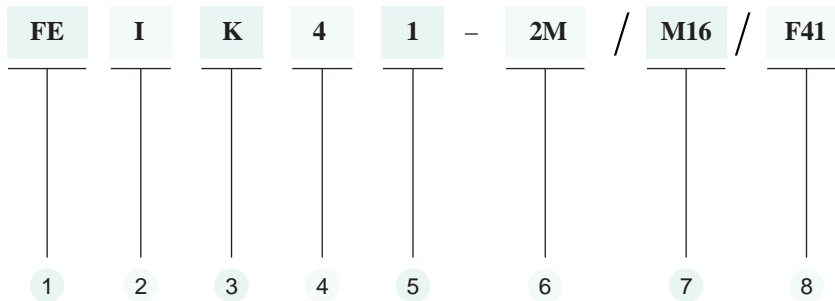

- 1 FE M12x1法兰连接器
- 2 I 工业以太网型  
IX X-code以太网连接器
- 3 K 孔座  
Z 针座
- 4 针脚数  
编号分配

- 5 连接方式  
1 前端拧紧  
2 后端拧紧
- 6 线缆长度[m]
- 7 穿板位置尺寸  
Blank PG9  
M16 M16\*1.5

- 8 线缆材质代码
- |      |         |
|------|---------|
| F41  | PVC固定安装 |
| F410 | PUR拖链   |
| E41  | PUR固定安装 |
| E45  | PUR拖链   |
| E61  | PVC固定安装 |
| E65  | PVC拖链   |
| E71  | PUR固定安装 |
| F21  | PVC固定安装 |
| F23  | PUR拖链   |
| F230 | PUR拖链   |

# 工业以太网电缆型号

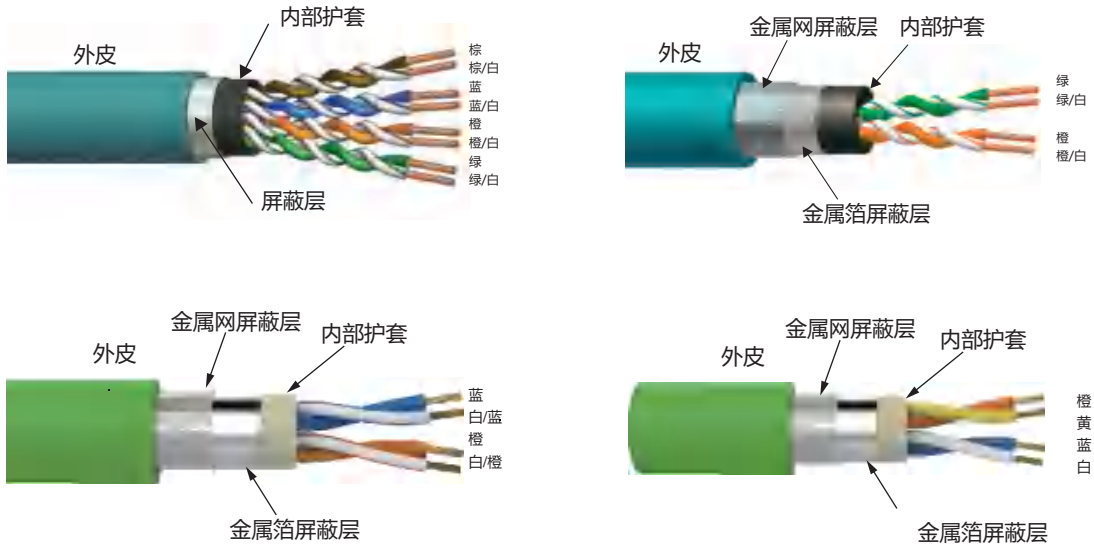

电缆型号	认证	数据参数		外皮 材质、颜色 外径尺寸	屏蔽类型	后缀代码	应用环境
		线缆	每1000米的 直流电阻/绝缘				
58103504-*M	UL AWM 2095	2*2*24AWG	85.9 Ω PE	PVC蓝绿色 5.6mm	金属箔/金属网	F41 80°C 300 Volts	Cat.5e 固定安装
58107501-*M	UL AWM 21576 IEC 60332-1-2 IEC 60754-2	2*2*26AWG	140 Ω PE	PUR蓝绿色 5.9mm	金属箔/金属网	F410 80°C 125 Volts	Cat.5e 拖链安装≥500万
58110311-*M	UL AWM 20963	4*2*26AWG	290 Ω PE	PUR蓝绿色 6.4mm	金属箔/金属网	E41 80°C 100 Volts	Cat.5e 固定安装
58125311-*M	UL 758 IEC 60754-1 IEC 60332-1-2	4*2*26AWG	145 Ω PE	PUR蓝绿色 6.9mm	金属箔/金属网	E45 60°C 30 Volts	Cat.5e 拖链安装≥500万
58111311-*M	UL AWM 20276	4*2*24AWG	190 Ω PE	PVC黄绿色 8.0mm	金属箔/金属网	E61 80°C 100 Volts	Cat.6 固定安装
58026161-*M	UL 1581 IEC 60332-1-2 IEC 60227-1	4*2*26AWG	148 Ω PE	PUR黄绿色 6.4mm	金属箔/金属网	E612 80°C 30 Volts	Cat.6A 固定安装
58121311-*M	UL 1685 ICE 60332-3-24	4*2*24AWG	180 Ω PE	PVC黄绿色 8.0mm	金属箔/金属网	E65 75°C 100 Volts	Cat.6 拖链安装≥100万
58005161-*M	UL 758 UL 20236	4*2*26AWG	138 Ω	PUR黄绿色 7.2mm	金属箔/金属网	E66 80°C 30 Volts	Cat.6 拖链安装≥1000万
58006311-*M	UL Style 20963 ICE 60332-1-2 ICE 60811-2-1	4*2*23AWG	146 Ω PE	PUR黄绿色 8.0mm	金属箔/金属网	E71 80°C 30 Volts	Cat.7 固定安装
58006161-*M	UL 758、UL 1581 IEC 60332-1-2 ISO/IEC11801	4*22AWG	115 Ω PE	PVC黄绿色 6.5mm	金属箔/金属网	F21 60°C 300 Volts	Cat.5e 固定安装
58108312-*M	UL 758、UL 1581 IEC60288-2-2 ISO /IEC 11801	4*22AWG	57.1 Ω HDPE	PUR黄绿色 6.4mm	金属箔/金属网	F23 80°C 300 Volts	Cat.5e 拖链安装≥500万
58549761-*M	UL 758 AWM 20554 ISO/IEC11801	4*26AWG	140 Ω PE	PUR 黄绿色 4.8mm	金属箔/金属网	F230 80°C 140 Volts	Cat.5e 拖链安装≥500万
58549763-*M	UL-Style 20963	4*26AWG	280 Ω PE	PUR 黄绿色 4.8mm	金属箔/金属网	F211 80°C 30 Volts	Cat.5e 固定安装



连接器类型	型号	订货号	针脚编号分布
<p>M12预铸直线孔座</p>	<p>EIK8-2M/E41 EIK8-5M/E41 EIK8-10M/E41</p>	<p>10017100 10017113 10017114</p>	<p>孔座</p> <p>1.WH/BU 2.WH/BN 3.BN 4.OR 5.WH/GN 6.WH/OR 7.BU 8.GN</p>
<p>M12预铸直线针座</p>	<p>EIZ8-2M/E41 EIZ8-5M/E41 EIZ8-10M/E41</p>	<p>10017105 10017103 10017104</p>	
<p>M12预铸直角孔座</p>	<p>EILK8-2M/E41 EILK8-5M/E41 EILK8-10M/E41</p>	<p>10017110 10017117 10017118</p>	<p>针座</p>
<p>M12预铸直角针座</p>	<p>EILZ8-2M/E41 EILZ8-5M/E41 EILZ8-10M/E41</p>	<p>10017115 10017119 10017121</p>	
<p>M12法兰孔座</p>	<p>FEIK81-2M/E41 FEIK81-5M/E41 FEIK81-10M/E41</p>	<p>10017375 10017101 10017102</p>	<p>孔座</p> <p>1.WH/BU 5.WH/GN 2.WH/BN 6.WH/OR 3.BN 7.BU 4.OR 8.GN</p>
<p>M12法兰针座</p>	<p>FEIZ81-2M/E41 FEIZ81-5M/E41 FEIZ81-10M/E41</p>	<p>10017380 10017122 10017123</p>	

• 标准长度为 2/5/10米,可订制任意长度

\*\* 双端连接器的命名规则为先孔座再针座,先预铸后法兰,先直线后直角的原则命名

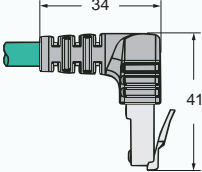
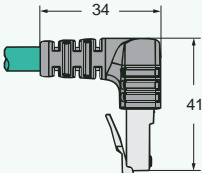
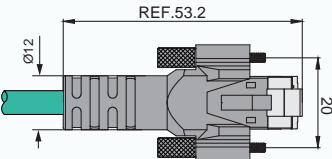

连接器类型	型号	订货号	针脚编号分布
RJ45直线型 	RJ45S-2M/E41 RJ45S-5M/E41 RJ45S-10M/E41	10250000 10250416 10250333	标准线序 1.WH/OR 2.OR 3.WH/GN 4.BU 5.WH/BU 6.GN 7.WH/BN 8.BN 交叉线序 1.WH/GN 2.GN 3.WH/OR 4.BU 5.WH/BU 6.OR 7.WH/BN 8.BN
RJ45直角型 卡扣向上 	TRJ45S-2M/E41 TRJ45S-5M/E41 TRJ45S-10M/E41	10250010 10255068 10255069	
RJ45直角型 卡扣向下 	BRJ45S-2M/E41 BRJ45S-5M/E41 BRJ45S-10M/E41	10255070 10255071 10255072	
RJ45直线型 螺钉锁紧 	CURJ45S-2M/E41 CURJ45S-5M/E41 CURJ45S-10M/E41	10250330 10250500 10250501	



\* 标准长度为2/5/10米,可订制任意长度

\*\* 双端连接器的命名规则为先孔座再针座,先预铸后法兰,先直线后直角的原则命名

# 4针工业以太网连接器Ethernet/IP™.Modbus™TCP





连接器类型	型号	订货号	针脚编号分布
<b>M12预铸直线孔座</b> 	EIK4-2M/F41 EIK4-5M/F41 EIK4-10M/F41	10017210 10056001 10056002	<p>孔座</p>
<b>M12预铸直线针座</b> 	EIZ4-2M/F41 EIZ4-5M/F41 EIZ4-10M/F41	10017215 10255073 10255074	
<b>M12预铸直角孔座</b> 	EILK4-2M/F41 EILK4-5M/F41 EILK4-10M/F41	10017220 10056011 10056012	<p>针座</p>
<b>M12预铸直角针座</b> 	EILZ4-2M/F41 EILZ4-5M/F41 EILZ4-10M/F41	10017225 10255075 10017368	
<b>M12法兰孔座</b> 	FEIK41-2M/F41 FEIK41-5M/F41 FEIK41-10M/F41	10017395 10055005 10055006	<p>孔座</p>
<b>M12法兰针座</b> 	FEIZ41-2M/F41 FEIZ41-5M/F41 FEIZ41-10M/F41	10017400 10055007 10055008	

\* 标准长度为2/5/10米,可订制任意长度

\*\* 双端连接器的命名规则为先孔座再针座,先预铸后法兰,先直线后直角的原则命名

# 4针工业以太网连接器Ethernet/IP™.Modbus™TCP

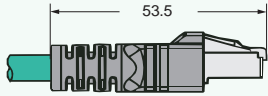

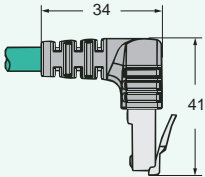
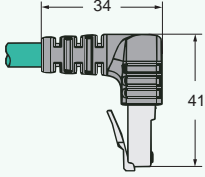
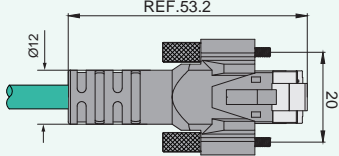
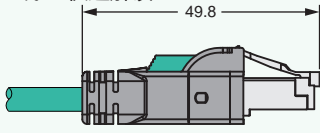
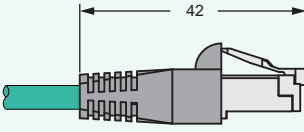
连接器类型	型号	订货号	针脚编号分布
RJ45直线型 	RJ45S-2M/F41 RJ45S-5M/F41 RJ45S-10M/F41	10250040 10250045 10250317	 标准线序 1.WH/OR 2.OR 3.WH/GN 4.N/C 5.N/C 6.GN 7.N/C 8.N/C  交叉线序 1.WH/GN 2.GN 3.WH/OR 4.N/C 5.N/C 6.OR 7.N/C 8.N/C  *交叉线序型号: RJ45S-*M/F41-CR TRJ45S-*M/F41-CR BRJ45S-*M/F41-CR CURJ45S-*M/F41-CR
RJ45直角型 卡扣向上 	TRJ45S-2M/F41 TRJ45S-5M/F41 TRJ45S-10M/F41	10250050 10255060 10255061	
RJ45直角型 卡扣向下 	BRJ45S-2M/F41 BRJ45S-5M/F41 BRJ45S-10M/F41	10250060 10255062 10255063	
RJ45直线型 螺钉锁紧 	CURJ45S-2M/F41 CURJ45S-5M/F41 CURJ45S-10M/F41	10250327 10151200 10151201	
RJ45直线型 快速解锁 	SRJ45S-2M/F41 SRJ45S-5M/F41 SRJ45S-10M/F41	10250427 10250691 10250692	
RJ45直线型 短型 	DRJ45S-2M/F41 DRJ45S-5M/F41 DRJ45S-10M/F41	10255197 10255198 10255199	

\* 标准长度为2/5/10米,可订制任意长度

\*\* 双端连接器的命名规则为先孔座再针座,先预铸后法兰,先直线后直角的原则命名



连接器类型	型号	订货号	特性	针脚编号分布
<p>M12直线孔座</p>	EK4238-0/9	10091339	4A,250V,-40 ~ +85°C 可与4针D-coded M12预铸式 法兰式连接器对接	<p>针座</p>
<p>M12直线针座</p>	EZ4238-0/9	10091320		<p>孔座</p>
<p>M12直角孔座</p>	ELK4238-0/9	10091471		
<p>M12直角针座</p>	ELZ4238-0/9	10091094		
<p>RJ45直线型全金属 活接头</p>	RJ45/GHM	12502437		AWG24-AWG22线缆规格 电缆外径范围:5-7mm
<p>RJ45直角型全金属 活接头</p>	RJ45/GLHM0	10258264	70°C, 50V, 1.75 A 10/100Mbps	

# 8针工业以太网连接器Ethernet/IP™.CAT6E





连接器类型	型号	订货号	针脚编号分布
<p>M12预铸直线孔座</p>	<p>EIK8-2M/E61 EIK8-5M/E61 EIK8-10M/E61</p>	<p>10017470 10017471 10017472</p>	<p>孔座</p> <p>1.WH/BU 2.WH/BN 3.BN 4.OR 5.WH/GN 6.WH/OR 7.BU 8.GN</p>
<p>M12预铸直线针座</p>	<p>EIZ8-2M/E61 EIZ8-5M/E61 EIZ8-10M/E61</p>	<p>10017473 10017474 10017475</p>	
<p>M12预铸直角孔座</p>	<p>EILK8-2M/E61 EILK8-5M/E61 EILK8-10M/E61</p>	<p>10017476 10017477 10017478</p>	<p>针座</p>
<p>M12预铸直角针座</p>	<p>EILZ8-2M/E61 EILZ8-5M/E61 EILZ8-10M/E61</p>	<p>10017479 10017480 10017481</p>	
<p>M12预铸法兰孔座</p>	<p>FEIK81-2M/E61 FEIK81-5M/E61 FEIK81-10M/E61</p>	<p>10017490 10017491 10017492</p>	<p>孔座</p> <p>1.WH/BU 5.WH/GN 2.WH/BN 6.WH/OR 3.BN 7.BU 4.OR 8.GN</p>
<p>M12预铸法兰针座</p>	<p>FEIZ81-2M/E61 FEIZ81-5M/E61 FEIZ81-10M/E61</p>	<p>10017493 10017494 10017495</p>	

\* 标准长度为2/5/10米,可订制任意长度

\*\* 双端连接器的命名规则为先孔座再针座,先预铸后法兰,先直线后直角的原则命名

# 8针工业以太网连接器Ethernet/IP™.CAT6E

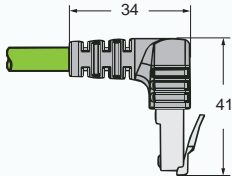
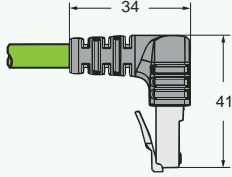
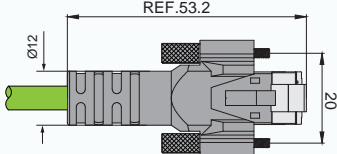

连接器类型	型号	订货号	针脚编号分布
RJ45直线型 	RJ45S-2M/E61 RJ45S-5M/E61 RJ45S-10M/E61	10255400 10255401 10255402	标准线序 1.WH/OR 2.OR 3.WH/GN 4.BU 5.WH/BU 6.GN 7.WH/BN 8.BN   12345678  交叉线序 1.WH/GN 2.GN 3.WH/OR 4.BU 5.WH/BU 6.OR 7.WH/BN 8.BN  *交叉线序型号: RJ45S-*M/E41-CR TRJ45S-*M/E41-CR BRJ45S-*M/E41-CR CRJ45S-*M/E41-CR
RJ45直角型 卡扣向上 	TRJ45S-2M/E61 TRJ45S-5M/E61 TRJ45S-10M/E61	10255403 10255404 10255405	
RJ45直角型 卡扣向下 	BRJ45S-2M/E61 BRJ45S-5M/E61 BRJ45S-10M/E61	10255406 10255407 10255408	
RJ45直线型 螺钉锁紧 	CURJ45S-2M/E61 CURJ45S-5M/E61 CURJ45S-10M/E61	10255409 10255410 10255411	

\* 标准长度为2/5/10米,可订制任意长度

\*\* 双端连接器的命名规则为先孔座再针座,先预铸后法兰,先直线后直角的原则命名

# 8针工业以太网连接器Ethernet/IP™.Modbus™TCP



连接器类型	型号	订货号	针脚编号分布
<p>M12预铸直线孔座</p>	<p>EIXK8-2M/E61 EIXK8-5M/E61 EIXK8-10M/E61</p>	<p>12020477 10093293 10093294</p>	<p>孔座</p> <p>1.WH/OR 2.OR 3.WH/GN 4.GN 5.WH/BN 6.BN 7.WH/BU 8.BU</p> <p>针座</p>
<p>M12预铸直线针座</p>	<p>EIXZ8-2M/E61 EIXZ8-5M/E61 EIXZ8-10M/E61</p>	<p>10017497 10017498 10017499</p>	
<p>M12预铸直角孔座</p>	<p>EIXLK8-2M/E61 EIXLK8-5M/E61 EIXLK8-10M/E61</p>	<p>10093295 10093296 10093297</p>	
<p>M12预铸直角针座</p>	<p>EIXLZ8-2M/E61 EIXLZ8-5M/E61 EIXLZ8-10M/E61</p>	<p>10017567 10093298 10093299</p>	
<p>M12预铸法兰孔座</p>	<p>FEIXK81-2M/E61 FEIXK81-5M/E61 FEIXK81-10M/E61</p>	<p>10093300 10093301 10093302</p>	
<p>M12 前端锁紧, PCB 孔座</p>	<p>FEIXK81-P/D</p>	<p>10259015</p>	

\* 标准长度为2/5/10米,可订制任意长度

\*\* 双端连接器的命名规则为先孔座再针座,先预铸后法兰,先直线后直角的原则命名





连接器类型	型号	订货号	针脚编号分布
<p>M12预铸直线孔座</p>	<p>EIK4-2M/F21 EIK4-5M/F21 EIK4-10M/F21</p>	<p>10110164 10255064 10255065</p>	<p>孔座</p>
<p>M12预铸直线针座</p>	<p>EIZ4-2M/F21 EIZ4-5M/F21 EIZ4-10M/F21</p>	<p>10015047 10015037 10017218</p>	<p>针座</p>
<p>M12预铸直角孔座</p>	<p>EILK4-2M/F21 EILK4-5M/F21 EILK4-10M/F21</p>	<p>10110165 10255066 10255067</p>	<p>孔座</p>
<p>M12预铸直角针座</p>	<p>EILZ4-2M/F21 EILZ4-5M/F21 EILZ4-10M/F21</p>	<p>10017367 10017318 10017309</p>	<p>针座</p>
<p>M12预铸法兰孔座</p>	<p>FEIK41-2M/F21 FEIK41-5M/F21 FEIK41-10M/F21</p>	<p>10255076 10255077 10255078</p>	<p>孔座</p>
<p>M12预铸法兰针座</p>	<p>FEIZ41-2M/F21 FEIZ41-5M/F21 FEIZ41-10M/F21</p>	<p>10255079 10255080 10255081</p>	<p>针座</p>

\* 标准长度为2/5/10米,可订制任意长度

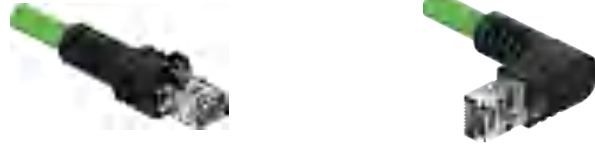
\*\* 双端连接器的命名规则为先孔座再针座,先预铸后法兰,先直线后直角的原则命名

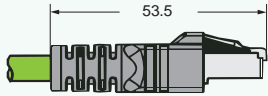

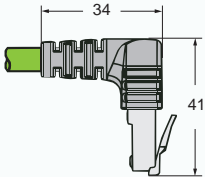
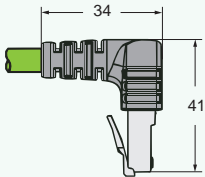
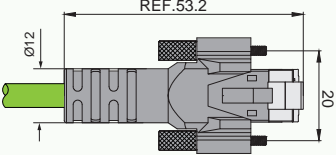
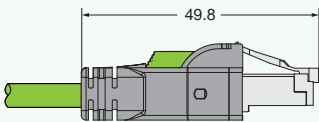
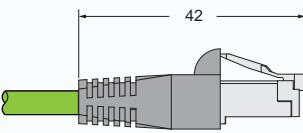
连接器类型	型号	订货号	针脚编号分布
RJ45直线型 	RJ45S-2M/F21 RJ45S-5M/F21 RJ45S-10M/F21	10250003 10250419 10250420	 <p>1.YE 2.OR 3.WH 4.N/C 5.N/C 6.BU 7.N/C 8.N/C</p>
RJ45直角型 卡扣向上 	TRJ45S-2M/F21 TRJ45S-5M/F21 TRJ45S-10M/F21	10250081 10255082 10255083	
RJ45直角型 卡扣向下 	BRJ45S-2M/F21 BRJ45S-5M/F21 BRJ45S-10M/F21	10255084 10255085 10255086	
RJ45直线型 螺钉锁紧 	CURJ45S-2M/F21 CURJ45S-5M/F21 CURJ45S-10M/F21	10255087 10255088 10255089	
RJ45直线型 快速解锁 	SRJ45S-2M/F21 SRJ45S-5M/F21 SRJ45S-10M/F21	10250292 10250392 10255429	
RJ45直线型 短型 	DRJ45S-2M/F21 DRJ45S-5M/F21 DRJ45S-10M/F21	10255430 10255431 10255432	

\* 标准长度为2/5/10米,可订制任意长度

\*\* 双端连接器的命名规则为先孔座再针座,先预铸后法兰,先直线后直角的原则命名



连接器类型	型号	订货号	针脚编号分布
M8 预铸直线孔座 	SIK4-2M/F230 SIK4-5M/F230 SIK4-10M/F230	10020266 10020267 10020268	孔座  1. Orange/White (+tx) 2. Blue/White(+rx) 3. Blue(-rx) 4. Orange(-tx)
M8 预铸直线针座 	SIZ4-2M/F230 SIZ4-5M/F230 SIZ4-10M/F230	10020269 10020270 10020271	
M8 预铸直角孔座 	SILK4-2M/F230 SILK4-5M/F230 SILK4-10M/F230	10020272 10020273 10020274	针座  1. Orange/White (+tx) 2. Blue/White(+rx) 3. Orange(-tx) 4. Blue(-rx)
M8 预铸直角针座 	SILZ4-2M/F230 SILZ4-5M/F230 SILZ4-10M/F230	10020275 10020276 10020277	
M8 预铸直线针座 	SDZ4 SDZ4-2M/F230 SDZ4 SDZ4-5M/F230 SDZ4 SDZ4-10M/F230	10258833 10258832 10258834	针座  1. Orange/White (+tx) 2. Blue/White(+rx) 3. Orange(-tx) 4. Blue(-rx)
M8 预铸直角针座 	SDLZ4 SDLZ4-2M/F230 SDLZ4 SDLZ4-5M/F230 SDLZ4 SDLZ4-10M/F230	10258657 10258658 10258659	

\* 标准长度为2/5/10米,可订制任意长度

\*\* 双端连接器的命名规则为先孔座再针座,先预铸后法兰,先直线后直角的原则命名



连接器类型	型号	订货号	针脚编号分布
<p>M12预铸直线孔座</p>	<p>EIK4-2M/F230 EIK4-5M/F230 EIK4-10M/F230</p>	<p>10016265 10016266 10016267</p>	<p>孔座</p> <p>1. Orange/White (+tx) 2. Blue/White(+rx) 3. Orange(-tx) 4. Blue(-rx)</p>
<p>M12预铸直线针座</p>	<p>EIZ4-2M/F230 EIZ4-5M/F230 EIZ4-10M/F230</p>	<p>10016268 10016269 10016270</p>	
<p>M12预铸直角孔座</p>	<p>EILK4-2M/F230 EILK4-5M/F230 EILK4-10M/F230</p>	<p>10016271 10016272 10016273</p>	<p>针座</p>
<p>M12预铸直角针座</p>	<p>EILZ4-2M/F230 EILZ4-5M/F230 EILZ4-10M/F230</p>	<p>10016274 10016275 10016276</p>	
<p>M12预铸法兰孔座</p>	<p>FEIK41-2M/F230 FEIK41-5M/F230 FEIK41-10M/F230</p>	<p>10041057 10041058 10041059</p>	<p>孔座</p> <p>1. Orange/White (+tx) 2. Blue/White(+rx) 3. Orange(-tx) 4. Blue(-rx)</p>
<p>M12预铸法兰针座</p>	<p>FEIZ41-2M/F230 FEIZ41-5M/F230 FEIZ41-10M/F230</p>	<p>10041060 10041037 10041038</p>	

\* 标准长度为2/5/10米,可订制任意长度

\*\* 双端连接器的命名规则为先孔座再针座,先预铸后法兰,先直线后直角的原则命名

\*\*\* M8可接线缆代号为: F230/F231/F211/F21/F23

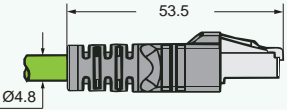
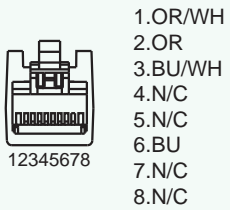
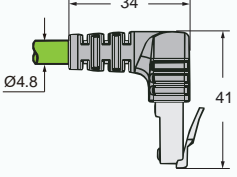
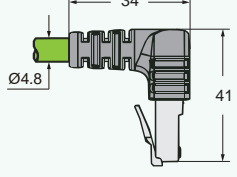
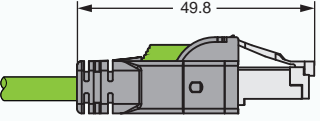
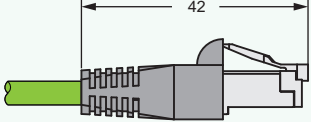

连接器类型	型号	订货号	针脚编号分布
RJ45直线型 	RJ45S-2M/F230 RJ45S-5M/F230 RJ45S-10M/F230	10250374 10250375 10250376	
RJ45直角型 卡扣向上 	TRJ45S-2M/F230 TRJ45S-5M/F230 TRJ45S-10M/F230	10250377 10250378 10250379	
RJ45直角型 卡扣向下 	BRJ45S-2M/F230 BRJ45S-5M/F230 BRJ45S-10M/F230	10250380 10250381 10250382	
RJ45直线型 快速解锁 	SRJ45S-2M/F230 SRJ45S-5M/F230 SRJ45S-10M/F230	10093303 10093304 10093305	
RJ45直线型 短型 	DRJ45S-2M/F230 DRJ45S-5M/F230 DRJ45S-10M/F230	10093306 10093307 10093308	

\* 标准长度为2/5/10米,可订制任意长度

\*\* 双端连接器的命名规则为先孔座再针座,先预铸后法兰,先直线后直角的原则命名



连接器类型	型号	订货号	引脚编号分布
<b>M8 预铸直线孔座</b> 	SIK4-2M/F211 SIK4-5M/F211 SIK4-10M/F211	10020254 10020255 10020256	孔座 
<b>M8 预铸直线针座</b> 	SIZ4-2M/F211 SIZ4-5M/F211 SIZ4-10M/F211	10020257 10020258 10020259	
<b>M8 预铸直角孔座</b> 	SILK4-2M/F211 SILK4-5M/F211 SILK4-10M/F211	10020260 10020261 10020262	针座 
<b>M8 预铸直角针座</b> 	SILZ4-2M/F211 SILZ4-5M/F211 SILZ4-10M/F211	10020263 10020264 10020265	

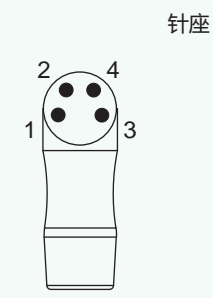
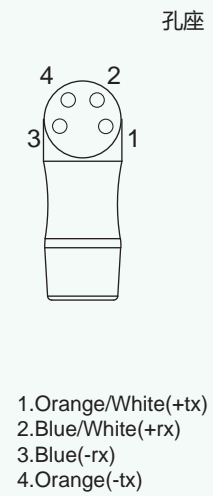

\* 标准长度为2/5/10米,可订制任意长度

\*\* 双端连接器的命名规则为先孔座再针座,先预铸后法兰,先直线后直角的原则命名





连接器类型	型号	订货号	针脚编号分布
<p>M12预铸直线孔座</p>	<p>EIK4-2M/F211 EIK4-5M/F211 EIK4-10M/F211</p>	<p>10016277 10016278 10016279</p>	<p>孔座</p> <p>1. Orange/White (+tx) 2. Blue/White(+rx) 3. Orange(-tx) 4. Blue(-rx)</p>
<p>M12预铸直线针座</p>	<p>EIZ4-2M/F211 EIZ4-5M/F211 EIZ4-10M/F211</p>	<p>10016280 10016281 10016282</p>	
<p>M12预铸直角孔座</p>	<p>EILK4-2M/F211 EILK4-5M/F211 EILK4-10M/F211</p>	<p>10016283 10016284 10016285</p>	<p>针座</p>
<p>M12预铸直角针座</p>	<p>EILZ4-2M/F211 EILZ4-5M/F211 EILZ4-10M/F211</p>	<p>10016286 10016287 10016288</p>	
<p>M12法兰孔座</p>	<p>FEIK41-2M/F211 FEIK41-5M/F211 FEIK41-10M/F211</p>	<p>10041045 10041046 10041047</p>	<p>孔座</p> <p>1. Orange/White (+tx) 2. Blue/White(+rx) 3. Orange(-tx) 4. Blue(-rx)</p>
<p>M12法兰针座</p>	<p>FEIZ41-2M/F211 FEIZ41-5M/F211 FEIZ41-10M/F211</p>	<p>10041048 10041049 10041050</p>	

\* 标准长度为2/5/10米,可订制任意长度

\*\* 双端连接器的命名规则为先孔座再针座,先预铸后法兰,先直线后直角的原则命名

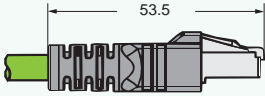

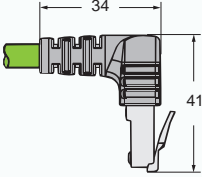
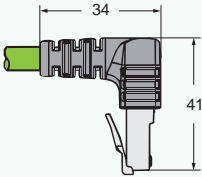
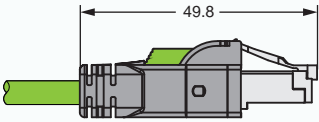
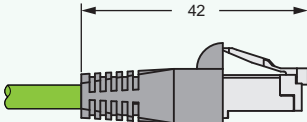
连接器类型	型号	订货号	针脚编号分布
RJ45直线型 	RJ45S-2M/F211 RJ45S-5M/F211 RJ45S-10M/F211	10250383 10250384 10250385	 12345678 1.OR/WH 2.OR 3.BU/WH 4.N/C 5.N/C 6.BU 7.N/C 8.N/C
RJ45直角型 卡扣向上 	TRJ45S-2M/F211 TRJ45S-5M/F211 TRJ45S-10M/F211	10250386 10250387 10250388	
RJ45直角型 卡扣向下 	BRJ45S-2M/F211 BRJ45S-5M/F211 BRJ45S-10M/F211	10250389 10250390 10250391	
RJ45直线型 快速解锁 	SRJ45S-2M/F211 SRJ45S-5M/F211 SRJ45S-10M/F211	10093309 10093310 10093311	
RJ45直线型 短型 	DRJ45S-2M/F211 DRJ45S-5M/F211 DRJ45S-10M/F211	10093312 10093313 10093314	

\* 标准长度为2/5/10米,可订制任意长度

\*\* 双端连接器的命名规则为先孔座再针座,先预铸后法兰,先直线后直角的原则命名

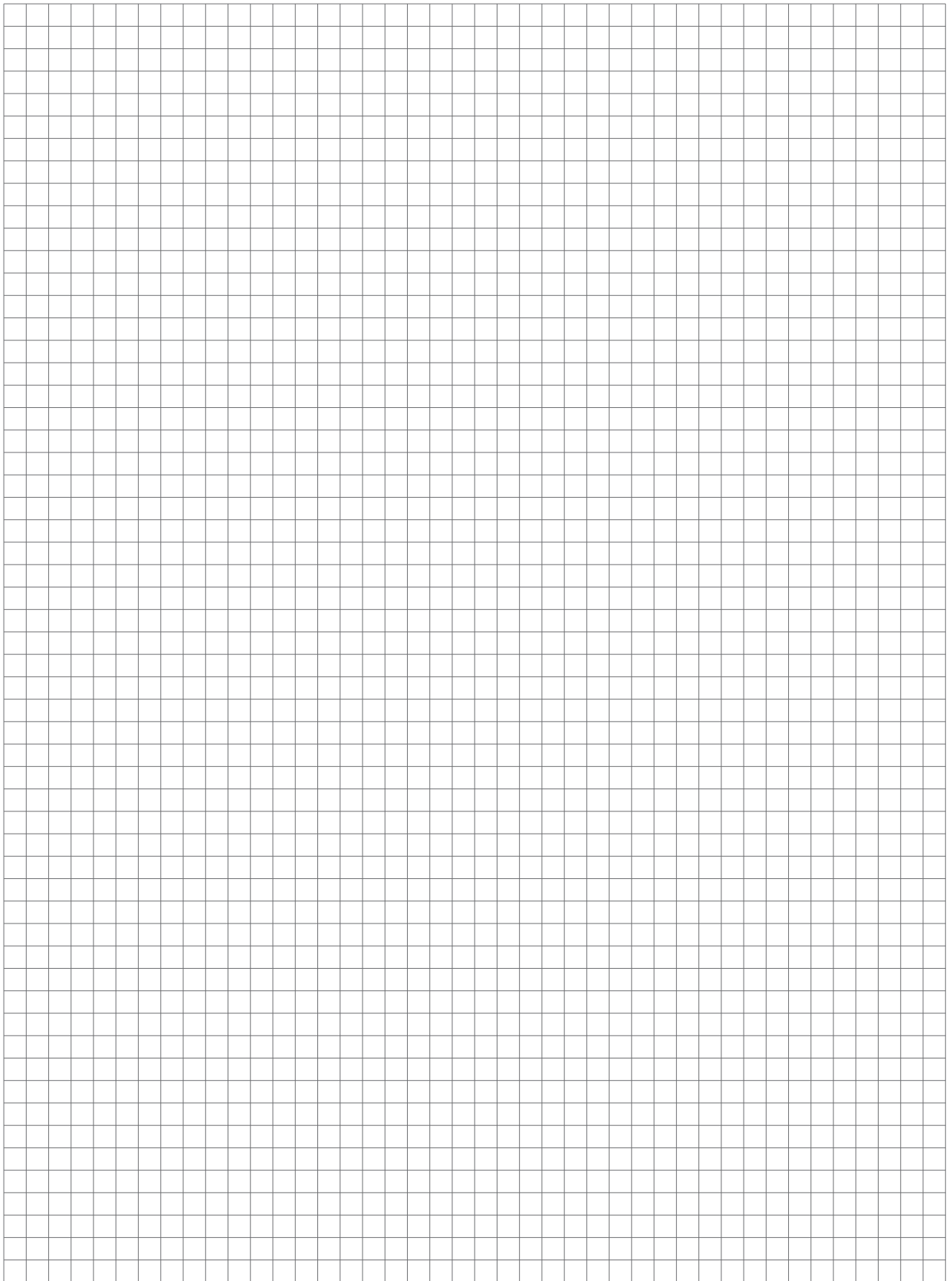

## M8常用

Code型	3 芯		4 芯		5 芯		6 芯		8 芯	
	针	孔	针	孔	针	孔	针	孔	针	孔
A										
B										
D										

## M12常用



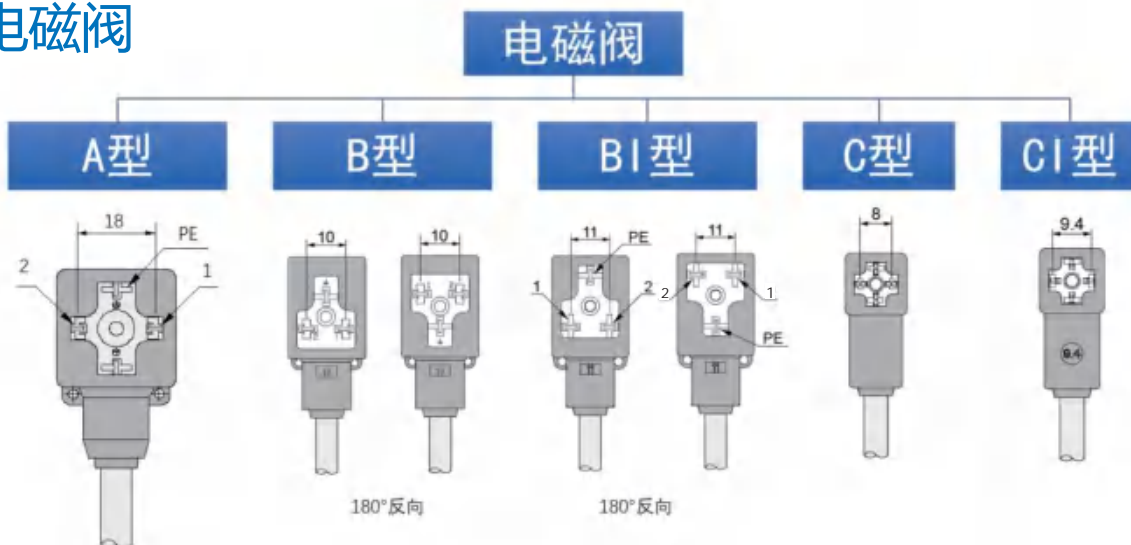

## 电磁阀













电缆	型号	导线数	截面积 (mm <sup>2</sup> )	外径/颜色 护套/绝缘 材质	导线颜色	屏蔽	工作 温度 (°C)	型号 代码	货号
	58016231-*M	2	2*0.34	Ø5.2mm / BU PVC / PVC	BN,BU	无	80 -40	/ P00	58016231
	58021151-*M	2	2*0.34	Ø5.2mm / BK PVC / PVC	BU,BK	无	80 -40	/ P00	58021151
	580E2351-*M	3	3*0.25	Ø4.4mm / BK PVC/ PVC	BN,BU,BK	无	80 -40	/ P00	580E2351
	58005251-*M	3	3*0.34	Ø5.2mm / BK PVC / PVC	BN,BU,BK	无	80 -40	/ P00	58005251
	58004251-*M	3	3*0.34	Ø5.2mm / OR 照射PVC / PVC 抗焊渣	BN,BU,BK	无	105 -40	/ P01	58004251
	58620351-*M	3	3* 0.34	Ø5.2mm / BK PUR / PVC	BN,BU,BK	无	80 -40	/ P10	58620351
	58003231-*M	3	3*0.34	Ø5.2mm / YE PUR / PUR 无卤,高柔性	BN,BU,BK	无	80 -40	/ P11	58003231
	58008351-*M	3	3*0.34	Ø5.2mm / BK PVC / PVC 屏蔽	BN,BU,BK	Braid	80 -40	/ S10	58008351
	58000231-*M	3	3*0.34	Ø5.2mm / GY PVC / PVC	BN,BU,BK	无	80 -40	/ P00	58000231
	58020251-*M	3	3* 0.75	Ø6.0mm / BK PVC / PVC	BN,BU,BK	无	80 -40	/ P00	58020251
	58448911-*M	3	3* 0.75	Ø6.0mm / BK PVC / PVC	BN,BU,GN/YE	无	80 -40	/ P00	58448911
	580E1351-*M	4	4*0.25	Ø4.4mm / BK PVC / PVC	BN,BU,BK,WH	无	80 -40	/ P00	580E1351
	58019252-*M	4	4*0.34	Ø5.2mm / BU PVC / PVC	BN,BU,BK,WH	无	80 -40	/ P00	58019252
	58015251-*M	4	4*0.34	Ø5.2mm / BK PVC / PVC	BN,BU,BK,WH	无	80 -40	/ P00	58015251
	58517231-*M	4	4* 0.34	Ø4.6mm / BK PUR / PP 拖链	BN,WH,BU,BK	无	80 -40	/ GSC	58517231
	58028911-*M	4	4* 0.34	Ø5.2mm / BK PUR / PP 屏蔽/拖链	BN,BU,BK,WH	Braid	80 -40	/ S13	58028911
	58697231*M	4	4*0.5	Ø5.2mm / GY PVC / PVC	BN,BU,BK,WH	无	80 -40	/ P00/GY	58697231

## 电缆说明-I/O线缆

电缆	型号	导线数	截面积 (mm <sup>2</sup> )	外径/颜色 护套/绝缘 材质	导线颜色	屏蔽	工作 温度 (°C)	型号 代码	货号
	58014233-*M	4	4*0.34	Ø5.2mm / OR 照射PVC / PVC 抗焊渣	BN,BU,BK,WH	无	105 -40	/ P01	58014233
	58678233*M	4	4*0.34	Ø4.8mm / OR 照射PUR / PP 抗焊渣/拖链	BN,BU,BK,WH	无	105 -40	/ P21	58678233
	58315351-*M	4	4*1.5	Ø7.8mm / BK PVC / PVC	BK,WH,RD,GN	无	80 -40	Blank	58315351
	58301352-*M	4	4*1.5	Ø11.2mm / YE PVC / PVC	BK,WH,RD,GN	无	80 -40	/ 20	58301352
	58078351-*M	5	4*0.34 1*0.5	Ø5.2mm / BK PVC / PVC	BN,BU,BK,WH GN/YE	无	80 -40	/ P00	58078351
	58069351-*M	5	4*0.34 1*0.5	Ø5.2mm / BK PUR / PVC	BN,BU,BK,WH GN/YE	无	80 -40	/ P10	58069351
	58020311-*M	5	5* 0.34	Ø5.2mm / BK PUR / PP 拖链	BN,BU,BK,WH GN/YE	无	80 -40	/ GSC	58020311
	58024231-*M	5	4*0.34 1* 0.5	Ø5.2mm / OR 照射PVC / PVC 抗焊渣	BN,BU,BK,WH GN/YE	无	80 -40	/ P01	58024231
	58118911-*M	5	5*1.5	Ø8.6mm / BK PVC / PVC	BN,BU,BK,WH GN/YE	无	80 -40	Blank	58118911
	58055351-*M	5	5*1.5	Ø5.6mm / GY PUR / PP 拖链	BN,BU,BK,WH GN/YE	无	80 -40	/ 52	58055351
	58045351-*M	8	8*0.25	Ø6.2mm / BK PVC / PVC	BN,BU,WH,GN, YE,GY,RD,PK	无	80 -40	/ P00	58045351
	58032231-*M	8	8* 0.25	Ø6.2mm / BK PUR / PP 屏蔽/拖链	BN,BU,WH,GN, YE,GY,RD,PK	Braid	80 -40	/ S13	58032231
	58092911-*M	11	11*0.75	Ø10mm / BK PVC / PVC 屏蔽	WH,GN,YE,GY,PK RD,BK,VT,BU,BN GN/YE	Foil/Drain	80 -40	/ S10	58092911
	58098911-*M	11	11*0.75	Ø10mm / BK PUR / PP 屏蔽/拖链	WH,GN,YE,GY,PK RD,BK,VT,BU,BN GN/YE	Foil/Drain	80 -40	/ S13	58098911
	58127911-*M	12	12*0.25	Ø7.3mm / BK PVC / PVC	WH,BN,GN,YE,GY PK,BU,RD,OR,TN BK,VT	无	80 -40	/ P00	58127911
	58016351-*M	12	12*0.25	Ø7.3mm / BK PUR / PP 屏蔽/拖链	WH,BN,GN,YE,GY PK,BU,RD,OR,TN BK,VT	Braid	80 -40	/ S13	58016351
	58116911-*M	12	12*0.75	Ø10.5mm /BK PVC / PVC 屏蔽	BN,BU,WH,BN/RD OG,YE,GY,PK,RD BN/WH,BU/WH GN/WH	Foil/Drain	80 -40	/ S10	58116911

电缆	型号	导线数	截面积 (mm <sup>2</sup> )	外径/颜色 护套/绝缘 材质	导线颜色	屏蔽	工作 温度 (°C)	型号 代码	货号
	58099911-*M	14	2*0.5 12*0.25	Ø8.5mm /BK PVC / PVC	0.5=BN,BU 0.25=WH,BN/BU,YE, GY,PK,RD,BK,VT, GY/PK,RD/BU WH/GN,BN/GN	无	80 -40	/ P00	58099911
	58094911-*M	19	3*0.75 16*0.34	Ø10.7mm / BK PVC / PVC	0.75=BN,BU,BN/RD 0.34=WH,BN/BU,YE, GY,PK,RD,BK,VT, GY/PK,RD/BU, WH/GN,BN/GN, WH/YE,YE/BN, WH/GY,GY/BN,	Foil/Drain	80 -40	/ S10	58094911
	58402351-*M	19	3*0.75 16*0.34	Ø10.7mm / BK PUR / PP	(18=BN,BU,BN/RD), (22=WH,BN/BU,YE, GY,PK,RD,BK,VT, GY/PK,RD/BU, WH/GN,BN/GN, WH/YE,YE/BN, WH/GY,GY/BN,	Foil/Drain	80 -40	/ S13	58402351

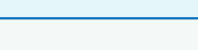
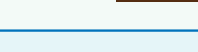
电缆	型号	导线数	截面积 (mm <sup>2</sup> )	外径/颜色 护套/绝缘 材质	导线颜色	屏蔽	工作 温度 (°C)	型号 代码	货号
	58549761-*M EtherCat	4	4*0.14	Ø4.8mm / GN PUR / PE	WH/BU,BU, WH/OG,OG	Foil/Braid 26AWG	80 -40	/ F230	58549761
	58006161-*M Profinet	4	4*0.34	Ø6.5mm / GN PVC/ PE	WH,YE,BU,OG	Foil/Braid 22AWG	80 -40	/ F21	58006161
	58108312-*M Profinet	4	4*0.34	Ø6.5mm / GN PUR/ PE	WH,YE,BU,OG	Foil/Braid 22AWG	80 -40	/ F23	58108312
	58111311-*M Ethernet/IP™	8	4*2*0.25	Ø8mm / GN PVC / PE	WH/GN,GN,WH/OG OG,WH/BU,BU WH/BN,BN	Foil/Braid 24AWG	80 -40	/ E61	58111311
	58121311-*M Ethernet/IP™	8	4*2*0.25	Ø8mm / GN PVC/ PE	WH/GN,GN,WH/OG OG,WH/BU,BU WH/BN,BN	Foil/Braid 24AWG	80 -40	/ E65	58121311
	58016161-*M Ethernet/IP™	8	4*2*0.14	Ø7.2mm / GN PUR/ PE 高柔性	WH/GN,GN,WH/OG OG,WH/BU,BU WH/BN,BN	Foil/Braid 26AWG	80 -40	/ E66	58016161
	58006311-*M Ethernet/IP™	8	4*2*0.26	Ø8mm / GN PVC/ PE	WH/GN,GN,WH/OG OG,WH/BU,BU WH/BN,BN	Foil/Braid 38AWG	80 -40	/ E71	58003311
	58103504-*M 工业以太网线	4	2*2*0.25	Ø5.6mm / TEAL PVC/ PE	WH/GN,GN, WH/OG,OG	Foil/Braid 24AWG	80 -40	/ F41	58103504
	58107501-*M 工业以太网线	4	2*2*0.14	Ø6.1mm / TEAL TPU/ PE	WH/GN,GN, WH/OG,OG	Foil/Braid 26AWG	80 -40	/ F410	58107501
	58110311-*M 工业以太网线	8	4*2*0.14	Ø6.4mm / TEAL PUR / PE	WH/GN,GN,WH/OG OG,WH/BU,BU WH/BN,BN	Foil/Braid 26AWG	80 -40	/ E41	58110311
	58125311-*M 工业以太网线	8	4*2*0.14	Ø6.9mm / TEAL TPU/ PE	WH/GN,GN,WH/OG OG,WH/BU,BU WH/BN,BN	Foil/Braid 26AWG	80 -40	/ E45	58125311

电缆	型号	导线数	截面积 (mm <sup>2</sup> )	外径/颜色 护套/绝缘 材质	导线颜色	屏蔽	工作 温度 (°C)	型号 代码	货号
	58019162-*M Profibus-DP	2	2*0.34	Ø8.0mm/Purple PVC / PE	RD,GN	Foil/Braid 22AWG	80 -40	Blank	58019162
	58028161-*M Profibus-DP	2	2*0.34	Ø8.0mm /Purple TPU / PE 无卤,高柔性	RD,GN	Foil/Braid 22AWG	80 -40	/ 01	58028161
	58221332-*M DeviceNET细缆	4	2*0.34 2*0.25	Ø7.9mm / GY PVC / PE	(BK,RD),(BU,WH)	Foil 24AWG 22AWG	80 -40	/ 10	58221332
	58214311-*M DeviceNET细缆	4	2*0.34 2*0.25	Ø8.5mm / GY TPE / PE 拖链/防焊渣	(BK,RD),(BU,WH)	Foil/Braid 24AWG 22AWG	80 -40	/ 0032	58214311
	58007311-*M DeviceNET 细缆	4	2*0.34 2*0.34	Ø5.7mm / L-GY PVC/PE	(BK,RD),(BU,WH)	Foil 24AWG	80 -40	/ 0024	58007311
	58018161-*M DeviceNET中缆	4	2*1.5 2*0.5	Ø8.4mm / GY PVC / PE	(BK,RD),(BU,WH)	Foil 20AWG	80 -40	/ 0011	58018161
	58201331-*M DeviceNET中缆	4	2*1.5 2*0.5	Ø10.0mm / GY TPE/ PE 拖链/防焊渣	(BK,RD),(BU,WH)	Foil 20AWG	80 -40	/ 0031	58201331
	58200332-*M DeviceNET粗缆	4	2*1.5 2*0.75	Ø12.0mm / GY PVC / PE	(BK,RD),(BU,WH)	Foil/Braid 18AWG	80 -40	Blank	58200332
	58312661-*M DeviceNET粗缆	4	2*1.5 2*0.75	Ø11.5mm / GY TPE / PE 拖链	(BK,RD),(BU,WH)	Foil/Braid 18AWG	80 -40	0027	58312661
	58569661-*M CC-Link	3	3*0.5	Ø7.5mm/ L-BN PVC/ PE	WH,YE,BU	Foil/Braid 22AWG	80 -40	F30	58569661
	58687661-*M CC-Link	3	3*0.5	Ø8 mm/ L-BN PVC/ PE 拖链	WH,YE,BU	Foil/Braid 22AWG	80 -40	F31	58569661
	58501661-*M CC-Link	5	2*0.65 3*0.5	Ø12mm/ L-BN PVC/ PE	(BK,WH)(WH,YE,BU)	Foil/Braid 24AWG	80 -40	S30	58501661

### 电缆安装说明

正确的布线方式能够极大的延长电缆的试用寿命,保证生产线的顺畅操作,减少 停机时间.下面列出一些常见的布线需求,提供简单有效的解决方案.

### 电缆折弯半径

固定装置

标准电缆 :折弯半径=5倍电缆直径



活动装置

标准电缆 :折弯半径=10倍电缆直径



### 安装指导

正确



错误



正确



错误



正确



错误



### 专业定制化

GSEE-TECH认真研究每个行业的行业特点,根据用户的特殊需求,设计,研制,生产更加专业化的连接器,最大程度地帮助用户优化设计方案,节省成本,使整个连接系统更加安全,可靠,稳定。

### 定制化案例

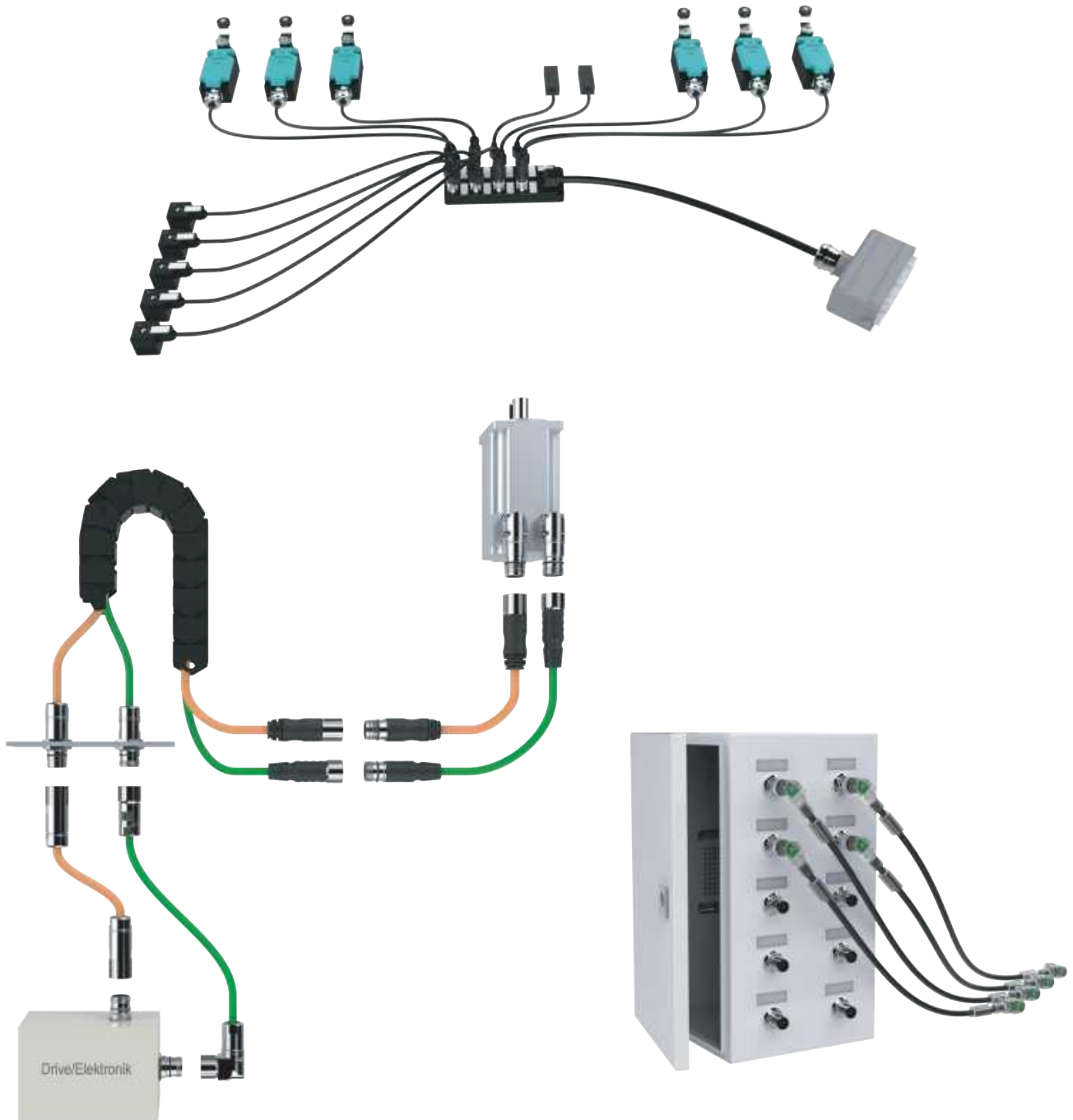

— 连接世界 无限未来 —

 **GSEE | 天津吉诺科技有限公司**

地址：天津市静海经济开发区南区科技路

电话：+86-22-68277298 传真：+86-22-68277161

网址：www.gsee-tech.cn www.gsee-tech.com

Add:Technology Road South Jinghai Economic Development Area Tianjin

Tel:+86-22-68277298 Fax:+86-22-68277161

Url:www.gsee-tech.cn www.gsee-tech.com